

# APWIN

The image displays a comprehensive software interface for audio analysis. At the top, a rack of hardware units is shown. Below it, a large waveform plot displays a signal. To the right, a frequency response plot shows a curve. The interface includes several control panels and windows:

- 96k**: A large red logo indicating the sampling rate.
- Waveform Plot**: Shows a signal waveform with a red cursor.
- Frequency Response Plot**: Shows a curve representing the system's response.
- Control Panels**: Includes settings for Sample Rate (10000 Hz), Resolution (24 Bits), Scale Freq, and Rate (40000 Hz).
- Digital Analyzer**: A window showing analysis parameters like Ch A, Ch B, and various filters.
- Audio Precision**: A window showing a waveform plot and system information.

APWIN USER'S MANUAL

FOR SYSTEM TWO CASCADE



# **APWIN System Two Cascade User's Manual**



Version 1.6  
March, 1999

Copyright © 1999 Audio Precision, Inc.

All rights reserved

Version 1.6 March 1999

No part of this manual may be reproduced or transmitted in any form or by any means, electronic or mechanical, including photocopying, recording, or by any information storage and retrieval system, without permission in writing from the publisher

Audio Precision®, System One®, System Two™, System Two Cascade™, System One + DSP™, System Two + DSP™, Dual Domain®, FASTTEST®, and APWIN™ are trademarks of Audio Precision, Inc. Windows is a trademark of Microsoft Corporation.

*Published by:*



Audio Precision, Inc.  
PO Box 2209  
Beaverton, Oregon 97075-2209  
U.S. Toll Free: 1-800-231-7350  
Tel: (503) 627-0832 Fax: (503) 641-8906  
Email: [techsupport@audioprecision.com](mailto:techsupport@audioprecision.com)  
Web: [www.audioprecision.com](http://www.audioprecision.com)

Printed in the United States of America  
Audio Precision Part Number 8211.0079

# CONTENTS

<b>1. Capabilities</b>	<b>1-1</b>
APWIN Software	1-2
APWIN Tutorial	1-3
Standard Test Files	1-3
Connections to Device Under Test	1-4
Upper-Left Connector Panel	1-4
Upper-Right Connector Panel	1-4
Lower-Left Connector Panel	1-5
Lower Right Connector Panel	1-5
<b>2. System Two Cascade—APWIN Overview</b>	<b>2-1</b>
Screen Overview	2-1
Menu Bar	2-1
Main Workspace	2-2
Status Bar/Tabs	2-2
Toolbar Overview	2-3
Standard Toolbar	2-4
Panels Toolbar	2-5
Procedure Toolbar	2-8
Learn Mode Toolbar	2-9
Browser	2-10
Control and Entry Conventions	2-10
Function Keys	2-12
<b>3. APWIN Menus</b>	<b>3-1</b>
File Menu	3-1

File New . . . . .	3-1
File Open . . . . .	3-1
File Save Test . . . . .	3-6
File Save Procedure . . . . .	3-6
File Save As . . . . .	3-7
File Save All . . . . .	3-10
File Set Working Directory . . . . .	3-10
File Append . . . . .	3-11
File Export . . . . .	3-12
File Import . . . . .	3-15
File Print . . . . .	3-16
File Print Preview . . . . .	3-16
File Print Setup . . . . .	3-16
File Page Setup . . . . .	3-16
File Recent File . . . . .	3-16
File Exit . . . . .	3-16
APWIN File Types . . . . .	3-17
Edit Menu . . . . .	3-18
Undo . . . . .	3-18
Cut . . . . .	3-18
Copy . . . . .	3-18
Paste from clipboard . . . . .	3-19
Copy Panel to Clipboard . . . . .	3-19
Set Analyzer dBr Ref . . . . .	3-20
Set Analyzer Freq Ref . . . . .	3-20
Set Generator dBr Ref . . . . .	3-20
Set Generator Freq Ref . . . . .	3-20
Reset Bar Graph Max/Min . . . . .	3-20
Insert Row Before . . . . .	3-21
Insert Row After . . . . .	3-21
Add Row to the End . . . . .	3-21
Delete Row . . . . .	3-21
View Menu . . . . .	3-21
Standard Toolbar . . . . .	3-22
Panel Toolbar . . . . .	3-22
Procedure Toolbar . . . . .	3-22
Learn Mode Toolbar . . . . .	3-23
Status Bar . . . . .	3-23
Page 1 through Page 5 . . . . .	3-23
Panels Menu . . . . .	3-23
Headphone/Speaker Panel . . . . .	3-24
Procedure Editor . . . . .	3-27
Diagnostic Panel . . . . .	3-27

Regulation Function . . . . .	3-27
Sweep Menu . . . . .	3-32
Show Panel . . . . .	3-33
Show Settling Panel . . . . .	3-33
Start . . . . .	3-33
Stop . . . . .	3-33
Start with Append . . . . .	3-33
Start with Repeat . . . . .	3-34
Transform Data without Acquire . . . . .	3-34
Reprocess Data . . . . .	3-35
Compare Data to Limits . . . . .	3-36
Copy Data 1 Settings to Data 2 Settings and Vice-Versa . . . . .	3-36
Compute Menu . . . . .	3-37
Procedure Menu . . . . .	3-37
Utilities Menu . . . . .	3-37
Restore Hardware . . . . .	3-37
Hardware Status . . . . .	3-38
Utilities Configuration . . . . .	3-38
Utilities Filters . . . . .	3-49
Turn All Outputs Off . . . . .	3-50
Turn Outputs Back On . . . . .	3-50
Clear Log File . . . . .	3-50
View Log File . . . . .	3-50
Multitone Creation . . . . .	3-51
Window Menu . . . . .	3-51
Tile . . . . .	3-51
Arrange Icons . . . . .	3-51
Close All . . . . .	3-51
Help Menu . . . . .	3-51
Index . . . . .	3-52
Using Help . . . . .	3-52
APWIN Basic Language . . . . .	3-52
APWIN Basic Extensions . . . . .	3-53
APWIN Basic Editor . . . . .	3-53
About APWIN . . . . .	3-53
Release Notes . . . . .	3-53
<b>4. Analog Generator . . . . .</b>	<b>4-1</b>
Analog Generator Panel . . . . .	4-1
Waveform Selection . . . . .	4-2
Sine Waveforms . . . . .	4-5
Sine (D/A) . . . . .	4-13

IMD . . . . .	4-15
IMD (D/A) Waveforms . . . . .	4-17
Squarewave . . . . .	4-18
Noise . . . . .	4-19
Arbitrary Waveforms . . . . .	4-22
MLS (Maximum Length Sequence) Waveforms . . . . .	4-23
Special Polarity . . . . .	4-23
Special Pass Thru . . . . .	4-23
Waveform Parameter Interactions . . . . .	4-24
Frequency Control and Units . . . . .	4-24
Fast-High Accuracy Modes . . . . .	4-25
Output On/Off and Channel Selection . . . . .	4-25
Channel Invert . . . . .	4-26
Amplitude Control and Units . . . . .	4-26
Track A . . . . .	4-26
Output Configuration . . . . .	4-27
dBm Reference . . . . .	4-29
dBr Reference . . . . .	4-30
Frequency Reference . . . . .	4-30
Watts Reference . . . . .	4-30
Analog Generator Hardware Overview . . . . .	4-31
System Two Cascade Oscillator Section . . . . .	4-31
Analog Generator Output Stage . . . . .	4-34
<b>5. Analog Analyzer . . . . .</b>	<b>5-1</b>
Analog Analyzer Panel . . . . .	5-1
Input Source Selection . . . . .	5-3
Balanced Input Termination . . . . .	5-3
DC Coupling . . . . .	5-3
Level Meters . . . . .	5-4
Frequency Counters . . . . .	5-4
Input Ranging Control and Manual Selection . . . . .	5-4
Phase Meter Ranges . . . . .	5-5
Input Channel Selection . . . . .	5-6
Function Reading Meter Function Selection . . . . .	5-6
Measurement Standards . . . . .	5-14
Scrape flutter theory of operation . . . . .	5-15
Spectrum analysis of wow and flutter . . . . .	5-16
Function Reading Meter Ranging Control and Manual Selection . . . . .	5-17
Detector Reading Rate Control . . . . .	5-18
Detector Control . . . . .	5-19
High Pass Filter Control . . . . .	5-19

Low Pass Filter Control . . . . .	5-19
Optional Filter Control . . . . .	5-20
Bandpass-Bandreject Filter Steering Control and Manual Frequency Entry Field . . . . .	5-21
dBr References . . . . .	5-21
dBm Reference . . . . .	5-22
Watts Reference . . . . .	5-22
Frequency Reference . . . . .	5-23
Analog Analyzer Hardware Overview . . . . .	5-23
Analog analyzer input configuration . . . . .	5-24
Balanced Inputs . . . . .	5-25
Unbalanced Inputs . . . . .	5-26
Level Meter Hardware . . . . .	5-26
Phase Meter Hardware . . . . .	5-26
Frequency Meter Hardware . . . . .	5-27
Function Reading Meter Hardware Overview . . . . .	5-27
Analog Bandpass/Bandreject Filter Hardware . . . . .	5-28
Function Reading Meter Detector Hardware . . . . .	5-30
Autorange vs. Fixed Range Concepts . . . . .	5-31
<b>6. DSP Overview . . . . .</b>	<b>6-1</b>
A/D and D/A Converters . . . . .	6-3
AES/EBU & Consumer interfaces . . . . .	6-4
<b>7. Digital Domain Testing . . . . .</b>	<b>7-1</b>
Digital Formats . . . . .	7-1
Digital I/O Panel in Digital Domain Testing . . . . .	7-2
Digital Domain Input Signal Selection and Measurement . . . . .	7-3
Peak Monitors . . . . .	7-6
Imbedded Audio Output Features, DIO Panel . . . . .	7-8
Digital Analyzer Panel . . . . .	7-9
<b>8. AES/EBU Interface Testing . . . . .</b>	<b>8-1</b>
Digital I/O Panel . . . . .	8-3
Digital Input Connector/Format . . . . .	8-7
Rate Reference . . . . .	8-8
Error Flag Displays . . . . .	8-8
AES/EBU/EIAJ Input Termination Resistance . . . . .	8-10
Input Sample Rate . . . . .	8-10
Input Voltage . . . . .	8-11
Input Delay from Generator Output . . . . .	8-11
Jitter Measurement . . . . .	8-11
Output Parameters . . . . .	8-12
Output Format . . . . .	8-13



Output Sample Rate . . . . .	8-14
Output Cable Simulation . . . . .	8-16
Output Common Mode Signal . . . . .	8-16
Output Jitter . . . . .	8-17
AES/EBU Preambles . . . . .	8-18
Digital Interface Analyzer . . . . .	8-19
Getting Started Quickly . . . . .	8-19
Panel Controls . . . . .	8-23
Amplitude vs. Time display processing . . . . .	8-23
Jitter Detection . . . . .	8-25
Trigger . . . . .	8-29
Audible Monitoring of Jitter or Imbedded Audio . . . . .	8-31
Windows for FFT Analysis . . . . .	8-32
Averages . . . . .	8-33
Digital References . . . . .	8-33
Example INTERVU Tests . . . . .	8-33
Status Bits Panel . . . . .	8-46
Transmitted Status Bits Channel Selection . . . . .	8-48
Received Status Bytes . . . . .	8-49
Hexadecimal Transmit and Receive . . . . .	8-50
<b>9. Parallel and Serial Interfaces . . . . .</b>	<b>9-1</b>
Parallel Digital Interface . . . . .	9-1
Parallel Port General Information . . . . .	9-1
Parallel Input . . . . .	9-2
Parallel Output . . . . .	9-4
Parallel Interface Connector Pin Assignments . . . . .	9-7
Receive Frame Sync BNC . . . . .	9-8
Transmit Frame Sync BNC . . . . .	9-8
Master Clock Output BNC . . . . .	9-8
Trigger Out BNC . . . . .	9-8
SIA-2322 Serial Interface Adaptor . . . . .	9-9
<b>10. Digital Generator . . . . .</b>	<b>10-1</b>
Digital Generator Waveform Selection . . . . .	10-2
Sine Waveforms . . . . .	10-4
Burst Control . . . . .	10-4
Sine Shaped Burst . . . . .	10-5
Sine Var Phase . . . . .	10-6
Sine Stereo . . . . .	10-6
Sine Dual . . . . .	10-6
Sine + Offset . . . . .	10-7
Sine EQ Sine—Generator Equalization . . . . .	10-7

Squarewave . . . . .	10-9
IMD Test Signals . . . . .	10-10
Noise Waveforms . . . . .	10-11
Special Waveforms . . . . .	10-13
MLS (Maximum Length Sequence) Waveforms	10-16
Arbitrary Waveforms . . . . .	10-17
Frequency Control and Units . . . . .	10-18
Channel Selection . . . . .	10-18
Channel Invert . . . . .	10-19
Track A . . . . .	10-19
Output On/Off . . . . .	10-19
Amplitude Control and Units . . . . .	10-19
Dither . . . . .	10-20
Dither Type . . . . .	10-20
Volts/FS Reference (Digital Generator) . . . . .	10-21
Frequency Reference . . . . .	10-21
dBr Reference . . . . .	10-21
<b>11. DSP Audio Analyzer . . . . .</b>	<b>11-1</b>
DSP Audio Analyzer vs. Hardware Analog Analyzer . . . . .	11-1
DC/AC Coupling and DC Measurements . . . . .	11-3
Input Source Selection . . . . .	11-3
Level Meters . . . . .	11-5
Frequency . . . . .	11-6
Input Range . . . . .	11-6
Function Reading Meter Function Selection, Display, and Units Selection . . . . .	11-6
Function Reading Meter Measurement Functions . . . . .	11-7
Function Reading Meter Ranging . . . . .	11-10
Bandpass/Bandreject Filter Tuning . . . . .	11-10
Highpass Filter . . . . .	11-12
Lowpass Filter . . . . .	11-13
Detector Reading Rate . . . . .	11-13
Detector Type . . . . .	11-14
Weighting Filters (Filtr Field) . . . . .	11-15
Digital References (ANALYZER) . . . . .	11-17
Sweep settings and readings (ANALYZER) . . . . .	11-17
<b>12. Digital Data Analyzer (BITTEST) . . . . .</b>	<b>12-1</b>
Signal Compatibility for BITTEST . . . . .	12-2
Signal Analysis (BITTEST) . . . . .	12-4

- 13. FFT-Based DSP Programs . . . . . 13-1**
  - System Two FFT Function . . . . . 13-1
  - Time Domain Basics . . . . . 13-3
    - Time Domain Display Changes . . . . . 13-3
    - Graphic Resolution vs. Samples . . . . . 13-3
    - Graphic Aliasing . . . . . 13-4
    - Frequency Domain (Spectrum Analysis) . . . . . 13-5
  - FFT Fundamental Relationships . . . . . 13-5
  - Frequency Domain Basics . . . . . 13-6
    - Frequency Domain Display Changes . . . . . 13-7
    - Post-FFT Processing . . . . . 13-9
    - Displayed Points Do Not Equal FFT Bins . . . . . 13-9
    - Transform Data without Acquire . . . . . 13-10
    - Reprocess Data . . . . . 13-11
    - Re-Process FFT Data on Zoom . . . . . 13-11
    - Saving and Loading Waveforms . . . . . 13-12
    - DSP Memory vs. PC Memory . . . . . 13-12
  
- 14. FFT Spectrum Analyzer . . . . . 14-1**
  - General Purpose FFT spectrum analyzer (FFT) . . . . . 14-1
  - Input Source Selection . . . . . 14-2
  - Source . . . . . 14-3
  - Peak Level Monitors . . . . . 14-5
  - Transform Length . . . . . 14-5
  - Acquisition Buffer Length . . . . . 14-5
  - Window Selection . . . . . 14-6
    - Hann Window . . . . . 14-7
    - Blackman Harris Window . . . . . 14-8
    - Flat-Top Window . . . . . 14-9
    - Equiripple Window . . . . . 14-9
    - Hamming Window . . . . . 14-9
    - Gaussian Window . . . . . 14-9
    - Rife-Vincent Windows . . . . . 14-10
    - None (No Window, Rectangular) . . . . . 14-10
    - None, move to bin center (Synchronous FFT of Non-Synchronous Sinewave) . . . . . 14-10
  - Dynamic Range . . . . . 14-12
  - Quasi AC Coupling . . . . . 14-12
  - Averaging . . . . . 14-13
    - Spectrum (Power) Averaging . . . . . 14-14
    - Synchronous Averaging . . . . . 14-16
  - Waveform Display Processing . . . . . 14-20
  - Start Time . . . . . 14-22

Delay (Pre-Trigger) Time . . . . .	14-23
Acquisition Triggering Section . . . . .	14-23
Fixed Sensitivity . . . . .	14-24
Fixed Level . . . . .	14-24
Digital References . . . . .	14-26
Sweep Settings, Readings, and Units . . . . .	14-26
Saving and Loading Waveforms . . . . .	14-28
Saving Waveforms . . . . .	14-29
Loading (Opening) Waveforms . . . . .	14-31
<b>15. Multitone Audio Analyzer . . . . .</b>	<b>15-1</b>
Multitone and Synchronous FFT Concepts . . . . .	15-1
Multitone Signals . . . . .	15-2
Multitone Analysis . . . . .	15-3
Multitone Audio Analyzer . . . . .	15-4
Input Selection . . . . .	15-5
Source Selection . . . . .	15-6
Peak Level Monitors . . . . .	15-8
Measurement . . . . .	15-8
Frequency Resolution . . . . .	15-12
FFT Length . . . . .	15-13
Processing . . . . .	15-13
Triggering . . . . .	15-14
Trigger Delay . . . . .	15-16
Signal Duration Requirements . . . . .	15-16
Channel 2 Phase Display . . . . .	15-18
Sample Rate . . . . .	15-18
Digital References . . . . .	15-19
Sweep Browser Settings and Readings . . . . .	15-19
Phase Display . . . . .	15-21
Saving and Loading Waveforms . . . . .	15-21
Saving Waveforms . . . . .	15-22
Loading Waveforms . . . . .	15-25
Creating Multitone Waveform Files . . . . .	15-26
Main Menu, Multitone Waveform Creation . . . . .	15-27
Frequency List Creation . . . . .	15-29
Use of Existing File for Frequency List . . . . .	15-30
Modification of Data . . . . .	15-30
Sweep Table Definition . . . . .	15-31
Microsoft WAV File Creation . . . . .	15-32
Statistics . . . . .	15-32
Waveform Files, Stereo Separation . . . . .	15-33

- Waveforms for FASTTEST . . . . . 15-33
- 16. Quasi-Anechoic Acoustical Tester (MLS) . . . 16-1**
  - MLS Overview . . . . . 16-1
  - Waveform Display vs. Frequency Response . . 16-2
  - Analog/Digital Signal Acquisition and Analysis 16-2
  - Setting Time Spans . . . . . 16-3
  - Time Span vs. Lowest Usable Frequency . . . 16-4
  - Resolution vs. Time Span . . . . . 16-4
  - Analyzer Panel Fields . . . . . 16-5
  - Input Selection . . . . . 16-5
  - Source Selection . . . . . 16-6
    - Peak Level Monitors . . . . . 16-8
    - Time Delay . . . . . 16-8
    - Time Domain Display—Impulse Response vs. Energy-Time . . . . . 16-9
    - Energy-Time Window . . . . . 16-10
    - Time Windows . . . . . 16-12
    - Wave Display . . . . . 16-13
    - Trigger Source . . . . . 16-14
    - Save and Load MLS Waveforms . . . . . 16-14
    - Dual Channel Operation . . . . . 16-17
    - Generator Sequence Length . . . . . 16-18
    - Matching Generator and Analyzer Sequences 16-18
    - Speed . . . . . 16-19
  - Advanced MLS Theory . . . . . 16-19
    - Impulse Response of Linear Systems . . . . . 16-19
    - Impulse Response from Pseudo-Random Noise . . . . . 16-20
    - Hadamard Transforms . . . . . 16-21
    - Frequency Response From Impulse Response 16-22
    - Time Windows for Time-to-Frequency Transforms . . . . . 16-22
    - Frequency Windows for Energy-Time Displays 16-24
- 17. Sync/Ref Input Panel . . . . . 17-1**
  - Sync/Ref Panel . . . . . 17-3
    - Sync/Ref Input Source and ON/OFF Control . . 17-3
    - Frame Lock . . . . . 17-4
    - Sync/Ref Input Termination . . . . . 17-4
    - Sync Input Frequency Entry . . . . . 17-4
    - Sync Input Frequency Measurement . . . . . 17-5
    - Delay, In from Ref In . . . . . 17-5
    - Sync Unlocked Indicator . . . . . 17-5

Sync Out of Range Indicator . . . . .	17-5
AES/EBU Reference Output . . . . .	17-6
Delay, Out from Ref Out . . . . .	17-6
Invert Frame Sync . . . . .	17-6
Jitter Clock Outputs . . . . .	17-7
<b>18. Measurement Units . . . . .</b>	<b>18-1</b>
AC Amplitude units . . . . .	18-1
dBm vs. dBu Concepts . . . . .	18-4
Ratio Units . . . . .	18-5
Frequency Units . . . . .	18-6
Phase Units . . . . .	18-7
Digital Domain Amplitude Units . . . . .	18-7
Time Units . . . . .	18-8
DCX-127 Amplitude Units . . . . .	18-8
Resistance Units . . . . .	18-8
DCX-127 Digital Input and Output Units . . . . .	18-8
<b>19. Sweeps and Sweep Settling . . . . .</b>	<b>19-1</b>
Source 1 . . . . .	19-3
Sweep Range, Log/Lin . . . . .	19-4
Start-Stop . . . . .	19-4
Log-Lin . . . . .	19-4
Sweep Resolution . . . . .	19-5
X-Axis Divisions (Vertical Grid Lines) . . . . .	19-5
Single-Point "Sweeps" . . . . .	19-6
External Single-Point Sweeps . . . . .	19-6
Go button . . . . .	19-7
Single vs. Repeated Sweeps . . . . .	19-7
Appended Sweeps . . . . .	19-8
External Sweeps . . . . .	19-8
Start, Stop, and Sweep Direction . . . . .	19-10
Min Level . . . . .	19-10
Spacing . . . . .	19-11
End On . . . . .	19-11
Time Sweeps . . . . .	19-12
Table Sweeps . . . . .	19-13
Data 1 and 2 Selection . . . . .	19-15
Top and Bottom . . . . .	19-16
Log-Lin . . . . .	19-17
Number of Divisions (Grid Lines) . . . . .	19-17
Autoscale . . . . .	19-17
Limits . . . . .	19-18

Data 3 Through Data 6 . . . . .	19-18
Plotting Data 3-Data 6 . . . . .	19-18
Stereo Sweeps . . . . .	19-19
Setting Up a Stereo Sweep . . . . .	19-19
Stereo FFTs Following the Analog	
Bandreject Filter . . . . .	19-20
Stereo Sweeps and Limits . . . . .	19-21
External Stereo Sweep . . . . .	19-21
Pre-Sweep Delay . . . . .	19-22
Plotting Measured Values X-Y . . . . .	19-22
Data Display Mode . . . . .	19-23
Source 2 and Nested Sweeps . . . . .	19-24
Timeout . . . . .	19-25
Settling Panel . . . . .	19-25
Settling Concepts and Algorithms . . . . .	19-26
Algorithm Selection . . . . .	19-29
Tolerance and Floor . . . . .	19-29
Delay . . . . .	19-30
Settling Parameter Independence Among	
Instruments . . . . .	19-30
DSP Measurement Settling . . . . .	19-30
<b>20. Graphs and Printing . . . . .</b>	<b>20-1</b>
Zooming . . . . .	20-2
Right Mouse Button Features . . . . .	20-3
Zoomout . . . . .	20-3
Zoomout to Original . . . . .	20-4
Optimize Features, General . . . . .	20-4
Copy to Sweep Panel . . . . .	20-6
Display Cursors . . . . .	20-6
Scroll Bars . . . . .	20-8
Title and Labels . . . . .	20-8
Comment . . . . .	20-9
Graph Legend . . . . .	20-10
Color (Screen Display) . . . . .	20-11
Nested and Appended Sweeps . . . . .	20-12
Reset Colors Cycle Checkbox . . . . .	20-12
Use Test Colors Only Checkbox . . . . .	20-13
Cycle Trace Colors Checkbox . . . . .	20-13
Line Style (Screen Display) . . . . .	20-13
Line Thickness (Screen Display) . . . . .	20-14
Legend Data Column . . . . .	20-14
Legend Axis Column . . . . .	20-14

Legend Source 2 Column . . . . .	20-14
Legend Cursor Columns . . . . .	20-15
Trace Selection . . . . .	20-15
Rows, Legend Size, Column Width . . . . .	20-15
Graph Legend and Data Editor Interaction . . . . .	20-16
Keyboard Control of Graph . . . . .	20-17
Keyboard Access to "Right Button" Features . . . . .	20-18
Keyboard Control of Legend . . . . .	20-18
Bar Graphs . . . . .	20-18
Readings Bargraphs . . . . .	20-20
Settings Bargraphs . . . . .	20-20
Printing . . . . .	20-23
File Print . . . . .	20-24
File Print Setup . . . . .	20-25
File Page Setup . . . . .	20-25
File Print Preview . . . . .	20-32
Printing to a File . . . . .	20-34
<b>21. Limits, Data Editor, and Attached File Editor . . . . .</b>	<b>21-1</b>
Using Data Editor . . . . .	21-1
Legend—Data Editor Interaction . . . . .	21-2
Selecting Rows . . . . .	21-3
Clearing Data, Adding and Deleting Rows . . . . .	21-4
Entering and Modifying Values . . . . .	21-5
Tabular Printout From Data Editor . . . . .	21-5
Exporting ASCII Data . . . . .	21-6
Viewing Data Graphically . . . . .	21-6
Saving Data, Sweep, and Limit Data Files . . . . .	21-6
Creating Limits . . . . .	21-7
Create Data File Columns . . . . .	21-7
Create Data File Rows . . . . .	21-8
Attaching Limit Data Files to Tests . . . . .	21-9
Attached File Editor . . . . .	21-10
Actions Upon Failure . . . . .	21-11
<b>22. Compute Menu . . . . .</b>	<b>22-1</b>
General Operation, Computational Utilities . . . . .	22-1
Compute Normalize . . . . .	22-3
Compute Invert . . . . .	22-4
Compute Smooth . . . . .	22-4
Compute Linearity . . . . .	22-5
Compute Center . . . . .	22-6
Compute Delta . . . . .	22-7



Compute 2-Sigma . . . . .	22-8
Compute Average . . . . .	22-9
Compute Minimum and Compute Maximum . . . . .	22-10
Compute Equalize . . . . .	22-10
Compute Clear All . . . . .	22-11
<b>23. Automating Tests . . . . .</b>	<b>23-1</b>
LEARN Mode . . . . .	23-2
Optimizing Automation Speed . . . . .	23-4
Computer Characteristics . . . . .	23-4
Other Programs Running . . . . .	23-4
Number of Sweep Points . . . . .	23-4
Type of Measurement . . . . .	23-5
Single vs. dual channel (stereo) . . . . .	23-5
Autoranging in analog analyzer vs. fixed range selections . . . . .	23-5
"Keep all readings active" feature . . . . .	23-6
Sweep Settling . . . . .	23-6
Multitone vs conventional swept sinewave testing . . . . .	23-6
Analog hardware analyzer vs. DSP audio analyzer . . . . .	23-7
Bandpass/Bandreject Filter Tracking Methods . . . . .	23-8
Mouse activity during a sweep . . . . .	23-8
Analog vs. DSP-D/A Generator . . . . .	23-8
Loading set-ups as tests vs. changing parameters from a procedure. . . . .	23-9
Time taken by the PC and Windows to draw the various panels and graphs on screen . . . . .	23-9
<b>24. Switchers . . . . .</b>	<b>24-1</b>
APWIN Panel . . . . .	24-1
Input Channel . . . . .	24-2
Output Channel . . . . .	24-3
Output Modes (Switcher) . . . . .	24-3
Switcher Sweep Offsets . . . . .	24-4
Switcher Control During Sweeps . . . . .	24-5
Frequency or Amplitude Sweeps on Many Switcher Channels . . . . .	24-7
Switcher with Multi-Track Recorder . . . . .	24-8
Switcher Hardware . . . . .	24-9
Functional Description . . . . .	24-10
Input Switcher . . . . .	24-10

Output Switcher . . . . .	24-11
Patch Point Switcher . . . . .	24-11
Switcher Jumper Selection . . . . .	24-13
Switcher Installation . . . . .	24-14
Switcher Address Settings . . . . .	24-14
Patch Point Switchers . . . . .	24-16
<b>25. DCX-127 Multifunction Module . . . . .</b>	<b>25-1</b>
Panel . . . . .	25-1
DMM Units . . . . .	25-2
Auto/Fixed Range Checkbox . . . . .	25-2
Fixed Range Selection Field . . . . .	25-2
Offset and Scale Values for f(V), f(O) . . . . .	25-3
DCV/Ohms/Off Selection . . . . .	25-3
Reading Rate . . . . .	25-3
DC Output 1 and 2 On/Off . . . . .	25-3
DC Output 1 and 2 Value . . . . .	25-3
Digital Input Display and Units . . . . .	25-4
Digital Input Data Format Selection . . . . .	25-4
Scale Factor, Digital Input . . . . .	25-4
Digital Output and Units . . . . .	25-4
Digital Output Data Format . . . . .	25-4
Scale Factor for Digital Output . . . . .	25-5
Binary Control for Ports A, B, C . . . . .	25-5
Program Control, Gate Delay . . . . .	25-5
Gate Delay Control for Delayed Trigger . . . . .	25-6
Hardware Discussion . . . . .	25-6
DC Voltage Measurements . . . . .	25-7
Resistance Measurements . . . . .	25-7
DC Voltage Outputs . . . . .	25-8
Digital Input . . . . .	25-9
Digital Output . . . . .	25-10
Program Control Outputs . . . . .	25-11
Digital Control Output Ports . . . . .	25-14
<b>26. Furnished Files . . . . .</b>	<b>26-1</b>
Analog-to-Analog Tests . . . . .	26-1
General Information . . . . .	26-1
Frequency response . . . . .	26-2
Fast Frequency response . . . . .	26-3
Noise (single point) . . . . .	26-4
THD + N vs. frequency . . . . .	26-5
THD + N vs. frequency, Simultaneous	
Two Channels . . . . .	26-6

THD + N vs. amplitude . . . . .	26-7
Spectrum Analysis of Distortion Products After THD + N Notch Filter . . . . .	26-8
SMPTE IMD vs. amplitude . . . . .	26-9
CCIF IMD vs. amplitude . . . . .	26-10
DIM IMD vs. amplitude . . . . .	26-12
Interchannel phase vs. frequency . . . . .	26-13
Input/Output phase . . . . .	26-13
Linearity . . . . .	26-14
Crosstalk vs. frequency . . . . .	26-16
FFT spectrum analysis . . . . .	26-17
Waveform display . . . . .	26-18
External frequency response . . . . .	26-19
External THD + N vs. frequency . . . . .	26-21
Wow & flutter vs. time . . . . .	26-23
Locating -3 dB Point . . . . .	26-24
Measuring Power Bandwidth of a Power Amplifier . . . . .	26-25
Equalized Response of a Phonograph Preamplifier . . . . .	26-26
Multitone Test Suite . . . . .	26-27
Analog-to-Digital . . . . .	26-29
General Information . . . . .	26-29
Frequency response . . . . .	26-31
Fast frequency response . . . . .	26-32
Noise (single point) . . . . .	26-33
THD + N vs. frequency . . . . .	26-34
THD + N vs. amplitude . . . . .	26-34
SMPTE IMD (FFT) . . . . .	26-35
SMPTE IMD vs Amplitude . . . . .	26-37
CCIF IMD (FFT) . . . . .	26-37
DIM IMD (FFT) . . . . .	26-39
Interchannel phase vs. frequency: . . . . .	26-40
Linearity . . . . .	26-41
Crosstalk vs. frequency . . . . .	26-42
FFT spectrum analysis . . . . .	26-43
Waveform display . . . . .	26-44
Multitone Test Suite . . . . .	26-46
Digital-to-Analog . . . . .	26-48
General Information . . . . .	26-48
Frequency response . . . . .	26-51
Fast Frequency response . . . . .	26-52
Noise (single point) . . . . .	26-53

THD + N vs. frequency . . . . .	26-54
THD + N vs. frequency, Simultaneous Two Channels . . . . .	26-55
THD + N vs. amplitude . . . . .	26-56
Spectrum Analysis of Distortion Products After THD + N Notch Filter . . . . .	26-57
SMPTE IMD vs. amplitude . . . . .	26-58
CCIF IMD vs. amplitude . . . . .	26-59
DIM IMD vs. amplitude . . . . .	26-60
Interchannel phase vs. frequency . . . . .	26-62
Linearity . . . . .	26-62
Crosstalk vs. frequency . . . . .	26-64
FFT spectrum analysis . . . . .	26-65
Waveform display . . . . .	26-66
Multitone Test Suite . . . . .	26-68
Digital-to-Digital . . . . .	26-70
General Information . . . . .	26-70
Fast Frequency response . . . . .	26-73
Dual Connector Device, Frequency Response	26-74
Noise (single point) . . . . .	26-75
THD + N vs. frequency . . . . .	26-76
THD + N vs. amplitude . . . . .	26-76
SMPTE IMD vs Amplitude . . . . .	26-77
CCIF IMD . . . . .	26-78
DIM IMD . . . . .	26-79
Interchannel phase vs. frequency . . . . .	26-80
Linearity . . . . .	26-81
Crosstalk vs. frequency . . . . .	26-83
FFT spectrum analysis . . . . .	26-84
Waveform display . . . . .	26-85
Bit Errors with Random Audio Signal . . . . .	26-86
Bit Errors and Hex Amplitudes vs Generator Amplitude, Constant Waveform . . . . .	26-87
Multitone Test Suite . . . . .	26-88
Digital Interface Tests . . . . .	26-90
Total jitter vs. time . . . . .	26-92
FFT of jitter . . . . .	26-93
Waveform of jitter . . . . .	26-94
Interface waveform & jitter . . . . .	26-95
Jitter histogram . . . . .	26-96
Eye pattern . . . . .	26-97
Testing Jitter Tolerance of a Digital Device . . . . .	26-99

Summary of Furnished System Two Cascade Test Files . . . . .	26-101
Analog-to-Analog . . . . .	26-101
Analog-to-Digital . . . . .	26-102
Digital-to-Analog . . . . .	26-103
Digital-to-Digital . . . . .	26-104
Digital Interface Tests . . . . .	26-105

## Capabilities

System Two and System Two Cascade comprise a comprehensive high-performance audio testing system. The basic analog System Two (SYS-2022) tests the amplitude, noise, phase, frequency, and total harmonic distortion plus noise characteristics of analog input/output audio devices. Options may be added for intermodulation distortion (IMD), wow and flutter (W&F), and generation of sinewave bursts,

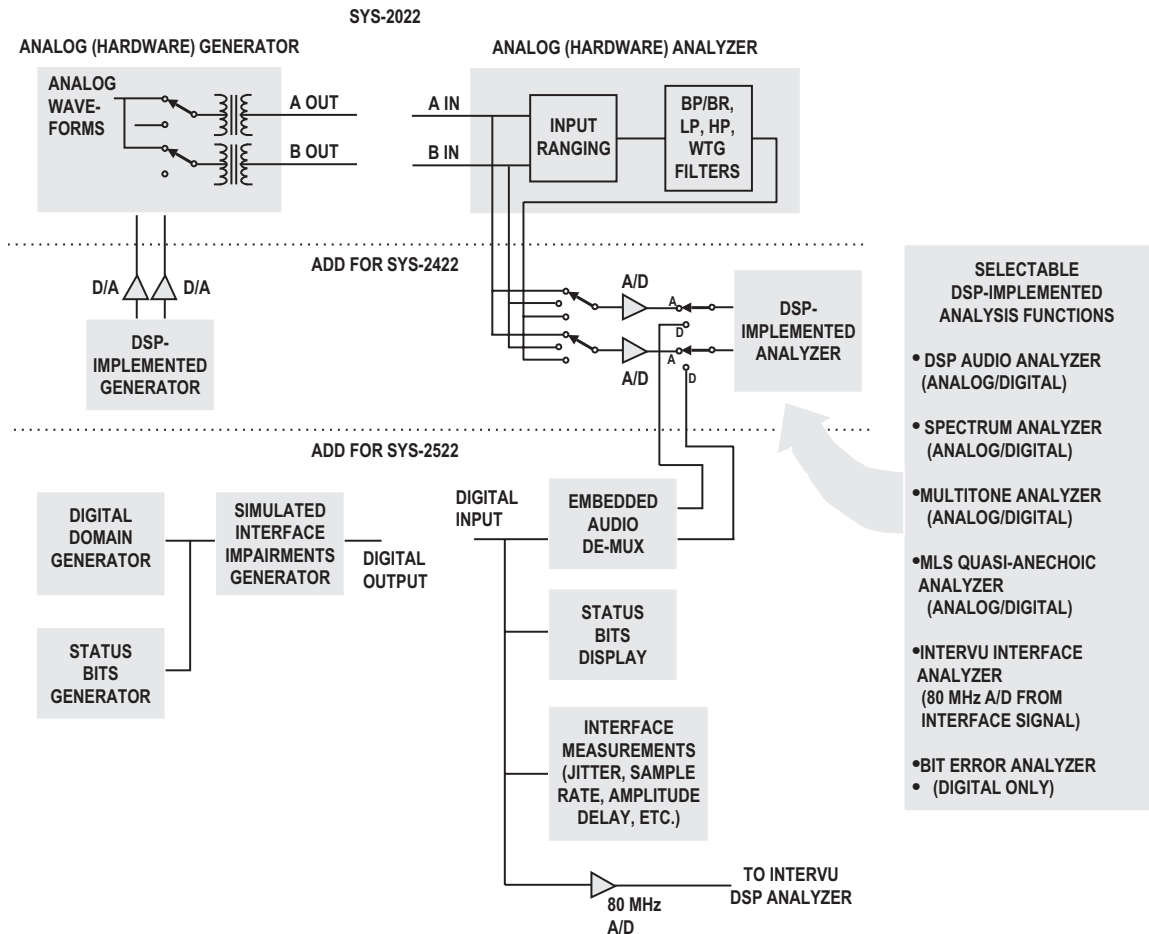

Figure 1-1 Conceptual Block Diagram, System Two

squarewaves, and white and pink noise (BUR). See the Analog Generator and Analog Analyzer chapters of this manual for operational details. System Two Cascade + DSP (SYS-2422) adds a DSP module for enhanced testing of analog devices including very rapid sinewave sweeps (see the DSP Audio Analyzer chapter), FFT spectrum analysis and digital storage oscilloscope operation (FFT Spectrum Analyzer chapter), multitone testing (Multitone Audio Analyzer chapter), and acoustical device testing via MLS (Quasi-Anechoic Acoustical Tester chapter). System Two Cascade Dual Domain (SYS-2522) adds digital input and output capability in the AES/EBU, consumer (SPDIF), and serial and parallel formats for driving and measuring digital inputs and outputs (see the Digital Domain Testing, Digital Generator, DSP Audio Analyzer, and Bit Error chapters), plus extensive measurement of the characteristics of the physical serial input signal (pulse train) and the ability to simulate many types of impairment of the serial pulse train at its digital output (Serial Digital Interface Testing chapter). A digital domain only unit (SYS-2500) has no analog generator or analyzer.

System Two Cascade has no controls or displays on the instrument chassis itself. Instead, System Two Cascade connects to a Windows-compatible personal computer for user interface functions including control, display, sweeps and graphing, results storage, automatic test procedures with Pass/Fail limits, and interface to printers and plotters. The interconnection between System Two Cascade and the computer is via the APIB (Audio Precision Interface Bus) and an ISA-WIN or PCM-WIN interface card for standard ISA slots or PCMCIA slots, respectively. All signal generation and analysis is done in the System Two Cascade chassis, including storage in the DSP module of signals acquired for waveform display or FFT analysis.

---

## APWIN Software

APWIN software operating under Windows 95, Windows 98, or Windows NT supplies all user interface functions. Panels (small Windows) on the APWIN screens are provided for each instrument function such as analog generator, DSP analyzer, accessory signal switchers, and for major functions such as sweep setup, sweep settling control, and data display by X-Y graph or bargraph. APWIN also provides flexible units conversion, translating the basic measured

values from the System Two Cascade chassis into a wide range of units such as dBu, dBV, octaves, decades, and dB below digital full scale. APWIN is graphically-oriented, normally plotting data in real time as a sweep progresses. Instrument setups and acquired data may be saved to disk as test files. Multiple test files may be linked into complete test procedures by use of a Learn Mode which records keystrokes and mouse operations as lines of code. User-created limits may be applied to test results for automatic Pass/Fail decisions by the computer.

APWIN is operated by a combination of techniques which will be familiar to those who have used other Windows applications. APWIN is most-easily operated with a mouse, but keyboard alternatives are available for almost every function. There are typically several alternatives for the most common operations, including toolbar icons for the mouse and keyboard shortcuts. Toolbars permit rapid display of all instrument control and display panels. A menu provides access to all major features. The menu is operable by the mouse or from the keyboard.

---

## APWIN Tutorial

This User's Manual is written primarily as a reference manual containing full details of the operation of System Two Cascade via APWIN software. Thus, it is not organized optimally for initially learning APWIN operation. We strongly urged that first-time or relatively-inexperienced users of APWIN go through the System Two Tutorial booklet. That Tutorial is specifically designed for teaching the usage of System Two and APWIN, starting with basic concepts and building up to more sophisticated techniques. The Tutorial also includes dozens of exercises, most of which use example tests set up expressly for learning purposes.

---

## Standard Test Files

A large number of sample tests are supplied with APWIN and are automatically installed. These tests are intended to provide a quick start into testing typical audio devices. The tests are located under the C:\APWIN\S2 directory. They are further organized into five subdirectories. These directories are "A-a", for testing analog in-analog



out devices, “A-d” for analog input-digital output equipment, “D-a” for digital in-analog out devices, “D-d” for digital i/o devices, and “Dig\_I-O” which contains tests for the digital interface signal itself. Sample procedures are also furnished, including some which perform a quick performance check and more complete diagnostics of the System Two Cascade hardware.

## Connections to Device Under Test

### Upper-Left Connector Panel

The **upper-left** connector panel contains all of System Two’s analog generator output

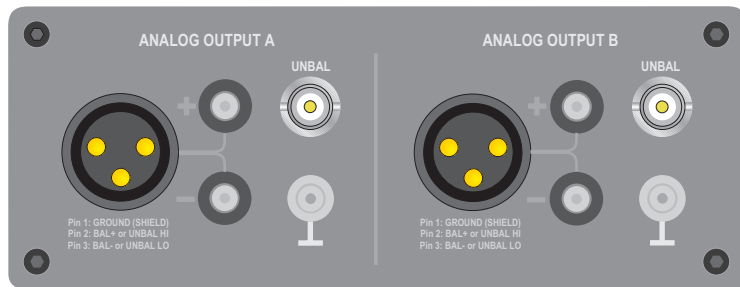

Figure 1-2 Analog Generator (Upper Left) Output Connector Panel

connectors, with Channel A at the left and Channel B at the right. APWIN software panels, described later, permit driving A only, B only, or both simultaneously with both in phase or one inverted with respect to the other. The XLR and double-banana connectors are hard-wired in parallel and thus both are driven in balanced mode. In unbalanced mode, the BNC connector is also driven.

### Upper-Right Connector Panel

The **upper-right** connector panel contains all of System Two’s

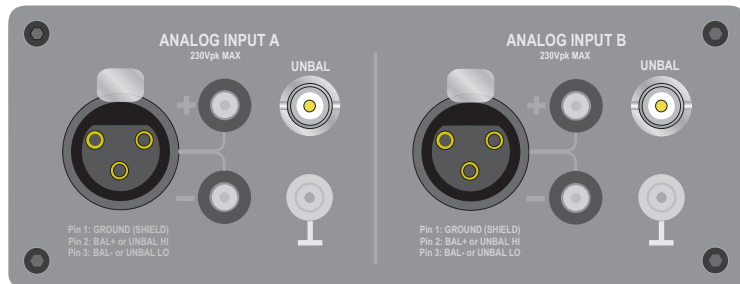

Figure 1-3 Analog Analyzer (Upper Right) Input Connector Panel



BNC input for control of the sine burst option. The four BNCs at the left are connected

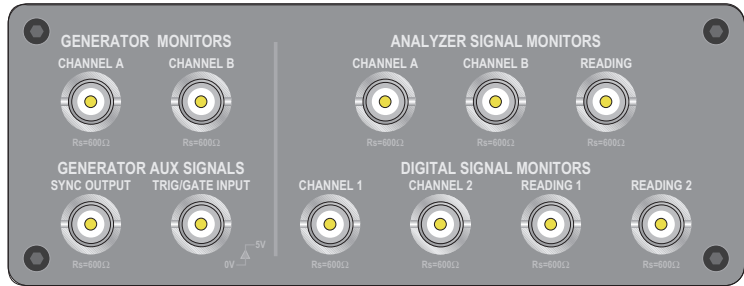

Figure 1-5 Signal Monitor (Lower Right) Connector Panel

to the analog generator. The three BNCs at the upper right connect to the analog analyzer. The four at the lower right connect to the DSP analyzer, with their functions depending on which DSP analyzer program is currently operating.

# System Two Cascade—APWIN Overview

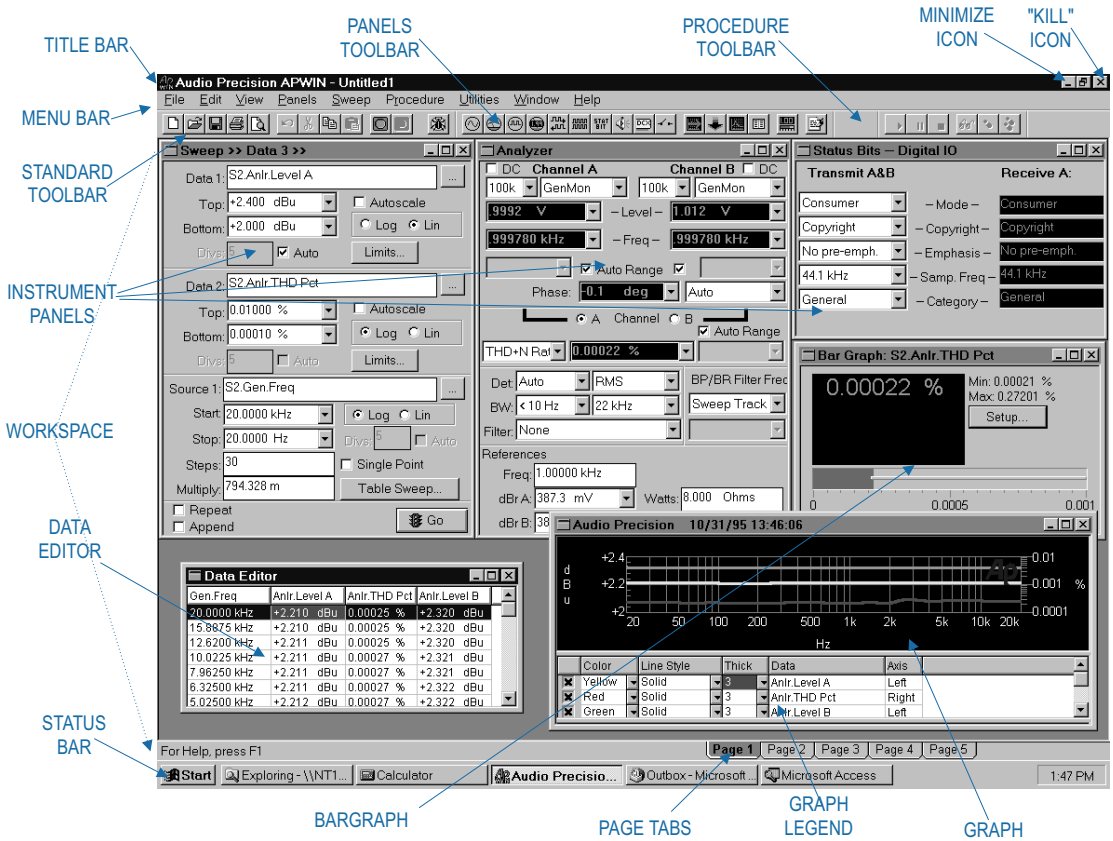

Figure 2-1 APWIN Screen

## Screen Overview

The APWIN Screen consists of the Menu Bar, up to four Toolbars (Standard Toolbar, Panels Toolbar, Procedures Toolbar, and Learn Mode Toolbar), a main Workspace, and the Status Bar with Page Tabs.

### Menu Bar

The Menu bar is immediately below the APWIN Title Bar. It has ten top-level Menu categories—File, Edit, View, Panels, Sweep, Compute,

Procedure, Utilities, Window, and Help. Each category has sub-categories, and in many cases there are further levels below sub-categories. Menu categories are displayed in a drop-down list by clicking on the category name with the left mouse button, or from the keyboard by pressing the **ALT** key simultaneously with the key corresponding to the underlined character in the Menu name. For example, pressing **ALT** **P** selects the Panels category. To select a sub-category, click on the sub-category name with the mouse or press the key corresponding to the underlined character of the sub-category name. To leave a category without making a selection, use the **ESC** key or click anywhere outside the drop-down list box.

The Menu categories and sub-categories are described in individual sections.

## Main Workspace

The main workspace occupies all the screen except for Menu bar, Toolbar, and Status bar. Instrument control panels, graphs, and bargraphs may be freely located in the main workspace. There are five pages of main workspace available, selectable by the **CTRL** **PG****↑** and **CTRL** **PG****↓** keys, by the **CTRL** **1** through **CTRL** **5** key combinations, from the View menu, or by clicking on the Page tabs in the Status Bar/Tab.

## Status Bar/Tabs

The Status Bar and page tabs are located across the bottom of the APWIN screen. The most common message in the Status area is “For Help, press F1”. When the mouse cursor is located on a Toolbar icon for approximately one second (without pressing a mouse button), the Status Bar displays a short message explaining the function of that particular icon.

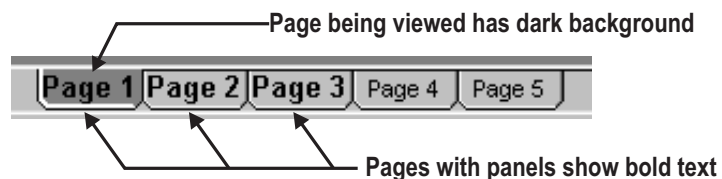

Figure 2-2 Page Tabs on Status Bar

The Page tabs are displayed at the right center of the bar. Clicking on a page tab will cause the contents of that page of the main workspace to be immediately displayed. If one or more panels are displayed on a page, the label on the page tab is displayed in bold characters. The **CTRL** **PG↑** and **CTRL** **PG↓** keys may also be used to step sequentially from page to page, or the **CTRL** **1** through **CTRL** **5** key combinations used to jump directly to a page.

## Toolbar Overview

Four toolbars are primary features of the APWIN screen. These are the Standard Toolbar, the Panels Toolbar, the Procedure Toolbar and the Learn Mode Toolbar. Each toolbar consists of a number of icons that can be clicked to quickly initiate an action or jump to a commonly-used function or panel of APWIN software. When the mouse cursor is held on a Toolbar icon for approximately one second (without pressing a mouse button), a small yellow box (“Tool Tip”) appears at the mouse cursor with the name of the icon, while the Status Bar at the bottom left of the screen also describes the function of the icon.

Each toolbar is “floating” and can be dragged to any desired location on the panel. When the toolbar is dragged to either side of the screen until the mouse cursor touches the screen boundary, the toolbar becomes vertical. It can later be re-oriented as horizontal by dragging it until the mouse cursor touches a top or bottom screen boundary. On screens with sufficient resolution, it is normally most desirable to drag the toolbars to an end-to-end orientation on the same horizontal row. On lower resolution screens, it may be more desirable to orient them in two rows so that scrolling is not necessary to reach any icon. Each toolbar may be displayed or hidden by use of the View Toolbar menu command. If a toolbar is pushed completely off screen by dragging another toolbar, the “lost” toolbar may be returned to the screen by first unchecking its name in the View menu, then re-opening the View menu and re-checking the toolbar name.



*Figure 2-3 Tool Tip  
When Mouse Cursor  
Rests Over Icon*

## Standard Toolbar



The Standard Toolbar icons are briefly described below:



**New:** click on this icon to remove all present panel settings and measurement data and restore the normal APWIN start-up panel settings and panel locations on pages, exactly equivalent to the menu command File New Test



**Open:** click on this icon to display a dialog for navigating through directories (folders) and selecting test file names, exactly equivalent to the menu command File Open Test



**Save:** click on this icon to immediately save the current test (.AT2C) if a name has already been established (equivalent to File Save Test command). If a name has not been established, the Save As dialog will be displayed which permits navigating through directories (folders) and supplying a test file name, exactly equivalent to the menu command File Save As Test





**Save All:** click on this icon to immediately save the current test (.AT2C) and all open procedures (.APB)







**Print:** click on this icon to produce a print-out of the current graph according to the settings of the Print Setup and Page Setup dialogs





**Print Preview:** click on this icon to display the Print Preview screen. If you wish to change attributes of the print-out, use the menu File Page Setup or File Print Setup commands first



Undo: click on this icon  to un-do the last text editing action, equivalent to the Edit Undo ( ) menu command

Cut: click on this icon  to remove the presently selected text to the Windows clipboard, exactly equivalent to the menu command Edit Cut ( )

Copy: click on this icon  to copy the presently selected text to the Windows clipboard without removing it from its present location, exactly equivalent to the menu command Edit Copy ( )

Paste: click on this icon  to copy any text presently on the Windows clipboard to the present mouse cursor location, exactly equivalent to the menu command Edit Paste ( )

Run Sweep (Go): click on this “green light” icon  to start a new sweep, exactly equivalent to the menu command Sweep Start, the  function key, or clicking on the GO button at the bottom of the Sweep Panel

Stop Sweep: click on this “red light” icon  to stop the present sweep, exactly equivalent to the menu command Sweep Stop, the  key, or clicking on the STOP button at the bottom of the Sweep Panel. The toolbar Stop icon and the STOP button on the Sweep panel are available only when a sweep is in progress.

## Panels Toolbar

The Panels Toolbar provides a fast route to displaying any instrument panel and other test-related panels such as Sweep and Sweep Settling. Many of the panels are available in both small and large size versions. Simply clicking on an icon causes it to be displayed







in the small version. Holding down the **SHIFT** key while clicking on the icon produces a display of the large version (if there are two versions). The Panels icons are:

Analog Generator: click on this icon  to display the Analog Generator panel, exactly equivalent to the menu command Panels Analog Generator or the **CTRL G** keystrokes.

Analog Analyzer: click on this icon  to display the Analog Analyzer panel, exactly equivalent to the menu command Panels Analog Analyzer or the **CTRL A** keystrokes.



Digital Generator: click on this icon  to display the Digital Generator panel, exactly equivalent to the menu command Panels Digital Generator or the **CTRL D** keystrokes.

Digital Analyzer: click on this icon  to display the Digital Analyzer panel, exactly equivalent to the menu command Panels Digital Analyzer or the **CTRL Y** keystrokes. Digital features are available only on DSP-based units (System Two Cascade+ DSP and System Two Cascade Dual Domain)

Digital I/O.: click on this icon  to display the Digital Input/Output panel, exactly equivalent to the menu command Panels Digital I/O or the **CTRL I** keystrokes. Digital features are available only on DSP-based units

Sync/Ref Input: click on this icon  to display the Sync/Ref Input panel, exactly equivalent to the menu command Panels Sync/Ref

Input. This panel is functional only on System Two Cascade Dual Domain units

Status Bits: click on this icon  to display the Status Bits panel, exactly equivalent to the menu command Panels Status Bits or the  keystrokes. The Status Bits panel is functional only with a System Two Cascade Dual Domain unit and AES/EBU or consumer interfaced digital devices under test

Headphone/Speaker: click on this icon  to display the Headphone/Speaker panel, exactly equivalent to the menu command Panels Headphone/Speaker

DCX: click on this icon  to display the DCX-127 panel, exactly equivalent to the menu command Panels DCX

Switcher: click on this icon  to display the switcher control panel, exactly equivalent to the menu command Panels Switcher

Sweep: click on this icon  to display the Sweep Panel, exactly equivalent to the menu command Panels Sweep or the  keystrokes.

Sweep Settling: click on this icon  to display the Sweep Settling panel, exactly equivalent to the menu command Panels Sweep Settling

Graph: click on this icon  to display a graph window, exactly equivalent to the menu command Panels Graph

Data Editor: click on this icon  to display the Data Editor, exactly equivalent to the menu command Panels Data Editor

New Bar Graph: click on this icon  to create a new bar graph, exactly equivalent to the menu command Panels Bar Graph

Procedure Editor: click on this icon  to display the Procedure Editor, exactly equivalent to the menu command Panels Procedure Editor or the menu command Procedure Show Panel

## Procedure Toolbar



The Procedure Toolbar icons are:

OLE Automation Browser: click on this icon  to display the OLE Automation Browser, equivalent to the menu command Procedure Browse. This Browser provides an organized list of all APWIN Basic commands for controlling System Two Cascade

Run Procedure: click on this icon  to start the procedure presently loaded, exactly equivalent to the menu command Procedure Run

Pause Procedure: click on this icon  to cause the procedure presently running to halt, exactly equivalent to the menu command Procedure Pause

End Procedure: click on this icon  to stop the procedure presently running, exactly equivalent to the menu command Procedure End

Toggle Break Points: click on this icon  to toggle procedure break points on or off, equivalent to the menu command Procedure Toggle Break Points

Quick Watch: click on this icon , exactly equivalent to the menu command Procedure Quick Watch

Step Into: click on this icon , exactly equivalent to the menu command Procedure Step Into

Step Over: click on this icon , exactly equivalent to the menu command Procedure Step Over

Step Out: click on this icon , exactly equivalent to the menu command Procedure Step Out

## Learn Mode Toolbar



Start Learn Mode: click on this icon , exactly equivalent to the menu commands Procedure Learn Mode or Utilities Learn Mode, to put APWIN into the mode of writing lines of APWIN Basic in the Procedure editor for each user mouse click or panel field entry

Stop Learn Mode: click on this icon , exactly equivalent to un-checking the menu commands Procedure Learn Mode or Utilities Learn Mode, to stop APWIN from writing APWIN Basic code based on user actions.

## Browser

A “Browser” (see Figure 2-4) is a Windows dialog box designed to permit the user to make selections from some organized structure or hierarchy. Browsers at the Sweep panel Source and Data areas permit the user to browse

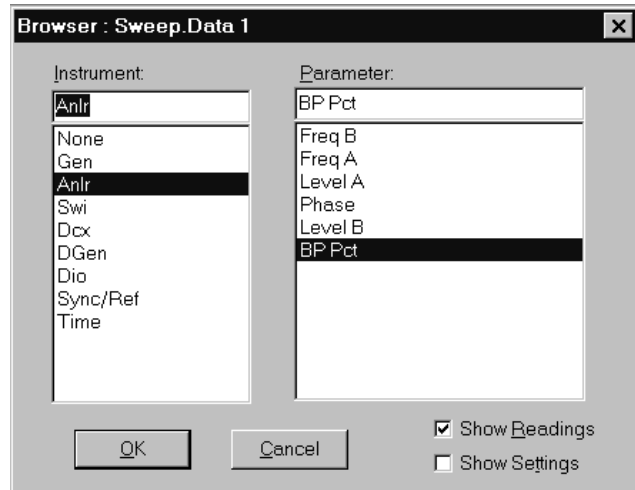

Figure 2-4 Browser for Selecting Instrument Parameter to be Graphed

among different “Instrument” and “Parameter” to find the desired entity to be swept or graphed. File-related browsers permit the user to move up and down among directories and sub-directories (called Folders in Windows 95) and among disk drives to locate the desired file name. File browsers are displayed in response to many common file-related commands including File Open and File Save As.

## Control and Entry Conventions

APWIN uses standard Windows control and data entry conventions. Changes can be made to panel settings only by placing the “focus” on that panel. The “focus” is put on any panel (window) simply by clicking the mouse anywhere on the panel, or by using the **CTRL** **TAB** key combination to move the focus through all the panels (windows) displayed on the present Workspace page. The title bar of the panel with the focus will be blue while the others are gray if the standard Windows default color scheme is used.

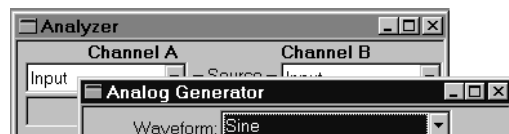









Figure 2-5 Analog Generator Panel Has the Focus, Analyzer Panel Does Not

Many panels may be displayed in either small or large versions. To change between small and large versions, double click anywhere in the title bar (control bar) of the panel. Or, click the mouse on the center of the three upper right icons . Or from the keyboard, use the  or  keys to change between small and large versions.

Multiple-choice fields are indicated by a down arrow at the right end of the field. Clicking the mouse on the down arrow displays the list of available selections. Clicking the mouse on the desired selection makes the change and closes the list. From the keyboard, the  key moves from field to field on a panel, generally in a sequence from upper left to lower right.  moves back upwards on the panel. A selected multiple choice field is indicated by the present entry displayed with inverse video. The  key causes the selection list to display when on a multiple choice field. Operations of the  and  keys then highlight selections, and pressing Enter chooses the highlighted selection.

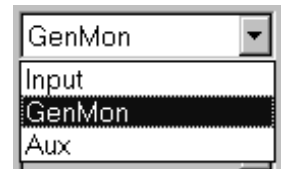

Figure 2-6 Multiple Choice Control



Check boxes may be checked or un-checked by clicking on them with the mouse, or by moving to them with the  or  keys and pressing the Space bar to check or un-check them. Selection of a check box is indicated by a rectangular outline around the label of the checkbox.



Figure 2-7 Checkbox Controls. Lower is Selected







“Radio buttons” are groups of two or more buttons where only one may be selected at any one time. Use the mouse to click directly on the desired radio button. From the keyboard, use the  or  keys to move to a group of radio buttons. Selection is indicated by a rectangular outline around the label of the presently-selected radio button. Use the  or  to change between the buttons in the group.





Figure 2-8 Radio Buttons

Numeric entry fields require that new values be typed in from the keyboard, followed by either the  (which leaves the field selected for further

entries) or the  or  keys (which move to the following or preceding field).

## Function Keys

 Help (context-sensitive if a specific Help topic exists for the panel feature presently selected by the mouse cursor)

 When focus is on a bargraph: re-set the maximum and minimum value storage feature of the presently-selected bargraph

 When focus is on the Data Editor: permit character-by-character editing of Data Editor cell

 Set the analog generator dBr reference value to the present analog generator amplitude setting

 Set the analog generator frequency reference value to the present analog generator frequency setting

 Set the analog analyzer dBr reference value

 Set the analog analyzer frequency reference value to the value presently displayed by the analog analyzer frequency counter

 Perform a new transform on the data presently in the DSP acquisition buffer and graph the results according to the present settings of the Sweep and Digital Analyzer panels

 Graph the present data in DSP memory according to the present settings of the Sweep and Digital Analyzer panels without performing a new transform

 Graph the data presently computer memory

 Start a new sweep; equivalent to clicking on the Go icon in the toolbar or on the Sweep panel

 Start a new sweep while retaining previous data, appending the new to the old

 Start a new repeating sweep

 If a sweep is in progress, pause. If a sweep is paused, start it again (toggle)



Turn off all generator outputs (“panic button”)



Turn back on the generator outputs turned off by 





## APWIN Menus

### File Menu

The File Menu consists of the following commands: New, Open, Save, Save As, Save All, Set Working Directory, Append, Export, Import, Print, Print Preview, Print Setup, Page Setup, a list of recently-used test files, Exit

#### File New

The File New command allows the user to create a new Test or Procedure file, or to erase data from the test file presently loaded.

A Test (.AT2C) file is the fundamental APWIN file that contains complete setup instructions for all fields of all panels, graphs, and bargraphs. The Test file also contains any test data that was present when the file was saved. A new test file is always presented with the small versions of the Analog Generator and Analog Analyzer on page 1, the small version of the Sweep panel plus a graph on page 2, and the small version of the DIO panel on page 3. The File New Test command may also be issued by clicking on the blank sheet icon  on the Standard toolbar.

A Procedure (.APB) file contains a set of instructions in a visual Basic language, which can initiate and control a sequence of actions including loading test files from disk and executing them, comparing data to limits, taking conditional actions, directly changing instrument settings, and a variety of other tasks.

The File New Data command erases all data presently in memory without altering the test setup.

#### File Open

The File Open command displays a subsidiary command menu which allows the user to load from disk into computer memory any

existing file of the Test, Procedure, Data, Limit Data, EQ Curve, Sweep Tables, and Stereo and Mono Waveform types.

The File Open command can be issued by:



clicking on the File menu entry, then clicking on Open in the list box which descends

or

from the keyboard by  (File Open).

Issuing the File Open command displays a “fly-out” command list that permits selection of the file type to be opened. Selecting the desired file type from this list displays the Open dialog box with the desired file type selected, permitting navigation between directories (and disk drives, if necessary) and selection of the specific file name either by typing the name or clicking on a displayed file name.

### File Open Test

The File Open Test command displays a list of the Test files in the current directory. The dialog displayed also permits navigation to other directories or disk drives. A file is opened by selecting the file name and clicking the Open button or by double-clicking the file name. The File Open Test command is identical to clicking on the open folder icon  on the Standard toolbar. The keystrokes  will also display a File Open dialog for Test files, equivalent to File Open Test.

A **Test** (.AT1 for System One, .AT2 for standard System Two, .AT2C for System Two Cascade) file is the fundamental APWIN file that contains complete setup instructions for all fields of all panels, graphs, and bargraphs. The Test file also contains any test data present when the file was saved. A user commonly saves tests whenever a setup or the data resulting from a sweep may be desired at a later time. Audio Precision furnishes a large number of standard, typical tests already set up; see the list of furnished standard test files in the final chapter.

## “Importing” System One Tests

With APWIN operating with System One, only System One (.AT1) files may be opened. When operating with System Two, it is also possible to open System One (.AT1) files in addition to the normal opening of System Two (.AT2) files. Thus, System One files may be imported and then saved as System Two files. Since DOS files (.TST, .LIM, .EQ, etc.) may be imported into APWIN when operating in System One mode by the File Import S1.EXE Test command and saved as .AT1 files, this provides a path from old DOS tests to System Two tests. In a few instances it may be necessary to make modifications to an imported .AT1 file before it will operate System Two hardware correctly, since the architectures of the two instruments are slightly different. To load .AT1 files, click the down arrow at the right of the “Files of Type” field to select whether .AT2 or both .AT1 and .AT2 files will be loaded. Standard System Two cannot load .AT2C files saved from Cascade.



## File Open Procedure

The File Open Procedure command displays a list of the Procedure files (.APB file type) in the current directory. The dialog displayed also permits navigation to other directories or disk drives. A file is opened by selecting the file name and clicking the Open button or by double-clicking the file name.

A **Procedure** (.APB) file contains a set of instructions in a visual Basic language, which can initiate and control a sequence of actions including loading test files from disk and executing them, comparing data to limits, taking conditional actions, directly changing instrument settings, and a variety of other tasks.

## File Open Data

The File Open Data command displays a list of the Data files (.ADA file type) in the current directory. The dialog displayed also permits navigation to other directories or disk drives. A file is opened by selecting the file name and clicking the Open button or by double-clicking the file name.

A **Data** (.ADA) file contains test data only, with no information on panel setup and no definition of display format. To view the newly-loaded data graphically, press the  function key or use the Sweep Compare Data to Limits () command. To view the new data in a tabular presentation, click on the Data Editor icon  or use the Panels Data Editor menu commands.

### File Open Limit Data

The File Open Limit Data command displays a list of the Limit files (.ADL file type) in the current directory. The dialog displayed also permits navigation to other directories or disk drives. A file is opened by selecting the file name and clicking the Open button or by double-clicking the file name.

A Limit Data file is a form of a data file used to define upper or lower limits of acceptable performance, so that automatic pass/fail decisions may be made by the software. See the Limits chapter starting on page 21-1 for more information on Limits.

### File Open Sweep Tables

The File Open Sweep Tables command displays a list of the Sweep Table files (.ADS file type) in the current directory. The dialog displayed also permits navigation to other directories or disk drives. A file is opened by selecting the file name and clicking the Open button or by double-clicking the file name.

A Sweep Table is a form of a data file used to define a list of specific Source 1 values that will be used during a sweep. This contrasts with the software computing Source 1 values based on the Start and Stop values, Log/Lin selection, and number of steps or step size. See the Table Sweeps section in the Sweeps chapter for more information.

### File Open EQ Curve

The File Open EQ Curve command displays a list of the EQ Curve files (.ADQ file type) in the current directory. The dialog displayed also permits navigation to other directories or disk drives. A file is opened

by selecting the file name and clicking the Open button or by double-clicking the file name.

An EQ (equalization) Curve is a form of a data file used to define a relationship between amplitude and frequency. It may be used to automatically control a generator amplitude during a sweep so as to follow the equalization curve. See the equalization sections of the Analog Generator chapter and Digital Generator chapter for more information. The EQ Curve may also be used by the Compute Equalize function to modify data following a sweep to the values it would have had if the equalization curve had been in use. See the Compute Equalize section in the Compute chapter for more information. EQ Curves furnished by Audio Precision are located in the C:\APWIN\EQ directory.

### File Open Stereo Waveforms

The File Open Stereo Waveforms command displays a list of previously-acquired and saved Stereo Waveform files (.AAS file type) in the current directory. The dialog displayed also permits navigation to other directories or disk drives. A file is opened by selecting the file name and clicking the Open button or by double-clicking the file name.

Stereo waveforms files are files containing two channels of previously-acquired signal which had been saved to disk for later use. The Open Stereo Waveform command loads such a file into both channels of the DSP analyzer where it may be further viewed in time or frequency domain representations. For more information on saving and loading waveforms, see the chapter for the specific FFT-based analyzer program in use.

### File Open Mono Waveforms

The File Open Mono Waveform command displays a list of the Mono Waveform files (.AAM) in the current directory. The dialog displayed also permits navigation to other directories or disk drives. A file is opened by selecting the file name and clicking the Open button or by double-clicking the file name.

Mono waveforms files are files containing one channel of previously-acquired signal which had been saved to disk for later use. The Open Mono Waveform command loads such a file into either channel (as selected by the user) of the DSP analyzer where it may be further viewed in time or frequency domain representations. For more information on saving and loading waveforms, see the chapter for the specific FFT-based analyzer program in use.

## File Save Test

The File Save command displays a subsidiary “fly-out” menu with the further choices of Test and Procedure. The File Save Test command allows the user to save to disk the test setup information and data currently in memory. The File Save Test command may also be issued by clicking on the diskette icon  on the Standard toolbar

or

from the keyboard by pressing     (for File Save Test).

If the test in memory was previously loaded from disk (via File Open) or previously saved and thus already has a name, the current information will be saved under that existing name, over-writing the previous version of the same named test.

If no test name has been assigned, the Save As dialog box appears. The Save As dialog box is similar to the File Open dialog box. Normal operation of System Two Cascade results in saving test files with the .AT2C extension. If APWIN was started in the special System Two Compatibility mode, the files will be saved with an .AT2 extension.

## File Save Procedure

The File Save command displays a subsidiary “fly-out” menu listing the choices Test and Procedure. Selecting the Procedure command saves the procedure presently in the Procedure Editor to disk. The File Save Procedure command may also be issued by the keystrokes

   

or by clicking on the diskette icon on the Procedure Editor panel.

## File Save As

Issuing the File Save As command displays a “fly-out” command list which permits selection of the file type to be saved from the choices Test (.AT2C), Procedure (.APB), Data (.ADA), Limit Data (.ADL), Sweep Tables (.ADS), EQ Curve (.ADQ), Stereo Waveform (.AAS), or Mono Waveform (.AAM). Selecting the desired file type from this list displays the Save As dialog box, permitting navigation between directories (and disk drives, if necessary) and displaying existing file names of the type being saved.

If the file presently in memory was previously loaded from disk (via File Open) or previously saved and thus already has a name, that name will be suggested. If accepted by the user, current data will be saved under that existing name, over-writing the previous version of the same named test.

A test file includes all instrument setups, Sweep panel and Sweep Settling settings, Graph settings, Page Setup settings for graph print-out, etc., etc., plus measurement data from the last  operation before saving. Data, Limits, Sweep, and EQ files save only the measurement data and certain Sweep panel information. The Procedure file saved consists of the contents of the Procedure Editor. The Waveform selections save the contents of one or both FFT Acquisition Buffers as selected in the dialog box displayed after the file name is entered or selected. Stereo Waveform files have two waveforms and Monaural Waveforms contain only one.

## File Save As Test

The File Save As Test command permits saving present instrument and sweep setup information, plus any test data present if a test has already been run, as a Test file (.AT2C). If APWIN was started in the special System Two Compatibility mode, the files will be saved with an .AT2 extension. The file will be saved in the current directory or the dialog permits navigation to other directories or disk drives.





## File Save As Procedure

The File Save As Procedure command permits saving the contents of the Procedure Editor as a Procedure file (.APB file type) in the current directory. The dialog displayed also permits navigation to other directories or disk drives.

A Procedure (.APB) file contains a set of instructions in APWIN Basic language, which can initiate and control a sequence of actions including loading test files from disk and executing them, comparing data to limits, taking conditional actions, directly changing instrument settings, and a variety of other tasks.

## File Save As Data

The File Save As Data command permits saving the present test results data as a Data file (.ADA file type) in the current directory. The dialog displayed also permits navigation to other directories or disk drives.

A Data (.ADA) file contains test data only, with no information on panel setup and no definition of display format. To view the newly-loaded data graphically, press the  function key or use the Sweep Compare Data to Limits () command. To view the new data in a tabular presentation, click on the Data Editor icon  or use the Panels Data Editor menu commands.

## File Save As Limit Data

The File Save As Limit Data command permits saving the data points presently in the Data Editor as a Limit file (.ADL file type) in the current directory. The dialog displayed also permits navigation to other directories or disk drives.

A Limit Data file is a form of a data file used to define upper or lower limits of acceptable performance, so that automatic pass/fail decisions may be made by the software. For more information on Limits, see the Limits chapter beginning on page 21-1.

## File Save As Sweep Tables

The File Save As Sweep Tables command permits saving the data points presently in the Data Editor as a Sweep Table file (.ADS file type) in the current directory. The dialog displayed also permits navigation to other directories or disk drives.

A Sweep Table is a form of a data file used to define a list of specific Source 1 values which will be used during a sweep, as opposed to the software computing Source 1 values based on the Start and Stop values, Log/Lin selection, and number of steps or step size. See the Table Sweeps section of the Sweep chapter for more information.

## File Save As EQ Curve

The File Save As EQ Curve command permits saving the data points presently in the Data Editor as an EQ Curve file (.ADQ file type) in the current directory. The dialog displayed also permits navigation to other directories or disk drives.

An EQ (equalization) Curve is a form of a data file used to define a relationship between amplitude and frequency. It may be used to automatically control a generator amplitude during a sweep so as to follow the equalization curve. See the equalization sections of the Analog Generator chapter and Digital Generator chapter for more information. The EQ Curve may also be used by the Compute Equalize function to modify data following a sweep to the values it would have had if the equalization curve had been in use. See the Compute Equalize section in the Compute chapter for more information. EQ Curves furnished by Audio Precision are located in the C:\APWIN\EQ directory.

## File Save As Stereo Waveform

The File Save As Stereo Waveform command permits saving to disk the sampled signal presently in both channels of the DSP acquisition buffers. The resulting disk file may later be downloaded to the DSP via the Open Stereo Waveform command so that it may be further viewed in time or frequency domain representations. For more

information on saving and loading waveforms, see the chapter on the FFT-based analyzer program in use.

## File Save As Mono Waveform

The File Save As Mono Waveform command permits saving to disk the sampled signal presently in one channel of the DSP acquisition buffers. The resulting disk file may later be downloaded to either channel of the DSP via the Open Mono Waveform command so that it may be further viewed in time or frequency domain representations. For more information on saving and loading waveforms, see the chapter on the FFT-based analyzer program in use.

## File Save All

The File Save All command saves to disk both the current test and all currently-open procedures. The File Save All command may be issued by:

Selecting File menu and the Save All command

or

Typing    (File save aLL) from the keyboard

or

Clicking on the multi-diskette icon  on the Standard Toolbar

## File Set Working Directory

APWIN tests often include a number of linked files, including Sweep Tables, Limit files, and (for DSP versions) generator waveform files. The “Current Working Directory” is the directory where APWIN expects to find files that do not have an explicit path name supplied. The Set Working Directory command displays a disk and sub-directory navigation dialog that permits the user to specify the current working directory. This supports one possible disk organization philosophy of grouping the test files, limit files, sweep tables, etc. for different testing activities into different directories, such as a power amplifier directory or a directory for a specific product model number.

If an explicit path name is furnished for a linked file when a test is set up, APWIN expects to find the file in that specific directory instead of the current working directory. If, for example, different directories have been set up for different products or models but all use the same generator arbitrary waveform file, the waveform file name and explicit path may be specified as each test is set up so that it is not necessary to store duplicate copies of the waveform file in many directories.

By default, all File Open commands initially display the current working directory contents. The user may navigate to other directories if desired. Opening a **test** file in a different directory will re-set the current working directory. The File Save As command is independent from the current working directory and will display the contents of the last directory used by this command.

The current working directory is stored when exiting from APWIN and will automatically be used the next time APWIN is started. Note that the current working directory established for APWIN is independent of the current working directory of all other Windows applications.

## File Append

The data in existing disk files may be appended to the data presently in memory so that old and new traces may be viewed simultaneously. Data in test files (.AT1, .AT2, or .AT2C) and data files (.ADA, .ADQ, .ADS, and .ADL) may be appended. The File Append menu command displays a dialog with a Browser, permitting navigation to any directory and bringing in the data from files of any of those six types. APWIN will not permit appending of data unless the file on disk and the file presently in memory:

- have compatible Source 1 selections (for example, both frequency or both amplitude but not one frequency and the other amplitude)
- have the same structure of Data 1 and Data 2 selections. For example, a disk file with data plotted at both Data 1 and Data 1 may not be appended to data in memory which is graphed only as Data 1 with Data 2 set to “None”

- have compatible measurement “domains”. For example, measurements of distortion in percent units may not be appended to measurements of level in amplitude units, but distortion data in absolute units (Volts, dBu, etc.) may be appended to amplitude data

The appended data will be graphed in the same trace color used in the original test or data file from which it was extracted, but the color may then be changed by use of the Graph Legend. Original and appended data may be viewed in the Data Editor.

## File Export

---

The File Export menu command displays a “fly-out” dialog with two additional choices—ASCII Data and Graphics.

### File Export ASCII Data

This command saves the test data presently in memory in the Export Data File format (.ADX file type) in order to easily import it into other software programs. The .ADX file consists of ASCII characters with commas as delimiters. The basic structure is similar to the format displayed in the Data Editor. For standard (not nested) sweeps, the columns from left to right are Source 1 followed by the Data columns. For a nested sweep, the columns are Source 1, the Data columns, and Source 2. Examples of both standard and nested sweep .ADX files are shown below for cases of two Data parameters, Anlr Level A at Data 1 and Anlr THD at Data 2. Use of Data 3 through Data 6 would add additional columns. Unused data columns are represented by commas.

## Normal Sweep

C:\APWIN\SAMPLES\EXAMPLE.AT1, 08/22/95 11:09:55

Gen.Freq,	Anlr.Level A,	Anlr.THD Ratio,	''''
Source 1,	Data 1,	Data 2,	''''
Hz,	dBV,	%,	''''
20000,	0.038598,	0.000387,	''''
5025,	0.031718,	0.000426,	''''
1262,	0.024833,	0.000348,	''''
317,	0.028276,	0.000348,	''''
79.625,	0.024833,	0.00031,	''''
20,	0.020526,	0.000378,	''''

## Nested Sweep

C:\APWIN\SAMPLES\EXAMPLE2.AT1, 08/22/95 11:13:23

Gen.Freq,	Anlr.Level A,	Anlr.TH Ratio	,,,,	Gen.Ampl
Source 1,	Data 1,	Data 2,	,,,,	Source 2
Hz ,	dBV,	%,	,,,,	Vrms
20000,	0.031718 ,	0.000387,	,,,,	1
5025,	0.024833 ,	0.000426,	,,,,	1
1262,	0.021388,	0.000349,	,,,,	1
317,	0.024833 ,	0.000348,	,,,,	1
79.625,	0.017942 ,	0.000349,	,,,,	1
20,	0.018803 ,	0.00032,	,,,,	1
20000,	7.990518 ,	0.00034,	,,,,	2.5
5025,	7.990518 ,	0.000341,	,,,,	2.5
1262,	7.98501,	0.000279,	,,,,	2.5
317,	7.98501,	0.000279,	,,,,	2.5
79.625,	7.97674 ,	0.000372,	,,,,	2.5
20,	7.979499,	0.000287,	,,,,	2.5

## File Export Graphics

The File Export Graphics command creates a Windows Metafile or Enhanced Metafile copy of the present graph as a disk file. A dialog permits navigation to any desired directory and supplying a file name for the Metafile. A Metafile is a standard graphics format of the vector type, as opposed to bitmaps. Metafiles can be imported into most drawing, desktop publishing, and word processing programs. Resolution of a Metafile depends only on the output device, as opposed to a bitmap whose resolution in pixels is fixed at the moment of capture. The Enhanced Metafile (.emf file type) contains more information than the original Windows Metafile (.wmf file type) and is preferred when the program into which it will be imported will accept it. Older Windows programs may accept only the original (.wmf) format. The parameters of the Metafile graph (trace line styles, trace color, trace thickness, whether comments and legend are part of the metafile, etc.) are controlled from the File Page Setup screen.

As an alternate to the Metafile file for graph export, metafiles or bitmap copies of graphs (and bitmap copies of other panels) may be copied to the Windows clipboard by the Edit Copy to Clipboard command.

## File Import

The File Import command produces a menu of three subsidiary selections: ASCII data, S1.EXE test, and S1.EXE procedure. The two S1.EXE choices will be gray and unavailable when APWIN has been started for System Two Cascade, but are available when started for System One.

### Importing ASCII Data

Popular spreadsheet software, text editors, and the Audio Precision MAKEWAV3 utility (for generating multitone waveform files) can generate ASCII data files. The S1.EXE files may be imported only if APWIN has been started in its System One mode.

The File Export ASCII Data description above shows examples of the format of the comma-delimited file format. Spreadsheet software can create such comma-delimited files, with the first four lines of text typed in manually or pasted in from an .ADX file via the Windows clipboard.

The File Import dialog box permits the user to specify whether .ADX or .ADF files are shown in the browser. The format of these two file types is identical. The .ADX file type is automatically created when the File Export command is used from APWIN. The .ADF file type is automatically created when MAKEWAV3 generates its list of exact fundamental frequencies in a multitone file.

### Importing S1.EXE Files

Importing S1.EXE files makes it possible to transfer test setups originally prepared with DOS software to the Windows environment with APWIN. They may then be saved as .AT1 files. Importing a DOS procedure will also automatically import the test, limit, sweep, etc. files, resulting in a complete operating procedure for System One under APWIN.



---

## File Print

---

See the Graphs and Printing chapter.

---

## File Print Preview

---

See the Printing Graphs section of the Graphs and Printing chapter.

---

## File Print Setup

---

The File Print Setup command permits selection of the printer to be used, the paper orientation (landscape versus portrait), and the paper size and source on printers which have multiple paper trays. To display the Print Setup dialog box:

select Print Setup under the File menu

or

from the keyboard, press the    keys (for File pRint setup). Note that Print Setup sets the configuration for APWIN only, and does not affect other Windows programs.

---

## File Page Setup

---

See the Page Setup section of the Graphs and Printing chapter.

---

## File Recent File

---

The names of the eight most-recently-used test files (.AT1, .AT2, or .AT2C) are listed in the lower section of the File menu. Any files of those files (of the type corresponding to the instrument in use) may be opened by a single click of the left mouse button on the file name. This is particularly convenient when working repetitively with a small number of test files, particularly if some of them are located in different directories (folders) from others.

---

## File Exit

---

The File Exit command terminates an APWIN session. To execute this command:

click on Exit under the File menu

or

from the keyboard, press    (for File eXit).

Another alternative method for ending an APWIN session is by clicking the  icon at the upper right of the screen.

## APWIN File Types

APWIN uses a number of different types of files, distinguished both by their internal structure and by the file extension (three characters following the “.”). All extensions use the letter “A” (for Audio Precision) as the first character. They are:

### Test Files

Test File, System One	.AT1
Test File, System Two	.AT2
Test File, System Two Cascade	.AT2C

### Data Files

Test Results Data	.ADA
Limits Data	.ADL
Sweep (Step) Table	.ADS
EQ Curves	.ADQ
Exported (delimited ASCII) Data	.ADX
MAKEWAV2 Exact Fundamental Frequency List	.ADF

### DSP Files

DSP Program, System One	.AZ1
DSP Program, System Two	.AZ2
Acquired Waveform, 1 channel	.AAM
Acquired Waveform, 2 channels	.AAS
Generator Waveform, 1 channel	.AGM
Generator Waveform, 2 channels	.AGS

### Miscellaneous Files

APWIN Basic Procedure	.APB
Log File	.ALG
Waveform Statistics File from Multitone Creation	.WFS
Sweep Table Statistics File from Multitone Creation	.STS

Note that Data, Limit, Sweep, and EQ Curve files all have identical formats and may be used interchangeably.



## Edit Menu

---

The Edit Menu consists of the following commands: Undo, Cut, Copy, Paste, Copy Panel to Clipboard, Set Analyzer dBr Reference, Set Analyzer Frequency Reference, Set Generator dBr Reference, Set Generator Frequency Reference, Reset Bargraph Max/Min, Insert Row Before, Insert Row After, Insert Row at End, and Delete Row.



### Undo

---

The Edit Undo command (equivalent to the  icon on the Standard Toolbar or the  keystrokes) will undo the last deletion or typing action in the various text editors such as the Comments Editor or Procedure editor. A second operation will undo the undo.



### Cut

---



The Cut command (equivalent to the  icon on the Standard Toolbar or the  keystrokes) removes selected text from an editor such as the Comments or Procedure editors, or from a numeric entry field, to the Windows clipboard. Selected text is indicated by inverse video. The text may then be pasted into another location or another Windows program.

### Copy



---

The Copy command (equivalent to the  icon on the Standard Toolbar or the  keystrokes) copies selected text (inverse video highlighted) from an editor such as the Data Editor, Comments Editor, or Procedure Editor, or from a numeric entry field on a panel, to the Windows clipboard. The text may then be pasted into another location or into another Windows program. To copy a selected graph or panel to the clipboard, use the Edit Copy Panel to Clipboard command instead.

## Paste from clipboard

The Paste command (equivalent to  icon on the Standard Toolbar or the  keystrokes) duplicates at the current cursor location the text presently on the Windows clipboard. That clipboard text would have been placed there by using the Cut or Copy command to bring the text from another location within APWIN, or from another Windows program. When pasting into a numeric entry field such as generator Amplitude or Sweep Start, the Enter key must be pressed to cause actual data entry if the “Auto Enter for Numeric Fields” checkbox of the Utilities Configuration General tab is not checked. Note that pasting numeric data with “illegal” units into a numeric entry field will result in an error message and retention of the previous entry. For example, it is not possible to paste a frequency value in Hz units into an Amplitude field.

## Copy Panel to Clipboard

The Copy Panel to Clipboard command in the Edit menu will copy to the Windows clipboard the APWIN panel, graph, bargraph, or editor (Window) that presently has the focus. The focus is placed on a panel, graph, etc. by clicking on the panel or, if no mouse is available, using the  keystroke. The panel with the focus has a blue title bar at the top. From the clipboard, it may then be copied into any Windows-compliant application by the Paste command of that application (or ). Thus, a copy of a graph, bargraph, editor, or instrument panel may be easily placed into a word processing document or paint or graphics program for further processing or printing. Note that the  keystroke will not copy a panel or graph since that keystroke is defined for text copy among APWIN's editors; the Edit Copy to Clipboard command must be used.

All panels except for the graph are always copied as bitmaps. The graph may be copied, at the user's choice, as a bitmap or metafile. A bitmap is a fixed-resolution format, with the pixel relationship determined when the panel or graph is captured. The bitmap graph background will be black, duplicating the on-screen version. A metafile is a vector format. The resolution is determined by the final output or display device, independent of what the size or screen resolution was

then the graph was captured. The choice between copying to the clipboard as a black-background bitmap or a white-background metafile is determined on the Graph tab of the Utilities Configuration dialog.

Note that a metafile copy of the APWIN graph can also be obtained as a separate file, rather than temporarily copied to the Windows clipboard, by the File Export Graphic command.

---

### Set Analyzer dBr Ref



---

The Set Analyzer dBr Reference command (equivalent to the  key) causes the presently-measured analog amplitude value to be written into the dBr reference field near the bottom of the large form of the Analog Analyzer panel. This is often referred to as “setting zero dBr”.

---

### Set Analyzer Freq Ref

---

The Set Analyzer Frequency Reference command (equivalent to the   keystrokes) causes the presently-measured frequency value to be written into the Frequency Reference field near the bottom of the large form of the Analog Analyzer panel.

---

### Set Generator dBr Ref



---

The Set Generator dBr Reference command (equivalent to the  key) causes the presently-set analog generator output amplitude to be written into the dBr Reference field near the bottom of the large form of the Analog Generator panel.

---

### Set Generator Freq Ref

---

The Set Generator Frequency Reference command (equivalent to the   keystrokes) causes the presently-set analog generator frequency to be written into the Frequency Reference field near the bottom of the large form of the Analog Generator

---

### Reset Bar Graph Max/Min

---

The Reset Bar Graph Max/Min command (equivalent to the  function key) causes the maximum and minimum hold feature of the

Bargraph which has the Windows focus to reset to the currently-measured value. Windows focus is indicated by the title bar across the top of the bargraph being blue rather than gray. Clicking anywhere on a bargraph brings the Windows focus to it.

---

### **Insert Row Before**

---

When the Data Editor has the focus (Data Editor Title Bar is blue), the Insert Row Before command will insert a new row into the Data Editor, immediately before the presently-selected row. The same function is also available as a right mouse button selection when the mouse cursor is in the Data Editor.

---

### **Insert Row After**

---

When the Data Editor has the focus (Data Editor Title Bar is blue), the Insert Row After command will add a new row into the Data Editor, immediately after the currently-selected row of data. The same function is also available as a right mouse button selection when the mouse cursor is in the Data Editor.

---

### **Add Row to the End**

---

When the Data Editor has the focus (Data Editor Title Bar is blue), the Add Row to the End command will add a new row of data at the end of the Data Editor. The same function is also available as a right mouse button selection when the mouse cursor is in the Data Editor.

---

### **Delete Row**

---

When the Data Editor has the focus (Data Editor Title Bar is blue), the Delete Row command will delete the currently-selected row of data. The same function is also available as a right mouse button selection when the mouse cursor is in the Data Editor.

---

## **View Menu**

---

The View Menu consists of the following commands: Standard Toolbar, Panel Toolbar, Procedure Toolbar, Learn Mode Toolbar, Status Bar, Page 1, Page 2, Page 3, Page 4, Page 5

## Standard Toolbar

---

The Standard Toolbar (illustrated in chapter 2) contains icons for common activities such as opening and saving files, printing graphs, and copying text to and pasting from the Windows Clipboard. Checking or un-checking the View Standard Toolbar command will display or hide the Standard Toolbar. It is normally most convenient to have toolbars visible, but it may be a worthwhile compromise to hide some or all to get more workspace on lower resolution displays such as 640 x 480 pixels. Toolbars may be dragged to another location by clicking and holding the left mouse button on any toolbar area that is not part of an icon. With higher resolution screens, it is normally desirable to drag all toolbars onto the same line rather than having them one above another. Toolbars may also be re-oriented to vertical orientation by dragging them to the left or right margin of the screen, until the outline visible while dragging changes to a vertical box. If a toolbar is pushed completely off screen by dragging another toolbar, the “lost” toolbar may be returned to the screen by first un-checking its name in the View menu, then re-opening the View menu and re-checking the toolbar name.

## Panel Toolbar

---

The Panel Toolbar (shown in chapter 2) contains icons for every instrument panel plus general panels such as Sweep Settling. Checking or un-checking the View Panel Toolbar command will turn the Panel Toolbar on or off. It may be dragged as described above under Standard Toolbar.

Many of the panels are available in both small and large size versions. Simply clicking on an icon causes it to be displayed in the small version. Holding down the  key while clicking on the icon produces a display of the large version (if there are two versions).

## Procedure Toolbar

---

The Procedure Toolbar (illustrated in chapter 2) contains icons for activities including OLE Automation Browser, Run Procedure, Pause Procedure, End Procedure, Toggle Break Points, Quick Watch, Step Into, Step Over, and Step Out. Checking or un-checking the View

Procedure Toolbar command will turn the Procedure Toolbar on or off. It may be dragged as described above under Standard Toolbar.

## Learn Mode Toolbar

The Learn Mode Toolbar (illustrated in chapter 2) contains icons to start or stop Learn Mode. When Learn Mode is activated, operator actions including the result of mouse clicks, menu selections, and text or numeric entries into panel fields, will result in lines of APWIN Basic language code being automatically written into the Procedure Editor. The resulting procedure can then be run to re-create the series of actions. Checking or un-checking the View Learn Mode Toolbar command will turn the Learn Mode Toolbar on or off. It may be dragged as described above under Standard Toolbar.

## Status Bar



Figure 3-1 Status Bar and Page Tabs

The Status Bar at the bottom of the APWIN screen displays at the left short messages about the present activity or the icon under the present mouse cursor location. At the right center, the Status Bar displays the five page tabs. If one or more panels are displayed on a page, the label on the page tab will be in bold characters. Checking or un-checking the View Status Bar command will turn the Status Bar on or off. It is normally most convenient to have the Status Bar visible, but to get more workspace on lower resolution displays such as 640 x 480 pixels, it may be a worthwhile compromise to hide the Status Bar.

## Page 1 through Page 5



The View Page 1 through View Page 5 commands display the specified page of the workspace. They have the same effect as clicking on the Page 1 through Page 5 tabs in the Status Bar or using the

**CTRL** **1** through **CTRL** **5** keystrokes.

## Panels Menu

The System Two Cascade Panels Menu consists of the following commands: Analog Generator (**CTRL** **G**), Digital Generator (**CTRL** **D**), Analog Analyzer (**CTRL** **A**), Digital Analyzer, (**CTRL** **Y**), Sweep (**CTRL** **S**),



Graph, Sweep Settling, DCX, Switcher, Bar Graphs, Data Editor, Digital I/O () , Sync/Ref Input, Status Bits () , Headphone/Speaker () , Procedure Editor, Diagnostic, and Regulation.

Detailed information on the panels may be found in the chapters indicated:

Analog Generator	Analog Generator chapter, page 4-1
Analog Analyzer	Analog Analyzer chapter, page 5-1
Digital Generator	Digital Generator chapter, page 10-1
Digital Analyzer	DSP Audio Analyzer chapter, page 11-1 FFT Spectrum Analyzer chapter, page 14-1 FASTTEST Multitone Analyzer chapter, page 15-1 MLS Quasi-Anechoic Analyzer chapter, page 16-1 INTERVU Interface Analyzer section of Interface chapter, page 8-19 BITTEST Digital Data Analyzer chapter, page 12-1
Sweep	Sweep chapter, page 19-1
Graph and Bar Graphs	Graph and Printing chapter, page 20-1
Sweep Settling	Sweep chapter, page 19-25
DCX	DCX-127 chapter, page 25-1
Switcher	Switchers chapter, page 24-1
Data Editor	Limits chapter, page 21-1
Digital I/O	in Digital Domain chapter, page 7-2; in Digital Interface chapter, page 8-3
Status Bits	Status Bits section of Digital Interface chapter, page 8-46

All panels not listed above are described in this chapter.

## Headphone/Speaker Panel

The System Two Cascade Headphone/Speaker control panel can be brought to the screen by:

clicking on the Headphone/Speaker icon  on the Panels Toolbar

or

selecting Panels Headphone/Speaker from the menu bar

or

from the keyboard, pressing    (for Panels Headphone) or  .

When **Stereo** is selected, different signals are fed to the left and right headphones (in most cases). Both these signals are summed into the internal monaural loudspeaker located in the bottom of the instrument. The possible Stereo selections are Off, Analog Analyzer Reading, Analog Generator, DSP Monitor A&B, Analog Input, DSP Monitor A&C, and DSP Monitor B&D. **Off** disables the audible monitoring function. **Analog Analyzer Reading** connects the final signal of the analog analyzer, following all filtering, to both headphone channels. **Analog Generator** connects the channel A analog generator signal to the left headphone and the channel B analog generator signal to the right headphone. **Analog Input** connects the analog analyzer Channel A input signal to the left headphone and the Channel B signal to the right headphone.

With any of the several **DSP Monitor** selections, the signals audibly monitored depend upon which Digital Analyzer program is in use and whether digital or analog signals are being fed to the DSP. If digital input signals are being monitored with the FFT Spectrum Analyzer (FFT), Digital Interface

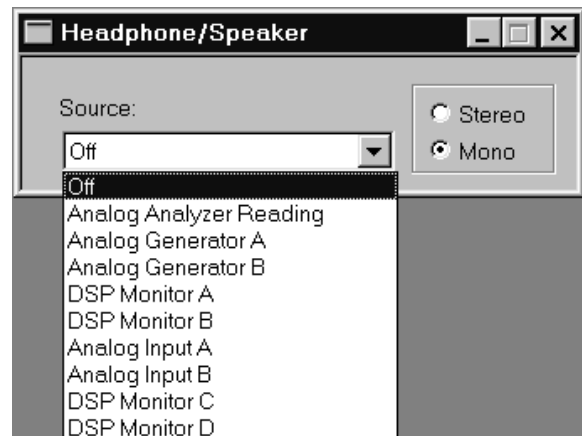

Figure 3-2 Headphone/Speaker Panel

Analyzer (INTERVU), or Multitone Audio Analyzer (FASTTEST), the embedded digital audio signal of Channel A signal drives the left headphone and Channel B drives the right headphone. If analog signals are being measured by FFT or FASTTEST, the signal connected to analyzer Channel 1 drives the left headphone and the analyzer Channel 2 signal drives the right headphone. When the DSP Audio Analyzer program (ANALYZER) is in use, the left headphone monitors the input signal to the main (reading) meter and the right headphone monitors the output signal following all Reading meter filtering. The right headphone would thus be monitoring distortion products after the DSP-implemented notch filter if THD+N measurements were being made on an embedded digital audio signal.

When Mono is selected, a single signal is fed to both left and right headphones and to the internal loudspeaker. The possible Mono selections are Off, Analog Analyzer Reading, Analog Generator A, Analog Generator B, DSP Monitor A, DSP Monitor B, Analog Input A, Analog Input B, DSP Monitor C, and DSP Monitor D. Off disables audible monitoring. Analog Analyzer Reading is the final analog signal in the analog analyzer, following all filtering (and following the wow and flutter discriminator or IMD detectors if the reading meter is in W&F or IMD modes). Analog Generator A and B are the A and B channels of the analog generator. Analog Input A and B are the analog analyzer input signals at channels A and B. DSP A and B depend upon which Digital Analyzer program is in use and whether digital or analog signals are being fed to the DSP. If digital input signals are being monitored with the FFT Spectrum Analyzer (FFT), Digital Interface Analyzer (INTERVU), or Multitone Audio Analyzer (FASTTEST), DSP A is the embedded digital audio signal of Channel A signal and DSP B is the Channel B signal. If analog signals are being measured by FFT or FASTTEST, DSP A is the signal connected to analyzer Channel 1 and DSP B is the analyzer Channel 2 signal. When the DSP Audio Analyzer program (ANALYZER) is in use, DSP C and DSP D monitor the signal following the processing (notch or bandpass filter, highpass, lowpass, and weighting filters) of Function Reading meter channels A and B. For example, these would be the distortion products after the DSP-implemented notch filters of the two channels if THD+N measurements were being made on an embedded digital audio signal.

## Procedure Editor

The Procedure Editor can be brought to the screen by:

clicking on the Procedure Editor icon  on the Panels Toolbar

or

selecting Panels Procedure Editor from the menu bar

or

from the keyboard, pressing    (for Panels Procedure)

or

from the keyboard, pressing    (for pRocedure shOw panel)

Procedure files (.APB file type) are APWIN Basic files which define and control automatic processes. Procedure files can load test files from disk and can also directly control the settings of all instruments. Creation and operation of procedures and details of the APWIN Basic language are covered in the APWIN Basic Programmers Manual and in the Help menu under Help Procedure Language and Help Procedure Topic.

## Diagnostic Panel

The diagnostic panel is used for instrument service, diagnosis and calibration at Audio Precision and Audio Precision authorized Service Centers. It is not intended for use in normal operation.

## Regulation Function

Regulation is a software servo-mechanism which forces a measured parameter to a user-specified target value by automatically adjusting a user-specified setting parameter. Examples include automatically adjusting the generator frequency until measured response is exactly 3.0 dB below the midband reference level or automatically adjusting the generator amplitude until measured distortion at the output of a power amplifier is exactly 1.0%. Regulation can be manually triggered

while viewing instrument panels, or may be automatically invoked at each step of a Source-1 sweep.

Regulation setup and manual triggering of regulation cycles is accomplished with the Regulation panel. This is displayed from the Menu command Panels Regulation.

The Regulation field permits selection of the measurement which will be brought to a target value (regulated) by the function. Clicking the ellipsis (. . .) button at the right of this field displays a browser which may be used to select any measurement parameter of the instrument. The next field to the right (labeled “To”) permits entry of the target value to which the measurement is to be forced. The down arrow at the right of this field allows selections of all available units for the parameter being regulated. The field at the end of this row provides entry capability for the tolerance range around the target value that is deemed acceptable. Tolerance may be set in any of three fashions—%, dB, or Absolute (Abs) as selected by the “radio buttons” above this field. With % selected, the measurement must be within the entered numeric percentage of the target for regulation to be judged complete. For example, with a 1.00 Volt target and a 5% tolerance, regulation is judged complete when the reading falls within the band of 0.95 Volts to 1.05 Volts ( $1.00 \pm 5\%$ ). With the dB mode selected, the reading must be brought within the specified decibel deviation. With a 1.00 Volt target (0.0 dBV) and a 0.5 dB tolerance, successful regulation would be a result between -0.5 dBV and +0.5 dBV (0.944 Volts to 1.059 Volts). With the Abs mode, the target must be within the specified variation from the target in absolute units. For example, if the

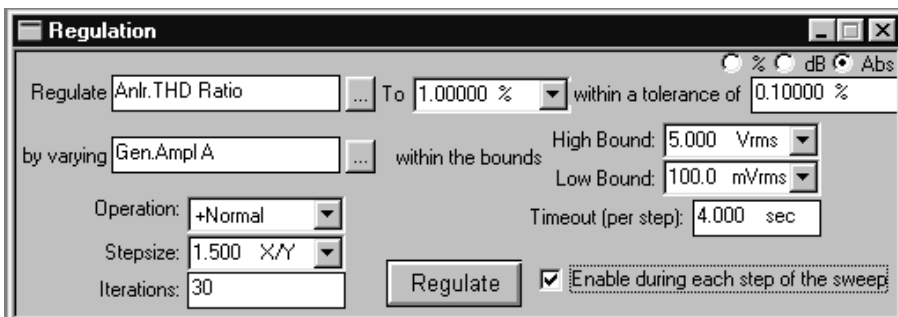

Figure 3-3 Regulation Panel, Typical Setup for Power Bandwidth Sweep

regulated parameter is THD+N in % units and the target is 1.0% THD, an Abs tolerance of 0.5% would cause any measurement between 0.5% and 1.5% ( $1.0\% \pm 0.5\%$ ) to be accepted.

The “by varying” field is for selection of the setting or controlling parameter which will be automatically varied in an effort to reach the target measurement described above. Care must be taken to select a “by varying” parameter which controls or influences the measurement. For example, one would not normally expect to affect the interchannel Phase measurement of a two-channel device by varying the generator amplitude driving that device, but you could expect to affect the distortion of a power amplifier by varying either amplitude or frequency of the generator driving it and may affect the distortion of a D/A converter by varying the amplitude or frequency of injected jitter on the digital output from System Two Cascade. The ellipsis button at the right of the field permits selecting any setting in the instrument. The High Bound and Low Bound fields at the right permit setting upper and lower limits beyond which the Regulation function will not attempt to set the “by varying” parameter. Any available unit for these Bounds fields may be selected via the down arrow at the right.

The “Operation” field selects the mathematical algorithm which relates the “by varying” parameter and the “Regulate” parameter. There are five choices: Linear, +Normal, -Normal, Maximum, and Minimum.

Linear initially assumes that any change in the “by varying” parameter should cause the exact same change in the measured “Regulate” parameter. This is the normal relationship between input and output signal level of an amplifier over its normal operating range. If the initial measured output level from a device is 4.96 dB below the “To” (target) value, the generator amplitude selected in the “by varying” field is increased by 4.96 dB. If this single change in “by varying” value does not bring the “Regulate” value to the target, additional attempts will be made until the target is finally achieved. The “Stepsize” field is gray when Linear is selected, since the actual step change in the “by varying” parameter will be exactly the amount that the measurement of the “Regulate” parameter differs from the target “To” value. The Linear Operation is the fastest and best selection to use when setting device outputs to a reference level or

making frequency response measurements at constant output level or constant modulation percentage.

The “+Normal” selection assumes that the “By varying” parameter and the “Regulate” parameter are proportional, but not necessarily in a linear fashion. This is typical of the relationship between generator amplitude and measured distortion of an amplifier near the maximum power point, or between generator frequency and measured amplitude from a high-pass filter on its attenuation skirt. In “+Normal” operation, the “by varying” parameter starts from its present setting. If the measured “Regulate” value is below the target, the “by varying” parameter is increased by the “Stepsize” amount and the “Regulate” parameter is measured again. When the first increase by the “Stepsize” amount causes the measured “Regulate” parameter to go above the target value, the “by varying” parameter will then be decreased by half the “Stepsize” amount. Each time the “Regulate” parameter measurement crosses through the target, the direction of change of the “by varying” parameter is reversed and the step size is again cut in half. Successful regulation is finally achieved when Regulate is brought within the specified tolerance of the target. The Regulation process will halt earlier if the specified number of “Iterations” is reached.

The “-Normal” algorithm assumes an inverse proportional relationship between “by varying” and “Regulate”. This is typical of the relationship between generator frequency and low-pass filter output amplitude on the attenuation skirt, or between generator amplitude and measured THD+N in relative units (dB or %) in the lower, noise-limited area of operation of a device. “-Normal” works exactly like “+Normal” except that the direction of change of the “by varying” parameter is reversed.

The “Maximum” algorithm controls the “By varying” parameter so as to locate a peak response point. The “by varying” parameter is always started from the present value and is increased in “Stepsize” amounts as long as the “Regulate” parameter is increasing. When the “Regulate” parameter makes a decrease, the direction of change is reversed and the step size is cut in half. The “Maximum” operation continues until the “by varying” parameter has been reversed in direction the number of times entered in the “Iterations” field. The

“Minimum” operation is conceptually similar but expects the “Regulate” parameter to decrease initially and reverses direction each time the “Regulate” parameter goes through a null and starts increasing.

The input information to the Regulation process is a stream of settled readings from an instrument, processed through the Sweep Settling algorithm. If the variability of readings from the instrument is larger than the values set for that parameter on the Sweep Settling panel, the Settling algorithm may not be able to obtain a settled value to pass on to the Regulation algorithm. The Timeout field on the Regulation panel sets a time interval beyond which the Regulation process will not wait for a settled input. Anytime that the Settling algorithm cannot deliver a properly-settled reading to the Regulation process within the Timeout period, the most recent stream of up to 32 unsettled readings from the instrument will be averaged and used as input to Regulation.

A Regulation cycle may be manually triggered by clicking the “Regulate” button on the Regulation panel. If the “Enable during every step of the sweep” checkbox is checked, a Regulation cycle will automatically be triggered at each step, including the Start value, of a Source-1 sweep. The Sweep panel will set the Source 1 parameter to the Start value, a complete Regulation cycle will take place until either success or an exit from Regulation with an Unregulated message, Source 1 steps to the next value, Regulation is triggered again, etc. During a Regulation cycle, whether manually trigger or as part of a sweep, the panel fields displaying the “Regulate” measurement parameter and the “by varying” settings parameter will change to a yellow background.

When making a sweep test with Regulation enabled, it is not typically useful to plot the parameter being regulated, since it will plot as an essentially-flat horizontal line. Plotting the parameter may be desirable during setup to be sure that Regulation is working properly. Here are several examples of Regulated sweeps:

- Using Regulation to hold a power amplifier output distortion constant (perhaps at 1.0%) by varying generator amplitude, but



plotting amplifier output Level in Watts versus generator frequency to produce a graph of power bandwidth.



- Using Regulation to find a minus three dB point on a device, then making a single-point “sweep” to display the measured frequency of that point.
- Using Regulation to hold the modulation percentage (deviation) of a preemphasized broadcast transmitter constant (BNC connector fed from precision demodulator composite or baseband output) while measuring and plotting THD+N versus frequency (XLR connectors fed from de-emphasized outputs of demodulator).
- Using Regulation to hold the modulation percentage (deviation) of a preemphasized broadcast transmitter constant (BNC connector fed from precision demodulator composite or baseband output) while measuring and plotting the generator amplitude vs. frequency required to obtain that constant modulation value. To plot generator amplitude or any other setting value requires checking the “Show Settings” box in the Data 1 through Data 6 browser on the Sweep Panel. This curve is essentially a modulation sensitivity test. Plotting the generator amplitude using normal units will result in a curve that is inverted from the actual preemphasis curve shape of the transmitter. Less generator amplitude is required at high frequencies where the preemphasis curve rises, producing higher modulation sensitivity. Therefore, the dBrInv unit (relative decibels, inverted) may be selected. The dBrInv unit exchanges plus and minus signs to rotate dBr values around the dBr zero value and will produce a preemphasis curve of the expected shape.

## Sweep Menu





The Sweep Menu consists of the following commands: Show Panel, Show Settling Panel, Start (**F9**), Stop (**ESC**), Start with Append (**CTRL F9**), Start with Repeat (**ALT F9**), Transform Data without Acquire (**F6**), Reprocess Data (**CTRL F6**), Compare Data to Limits (**F7**), Copy

Data 1 Settings to Data 2 Settings, Copy Data 2 Settings to Data 1 Settings.



## Show Panel

The Show Panel selection on the Sweep menu causes the Sweep panel to be displayed. This menu command is equivalent to clicking on the Sweep icon , selecting Sweep on the Panels menu, or using the   keystrokes from the keyboard.



## Show Settling Panel

The Show Settling Panel selection causes the Sweep Settling panel to be displayed. This is equivalent to clicking on the Sweep Settling icon , selecting Sweep Settling on the Panels menu, or using the    (for Panels settLing) keystrokes.



## Start

The Start selection on the Sweep menu starts a new sweep test according to the definitions presently set up on the Sweep panel. This menu command is equivalent to pressing the  function key, clicking on the Go button at the bottom of the Sweep panel, or clicking on the icon with the green “light”  on the Standard Toolbar.

## Stop

The Stop selection on the Sweep menu stops any sweep currently in progress. This menu command is equivalent to pressing the  key, clicking on the button at the bottom of the Sweep panel while the button label is “Stop”, or clicking on the icon with the red “light”  on the Standard Toolbar.

## Start with Append





The Start with Append selection on the Sweep menu starts a new sweep test and retains any sweep data already in computer memory. This menu command is equivalent to the   keystroke or to checking the “Append” box on the Sweep panel, then pressing  or clicking on the Go button or green icon. Note that the “Append”

checkbox is not automatically un-checked at the end of a sweep initiated with the Start with Append menu command or the  keystrokes. Future sweeps made with the current setup will continue to be appended to all accumulated sweep data unless the user specifically un-checks the Append checkbox.

Repeating sweeps and appended sweeps may be combined to produce a continuously-repeating sweep that accumulates all the sweep data, by checking both the Append and Repeat checkboxes.

### Start with Repeat

---

The Start with Repeat selection on the Sweep menu starts a new sweep test which will continue with repeated sweeps indefinitely until manually halted with the  key or Stop icon. This menu command is equivalent to the  keystroke or to checking the “Repeat” box on the Sweep panel, then pressing  or clicking on the Go button or green icon. Note that the “Repeat” checkbox is not automatically un-checked when a repeating sweep is interrupted with the  key or Stop button or icon. Future sweeps started by any method ( key, Go button, green light icon, etc.) will repeat continuously unless the user specifically un-checks the Repeat checkbox.

Repeating sweeps and appended sweeps may be combined to produce a continuously-repeating sweep that accumulates all the sweep data, by checking both the Append and Repeat checkboxes.

### Transform Data without Acquire

---

FFT-based (batch mode) DSP programs have three distinct, sequential phases to their operation when the  key is pressed or Go button or green light icon is clicked. First, data is accumulated into the acquisition buffer until the buffer is filled to the specified acquisition length. Second, a Fast Fourier Transform (FFT) is performed to obtain amplitude (and sometimes phase) versus frequency data which is stored in a different memory buffer from the acquired signal (amplitude versus time). Third, a post-processed version of the amplitude versus time or amplitude versus frequency data (depending upon Sweep panel settings at Source 1 and Data 1 or 2) is transmitted from the DSP

module in the test system to the computer for graphing by APWIN software.

It is often desirable to re-transform the data already present in the acquisition buffer, rather than acquiring new data. This will be the case when a previously-acquired waveform is downloaded from computer disk to the DSP module for further analysis. It will also be the case if it is desired to re-transform the existing contents of the acquisition buffer while using a different window function.

The Transform Data without Acquire command on the Sweep menu, or the equivalent  keystrokes, cause the second and third phases described above to take place (FFT transformation and transmission of results to computer). See the FFT functional description in the FFT-Based DSP Programs chapter.

## Reprocess Data

FFT-based (batch mode) DSP programs have three distinct, sequential phases to their operation when the  key is pressed or Go button or green light icon is clicked. First, data is accumulated into the acquisition buffer until the buffer is filled to the specified acquisition length. Second, a Fast Fourier Transform (FFT) is performed to obtain amplitude (and sometimes phase) versus frequency data which is stored in a different memory buffer from the acquired signal (amplitude versus time). Third, a post-processed version of the amplitude versus time or amplitude versus frequency data (depending upon Sweep panel settings at Source 1 and Data 1 or 2) is transmitted from the DSP module in the test system to the computer for graphing by APWIN software.

It is sometimes desirable to perform a new post-processing of the FFT results and transmission of the post-processed data to the computer for display, without acquiring new data and without re-transforming the data already present in the acquisition buffer. This is faster than re-transforming followed by new post-processing. It is automatically done (unless turned off on the General tab of the Utilities Configuration menu) when zooming in on a section of an FFT display and wishing to obtain optimum resolution of the new sub-set of the

original data, or when changing multitone post-processing methods between the normal (response and level), distortion, or noise functions.

The Reprocess command on the Sweep menu, or the equivalent  keystrokes, cause the third phase described above to take place (post-processing of FFT results and transmission of results to computer). See the FFT functional description in the FFT Based DSP Programs chapter.

### Compare Data to Limits

---

The Compare Data to Limits command in the Sweep menu causes any sweep results data presently in computer memory to be re-graphed and compared to limits if limits files (.ADL) are “connected to” the test via the Limits button for each Data variable on the Sweep panel. This menu command is equivalent to the  keystroke.

### Copy Data 1 Settings to Data 2 Settings and Vice-Versa

---

The “Copy Data 1 Settings to Data 2 Settings”, and “Copy Data 2 Settings to Data 1 Settings” assist Sweep panel setup for certain types of two-channel and stereo device testing. If Data 2 is set to None when the “Copy Data 1 Settings to Data 2 Settings” command is selected, an exact copy of every Data 1 field on the Sweep panel is written into the corresponding Data 2 field. If Data 2 has already been selected to an Instrument and Parameter before the command is selected, and if the Data 1 and Data 2 parameters are compatible (both amplitude values or both frequency values, for example), the Data 2 Instrument and Parameter will be left as they were but the Data 1 units, graph top and bottom values, log/lin selection, and divisions settings will all be copied into the corresponding Data 2 fields. If Data 2 has already been selected and the Data 1 and Data 2 parameters are not compatible (dBV at one and Hz or degrees at the other, for example), an error message is displayed and no changes are made. The “Copy Data 2 Settings to Data 1 Settings” works in exactly the same manner but from Data 2 to Data 1.

Note that the Stereo Sweep checkbox at the bottom of the Sweep panel is also an aid in setting up two-channel and stereo device tests, with each technique having its own advantages and disadvantages.

The Stereo Sweep checkbox automatically writes Data 1 settings into Data 3 (and Data 2 settings into Data 4). Data 3 and Data 4 do not have their own selectable units since the graph has only two vertical axes (left and right) for calibration. In the Stereo Sweep mode, Data 3 plots onto the Data 1 axis using Data 1 units.

---

## Compute Menu

The Compute Menu contains a number of powerful mathematical computations that may be applied to the data set in memory following a sweep. The Compute Menu capabilities are described in the Compute chapter.



---

## Procedure Menu

The Procedure Menu consists of the following commands: Show Panel, Open Uses, Learn Mode, Close, Close All, Save All, Run, Pause, End, Step Into, Step Over, Step Out, Step to Cursor, Toggle Breakpoint, Quick Watch, Add Watch, Browse, Set Next Statement, Show Next Statement, and a list of the most recently used Procedures. The functions and operations of these commands is described in detail in the APWIN Basic User's Guide and Programmer's Reference.

---

## Utilities Menu

The following commands make up the Utilities menu: Restore hardware, Hardware status, Configuration, Filters, Turn all outputs off () , Turn outputs back on ( ), Clear log file, View log file, Learn Mode.

---

### Restore Hardware

If APWIN software is started with the measurement instrument not connected to the Audio Precision Interface Bus (APIB), or connected but power not turned on, the Utilities Restore Hardware menu command must be used to set the instrument to the present settings of the software. Utilities Restore Hardware may also sometimes be effectively used as a general reset when the instrument does not appear to be responding normally.

## Hardware Status

The Utilities Hardware Status menu command displays key information about hardware found connected to the Audio Precision Interface Bus (APIB) by APWIN software. This includes the type and address of the interface card and detection of the presence of major instrument modules.

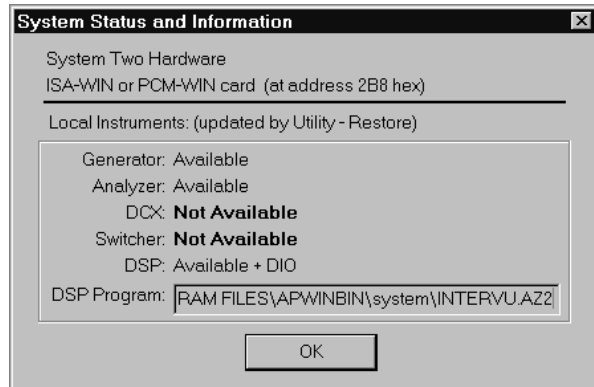

Figure 3-4 Utilities Hardware Status Information

## Utilities Configuration

The Utilities Configuration command permits custom-tailoring of a number of APWIN functions to the user's preference, described in the following sections. When any changes have been made to the Utilities Configuration dialog box, click the OK button if you wish the changes to become effective. Click the Cancel button if you do not wish the changes to take effect. The Utilities Configuration dialog is organized into five tabs—General, Hardware, Configure Filters, Log, and Graph.

### General Tab

The General tab provides control of the following features.

### Prompt to Save Test

When the “Prompt to Save Test when a test is closed” checkbox on the Utilities Configuration dialog is checked, APWIN will prompt the user to save the test currently in memory whenever an action is initiated which would destroy the test in memory. Examples of actions which destroy the test in memory include clicking on the new test icon



or selecting the File Open Test or Open Data or File New Test

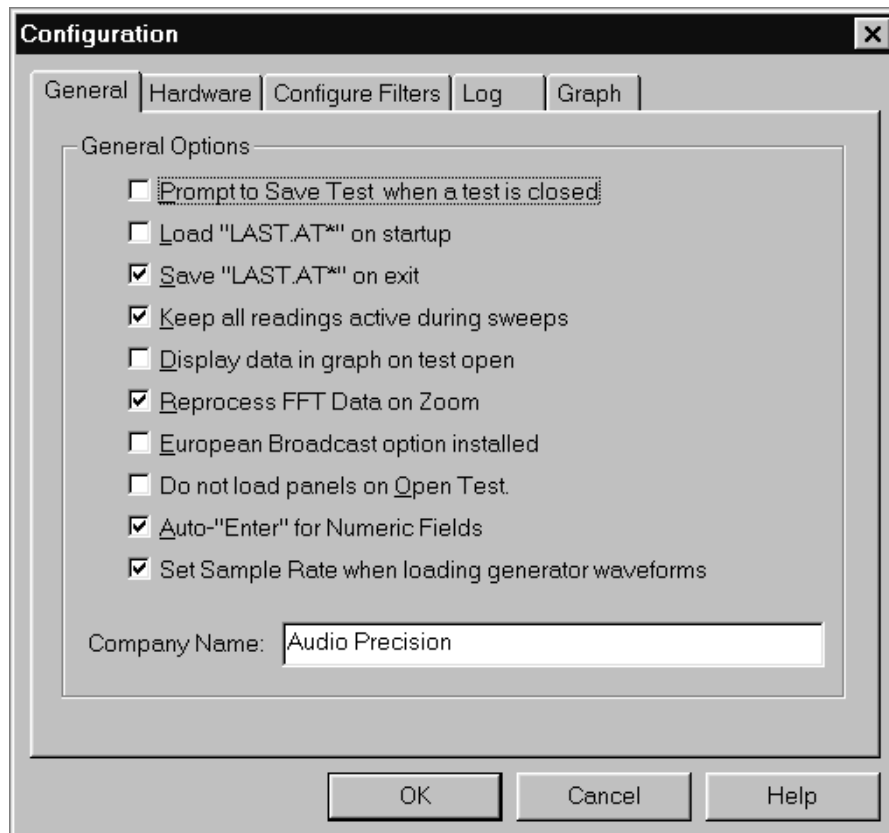

Figure 3-5 Utilities Configuration Dialog Box

menu commands. If the box is not checked, no reminder is given that the test presently in memory will be replaced by the action initiated.

### Last test save and load

The Utilities Configuration dialog box contains two check boxes to manage LAST.AT1 or LAST.AT2 activities.

**Load LAST.AT1 or LAST.AT2 on startup:** when this box is checked, APWIN will automatically load a test named LAST.AT2C located in the “home” directory. The “home” directory is the directory specified by the user or is automatically selected as C:\APWIN by the installation procedure when APWIN is initially installed.



**Save LAST.AT1 or LAST.AT2 on exit:** when this box is checked, APWIN automatically saves as LAST.AT2C, in the home directory, the test in memory at the time that APWIN is closed.



### Readings active during sweeps

When the “Keep all readings active during sweeps” checkbox on the Utilities Configuration dialog is checked, all meters on all panels will actively update their readings even during sweeps. If this box is not checked, only the meters whose measurements are selected for plotting at Data 1 through 6 or Source 1 through 2 will be active during a sweep, with all other meters “frozen” during the sweep. Keeping the readings active during a sweep permits other parameters to be observed while a sweep is in progress, but it will slow down the sweep itself since the computer processor must service those additional meters.

### Graph Data When Test Opened

When the “Display data in graph on test open” box is checked, any data stored with a test will be automatically graphed (and compared to limits, if any) when the test is opened. If the box is not checked, data loads into data memory but will not be graphed until the  key is pressed or the Sweep Compare Data to Limits menu command is issued.

### Re-Process FFT Data on Zoom

When this box is checked, each graph zoom in action (by dragging the mouse) or Zoomout or Zoomout to Original action (right mouse button menu on graph) will be accompanied by a “Sweep Re-Process Data” ( ) command. If the acquired signal is still in DSP memory, this assures that the resolution is always the maximum supported by either the number of points graphed or the FFT transform length. See the FFT functional description in the FFT Based DSP Programs chapter.

## European Broadcast Option Installed

A hardware option is available for System Two Cascade which changes output termination (source) resistance values in the analog generator. The European option analog generator balanced output impedances are 40, 200, or 600 Ohms instead of the standard 40, 150, or 600 Ohms. In order for APWIN software to properly show these selections on the panel and use the correct generator source value in calculating output power with generator dBm and Watts units, the “European Broadcast Option Installed” checkbox must be checked. Do not check this box if the hardware option has not been installed.

## Do Not Load Panels On Open Test

When this box is not checked and a test file is loaded from disk, all instrument panels, bargraphs, and graphs are loaded on each page at the location and size that they were when the test was saved. If this box is checked, loading a test will load all the instrument control settings (waveform, amplitude, frequency, analysis function, etc.), sweep settings, etc., but will leave panels and graphs as they were immediately before test loading.

## Numeric Field Auto Enter

The Auto “Enter” for Numeric Fields checkbox controls the style of operation on the many numeric data entry fields such as generator Amplitude or Sweep Panel Source 1 Start Frequency. When Auto “Enter” for Numeric Fields is not checked, APWIN operates in its original style that requires the user to follow a numeric entry by pressing the Enter or Tab keys before the entry will take effect. If Auto “Enter” for Numeric Fields is checked, a number can be typed into a field and will automatically take effect when the cursor leaves the field, such as by clicking on another field.

## Set Sample Rate When Loading Generator Waveforms

Arbitrary waveforms (.AGM or .AGS file types), usually multitones, may be loaded into the analog or digital generators. Most applications for such waveforms require that they be generated with the exact

sample rate for which they were created by MAKEWAV3 and the Utilities Create Multitone menu command. Each .AGM or .AGS file contains information on the design value of sample rate. If the “Set Sample Rate . . .” box is checked, APWIN will automatically set the correct sample rate to correspond to that encoded in the generator file. If the box is not checked, the user is responsible for setting the desired rate. Setting the correct sample rate may involve changing the selection in the D/A Sample Rate field on the Analog Generator panel between 65536, 131072, or OSR and, if OSR is the selection, may also involve changing the value of OSR (Output Sample Rate) on the DIO panel.

### Company Name

The Company Name box permits entry of a name (or other information) up to 32 characters that will appear in the Title Bar of the Graph. The default Company Name is Audio Precision, but it may be replaced with text of the user’s choice. Note that even though a Company Name is in use, the user has the choice via the Title and Labels dialog box of whether it displays on screen in the Graph Title Bar. The Titles and Tables dialog is obtained by a right mouse click on the graph. The user has control via the Page Setup screen of whether the Company Name prints as part of a graph hard copy.

### Hardware Tab

The Hardware tab carries the choices of hardware platform (System One versus System Two vs System Two Cascade) that APWIN should assume when it is started. One and only one of these “radio buttons” may be selected.

If **System One** is selected, APWIN will always configure itself for System One hardware when started. It will not operate properly with System Two or Cascade instruments.

If **System Two** is selected, APWIN configures itself for System Two hardware when started. It will not operate properly with System One or Cascade instruments.

If **System Two Cascade** is selected, APWIN configures itself for Cascade hardware. It will not operate properly with System One or standard System Two instruments.

If **System Two Cascade Operating in System Two Compatibility Mode** is selected, APWIN will operate properly only with a Cascade instrument connected. However, all features of Cascade that are not also present in standard System Two are disabled. Thus, tests can be set up and verified on a Cascade instrument and saved with assurance that they will operate identically on a standard System Two instrument.

If **Prompt for Choice** is selected, APWIN will display a dialog box at start-up and wait for the user to select the desired instrument button.

If **Auto Select** is selected, APWIN looks for coding unique to System Two and System Two Cascade modules and configures itself accordingly if they are found, otherwise configures itself for System One. The System One or System Two instrument must have power applied at the time APWIN is started for this selection to be effective; if no instrument is detected (which can be due to power not being applied), the “Prompt for Choice” dialog will be displayed. If the incorrect instrument is manually selected, you must quit APWIN and re-start the software.

## Configure Filters

The Configure Filters tab is an alternate route to the same analog analyzer plug-in option filter setup utility that can also be viewed by the Utilities Filters menu command described below. Both operate identically.

## Log Tab

The Log tab carries all the instructions for logging files.

## Log Files

The Log File (.ALG file type) can serve as a record of many important APWIN operations such as limits failures, test names, date

and time each test ran, file loading and saving activity, and error messages. The Log File can be viewed on screen or printed to paper.

Unless manually cleared by the Utilities Clear Log File menu command, all new information (of the categories defined by the user) is added to the bottom of the Log File so that it becomes a growing record of the specified activities of the software. Thus, a Log File can become a complete record of an entire audio testing procedure.

### Establishing the Log File Name

Type the name to be created for a Log File into the Filename box. The .ALG extension will be automatically furnished. If no information other than the file name is furnished, the log file will be saved in the “Log” subdirectory under the “Home” directory. With the default installation procedure, the log file will thus be saved into the C:\APWIN\LOG directory. If the user supplies an explicit path with the log file name, it will be saved into the specific directory specified. If the user types “.\filename”, the log file will be saved into the Current Working Directory. See the discussion of Current Working Directory in the File Menus section on page 3-10.

### Turning Logging On and Off

The “Log Errors” checkbox controls whether logging actually takes place. With the box checked, information of the types specified by the checkboxes and radio buttons below will be logged into the file name established. If the box is un-checked, no logging takes place.

### Information to Include in Log File

The Log File can contain a number of different types of information, at the user’s option. The selectable information types include:

**Error messages:** when this box is checked, any APWIN or Windows error messages which occur during the period that logging is turned on will be written into the Log File.

**File I/O Activity:** when this box is checked, a text message will be written into the Log File for every disk file opened or every file saved

to disk. The message includes the name and full path name of the file and the date and time at which it was opened or saved.

The Log Sweep Activity section permits inclusion or exclusion from the Log File of several pieces of information relating to the running of tests. The selections are:

**Test Name:** the name, including path name, of the test that was executed

**Graph Title, Time and Date:** the Graph Title and Time and Date at which the test was executed, exactly as they are displayed in the title bar of the graph.

**Pass/Fail Message:** when this box is checked, an error summary message will be written into the Log File each time a test is run. The first word of the message will be PASSED or FAILED. Following a colon (:), the error message will include the number of measurements which were below the lower limit, the number of measurements which were above the upper limit, and the number of Timeouts which occurred. If the box is not checked, no error summary message is written into the file.

**Log Sweep Data; None, All, Failed Only:** these three radio buttons permit control of whether no test point values (None), all test point values (All), or only those test points which were outside limits (Failed Only) are written into the Log File. Any values written into the Log File which were outside limits will have parenthesis at the end with the (less than) or (greater than) symbol and the value of the limit which they failed.

### Example Log File

The Log File is an ASCII file that can be viewed in or printed from almost any text editor, such as Windows Notepad. An example is shown:

```

C:\Program Files\APWIN\SAMPLES\sample.at1
Sample Response Test w/Limits 07/09/95 11:10:13
FAILED : Lower Limit 3, Upper Limit 4, Timeouts 0
Gen.Freq(Hz)      Anlr.Level A(dBr)
20000             5.000000(>2)
10022.5           4.200000(>2)
5025              2.100000(>1)
2517.5           1.800000(>1)
79.625           -1.800000(<.5)
39.9             -2.100000(<.5)
20               -2.700000(<.5)

```

The first line is the test file name and path. The second line is the Graph Title, date, and time. The third line is the “Pass/Fail Message” which summarizes failures. The “Failed Only” option was in use, so the remaining lines consist of the points which were outside limits. The points below 2517.5 Hz and above 79.625 Hz were within limits and thus are not shown. The “greater than” (<) and “less than” (>) symbols and numbers at the end of each row show where the value was above the upper limit or below the lower limit, and the value of the limit itself.

### Graph Tab

The Graph tab provides control over several modes of trace color selection and over whether the “Edit Copy Panel to Clipboard” copies a black-background bitmap or a white-background metafile graph to the Windows clipboard.

### Copy To Clipboard

APWIN can copy the graph (if the graph has the Windows focus) to the Windows clipboard as a bitmap image or metafile. From the clipboard, the graph can then be pasted into almost any Windows program supporting graphics. The bitmap, as an exact pixel-for-pixel copy of the graph on screen, has a black background. It is also possible to copy a white-background metafile to the clipboard and then paste it into another application. A metafile is a vector rendition of the graph. It will print at the resolution of the output device,

unrelated to the graph size, shape, and resolution on screen at the time of capture.

The Graph tab of the Utilities Configuration dialog controls which type of copy will be made. Under “Copy to Clipboard, Background Color”, click the Black “As Bitmap” button for a black-background bitmap to be copied to the clipboard. Click the White “As Metafile” button for a white-background Windows Metafile. The text content of the metafile, colors, trace line styles, etc. are determined by the File Page Setup dialog. This permits the Title, Legend, Comments, etc. to be individually turned on and off. The margins, centering, and Fill Page controls of Page Setup have no effect on the metafile.

### Graph Trace Color

Controls on the Graph tab provide functions on how colors are assigned to traces on the graph. Six colors (plus gray) are available for graph trace colors. There is a defined sequence of these six trace colors: cyan, green, yellow, red, magenta, and blue. This is the order in which the colors appear in the drop-down list in the Color column of the Graph Legend

### Nested and Appended Sweeps

When appended or nested sweeps are made, each trace cycles down through this color sequence, starting with whatever color the trace was on the previous sweep. An appended or nested sweep following a green trace thus always produces yellow, appending to a red trace always produces magenta, appending to a blue trace always goes “around the corner” to cyan, etc.

### Reset Colors Cycle Checkbox

If the “Reset colors cycle” box is checked and a normal sweep is made (not appended or nested), each trace color is directly associated with the Sweep panel Data parameter number that produces the trace. The color of the Data-1 trace is always cyan, the Data-2 trace is always green, Data-3 is always yellow, Data-4 is always red, Data-5 is always magenta, and Data-6 is always blue. If the user should manually change the color of any trace to another color following a sweep, then



makes another sweep, the trace color will revert to the defined color per this paragraph. Appending and nesting sweeps will cause each trace color to cycle down through the sequence defined at the beginning of this section.

If the “Reset colors cycle” box is not checked, the user can manually change trace colors using the Legend and those user-selected colors will then be used for each successive normal (not appended or nested) sweep. These user-selected colors will also serve as the starting point for the automatic color cycling of appended or nested sweeps, with the cycling for any trace always being in the defined sequence described above. This mode of operation can allow three dual-trace sweeps or two triple-trace sweeps to be made with no duplication of colors. For example, a sweep is made using Data 1 and Data 2. The default colors assigned will be cyan for Data 1 and green for Data 2. If the “Reset colors cycle” box is not checked, the green Data 2 trace can be manually changed to red (the fourth color in the sequence). Now three sweeps can be made via Append or nested sweep. Colors for the first sweep will be cyan and red (1st and 4th colors), for the second sweep green and magenta (2nd and 5th colors), and for the third sweep yellow and blue (3rd and 6th colors), as each trace progresses through the color sequence list.

### Use Test Colors Only Checkbox

If a test is loaded, the Append box checked, and additional sweeps are made (F9 or Go), the colors of the newly measured and appended traces depend on the “Use test colors only” box. If this box is checked, each newly appended set of traces will be the same color as the traces in the test that was loaded. If this box is not checked, the newly appended trace colors will cycle through the defined sequence, starting with the color of each trace in the test loaded.

### Cycle Trace Colors Checkbox

When the File Append command is used, the color of the appended traces depends on the status of the “Cycle trace colors” box. If this box is not checked, the trace colors of the appended file will come in exactly as they were in the file on disk being appended. If this box is checked, the colors of the traces appended from disk file will

cycle through the defined sequence, using as the starting point the last set of traces currently in memory.

## Utilities Filters

The Utilities Filters menu command permits the System Two Cascade user to use automatic detection of the type of plug-in option filter plugged into each of the seven sockets (slots). Automatic detection requires filters of recent manufacture (filter circuit board copyright date 1995 or later). To trigger the automatic detection of filters and automatic writing of those filter types into the Analog Analyzer Filter selection list, click on the Utilities Filter command. On the Configure Filters dialog which is displayed, verify that the Auto Detect checkbox is checked for all slots which contain filters of 1995 or later date. The filters which are found in each slot will be displayed, but gray, in the Name column. Then, click on the OK button to cause those selections to write to the analyzer panel.

If older filters are used, they must be manually identified as being in a specific slot. Once the filter-to-slot relationship has been defined, filters may be selected by name rather than only by slot number in the Filters list box on the Analog Analyzer panel. To manually identify a filter after plugging it into any of the slots, un-check the Auto Detect

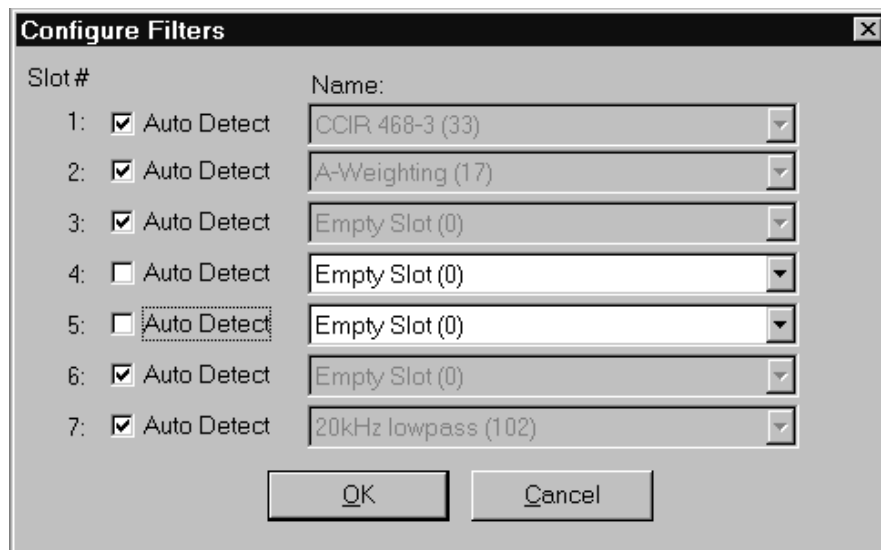







Figure 3-6 Utilities Filters Dialog Box

box corresponding to that slot. Designate the filter name by clicking on the down arrow at the right end of the box to display a list of names. Use the scroll bars if necessary to locate the particular filter type, and click on the filter name (or use up and down arrows and the  key). Click on the OK button to write the selections to the analyzer panel.



## Turn All Outputs Off

---

The Utilities Turn All Outputs Off command, or the  function key, turns off the outputs of all analog and digital generators. It is thus equivalent to the  function key of the earlier S1.EXE DOS software. The intent of this function is for a “panic button” or emergency button if it is determined that the device under test is potentially being damaged or people are being disturbed by the application of signal. All outputs which are turned off by this command may be turned back on by the Utilities Turn Outputs Back On command or the   function key.

## Turn Outputs Back On

---

This menu command and the   keystroke alternative serves as the “restore” for the Utilities Turn All Outputs Off command. It will turn back on all outputs which were turned off by an  function key operation or the Utilities Turn All Outputs Off command, but will not turn on any outputs which were not on when that command was issued.

## Clear Log File

---

The Utilities Clear Log File command erases all contents from the log file. It does not change any selections for what will be written into the new log file when the next test is run.

## View Log File

---

The Utilities View Log File launches the Windows Notepad editor with the Log File loaded. Windows Notepad then supports printing the Log File, saving it to another directory or under another name, etc.

## Multitone Creation

---

The Utilities Multitone Creation command starts an interactive process for the creation of multitone waveforms for use with FASTTEST analysis. See the section on creating multitone waveforms on page 15-26 for a complete description on use of this utility.

## Window Menu

---

The Window Menu consists of these commands: Tile, Arrange Icons, Close All.

### Tile

---

The Windows Tile command arranges all open panels (windows) on the current page to be visible and non-overlapping if possible. If there is insufficient open space, the Tile command may place windows on top of other windows.

### Arrange Icons

---

The Window Arrange Icons command organizes all minimized panel icons at the bottom of the workspace so that they are visible.

Panels may be minimized by clicking on the  icon near the upper right corner of a panel or window.

### Close All





---

The Windows Close All command closes all windows (panels) on the current page. It is thus equivalent to clicking on the  icon at the upper right of each individual panel on the current page. Closed panels still exercise the same control settings over the hardware or software functions that they did when visible.

## Help Menu

---

The Help Menu consists of the following topics: Index, Using Help, APWIN Basic Language, APWIN Basic Extensions, APWIN Basic Editor, About APWIN, Release Notes.

Context-sensitive Help is implemented for most panel fields of APWIN. Select the panel control you desire information on, using the mouse cursor or  and  keys, and press . If context-sensitive Help is not available for a specific panel control selected, the Contents topic of Help will be displayed when the  key is pressed.

## Index

---

The Help Index command launches the Windows Help Viewer with the APWIN Help file loaded. The Contents section, equivalent to a Table of Contents in a printed book, will be initially displayed. The user can click on the green underlined text of a listed topic to jump directly to that topic. Alternately, the Search button may be clicked to bring up a key word location feature similar to the index in a printed book.

## Using Help

---

The Help Using Help command launches the Windows Help Viewer with the Help file loaded that describes how to use the Windows Help feature. It describes how to navigate among Help topics, how to annotate Help topics with your own personal notes, how to create “bookmarks” to make it easy to find frequently-used topics, how to copy a Help topic to the Windows clipboard or to print a Help topic, how to display the history of your navigation through Help topics, and provides specific information on each command of the Help Viewer. Under Windows 95, the Help on Help explains how to use new features such as changing font size and performing searches for individual words or phrases.

## APWIN Basic Language

---

The APWIN Basic Language is compatible with Microsoft Visual Basic for Applications. It is a full-featured programming language with special features for creation of user dialogs containing various controls. Basic Language Help describes the general programming features of this language. See the separate APWIN Basic User’s Guide and Programmers Reference.

---

## APWIN Basic Extensions

---

A large number of Audio Precision specific extensions have been added to the general programming features of the language. These extensions provide complete control over every stimulus and measurement function, sweeps, graphs, etc. Basic Extensions Help describes these specific additions for the instrument. See the separate APWIN Basic User's Guide and Programmers Reference.

---

## APWIN Basic Editor

---

The APWIN Basic Editor (Procedure Editor) is provided to create and modify procedures. Features of this editor are described in Basic Editor Help. See the separate APWIN Basic User's Guide and Programmers Reference.

---

## About APWIN

---

The Help About APWIN menu command displays information on the version numbers of key elements of APWIN software. This information may be requested by Audio Precision Applications Engineers if you call for technical support.

---

## Release Notes

---

The Help Release Notes menu command launches the Windows Notepad editor with the APREADME.TXT file loaded. This file contains last-minute information on the particular software release and may include information not present in the User's Manual or on-line Help.



# Analog Generator

## Analog Generator Panel

To bring the Analog Generator panel to the screen:

Mouse: Click on the Analog Generator icon  on the toolbar or select Panels Analog Generator via the menu bar

Keyboard: Type  or  (for Panels analog Generator).

The normal default start-up mode of APWIN software has the Analog Generator panel on page one.

The System Two Cascade Analog Generator panel may be displayed in two sizes. The smaller version (displayed at start-up) shows only the most important controls—waveform selection, frequency, secondary parameters for certain waveforms, the channel select and invert controls, output on/mute button, and amplitude controls. The larger version shows these same controls plus output configuration controls (impedance, balanced-unbalanced, common mode test mode) and reference values for the dBm, Watts, dBr, and relative frequency units. Clicking on the panel icon on the Panels Toolbar brings up the small version panel.

Holding down the  key while clicking on the toolbar icon brings up the large version. To switch between the small and large panels:

Mouse:  
Double-click anywhere in the title bar, or click

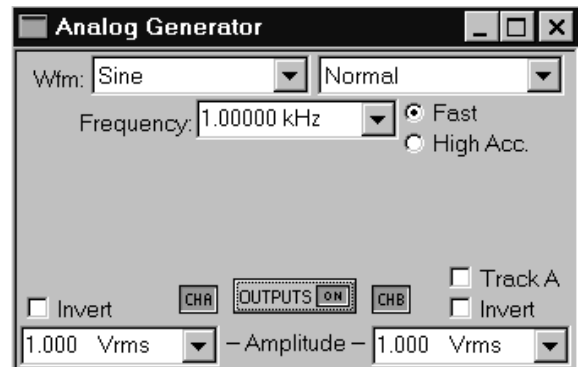

Figure 4-1 System Two Analog Generator Control Panel, Small Version



on the middle of the three icons at the top right of the panel



, in the control bar.

Keyboard: Press the or keys.

## Waveform Selection

The waveform field settings determines the type of signal waveform which will be generated. The two waveform fields permit selection of the general category (Sine, IMD, etc.) in the left-hand field, followed by selection of the specific waveform within that category in the right-hand field. Availability of waveforms other than sine and EQ sine requires that specific hardware modules be present. These include analog-generated IMD (Intermodulation Distortion) test waveforms (require IMD generator option), burst-triggered-gated sine, squarewaves, and white-pink-selective random or pseudorandom noise waveforms (require BUR option), and all D/A-generated waveforms (require DSP module). To change waveforms:

Mouse: Click on the down arrow at the right of the box to display a list of available waveforms. Click on the name of the desired waveform to select it.

Keyboard: Shift the focus to the Analog Generator panel, if necessary, with the keys. Select the Waveform field with the key (moves selection downwards) or keys (moves selection upwards). Press the key to display the list. Use the

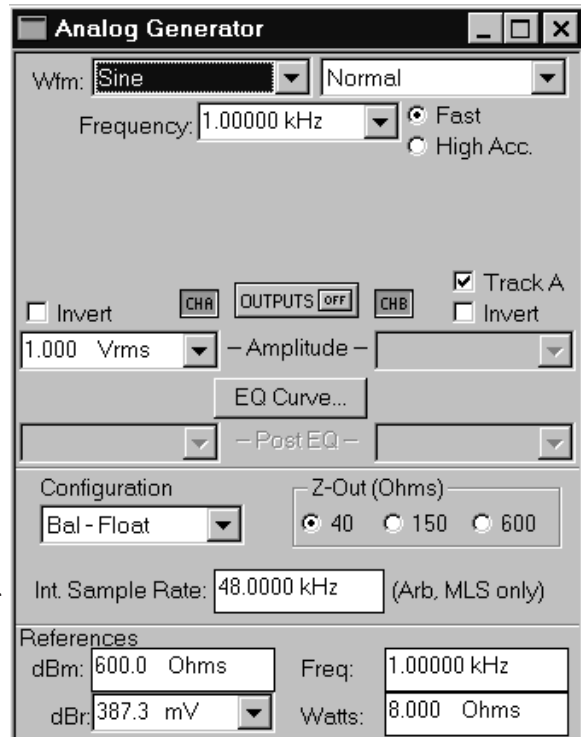
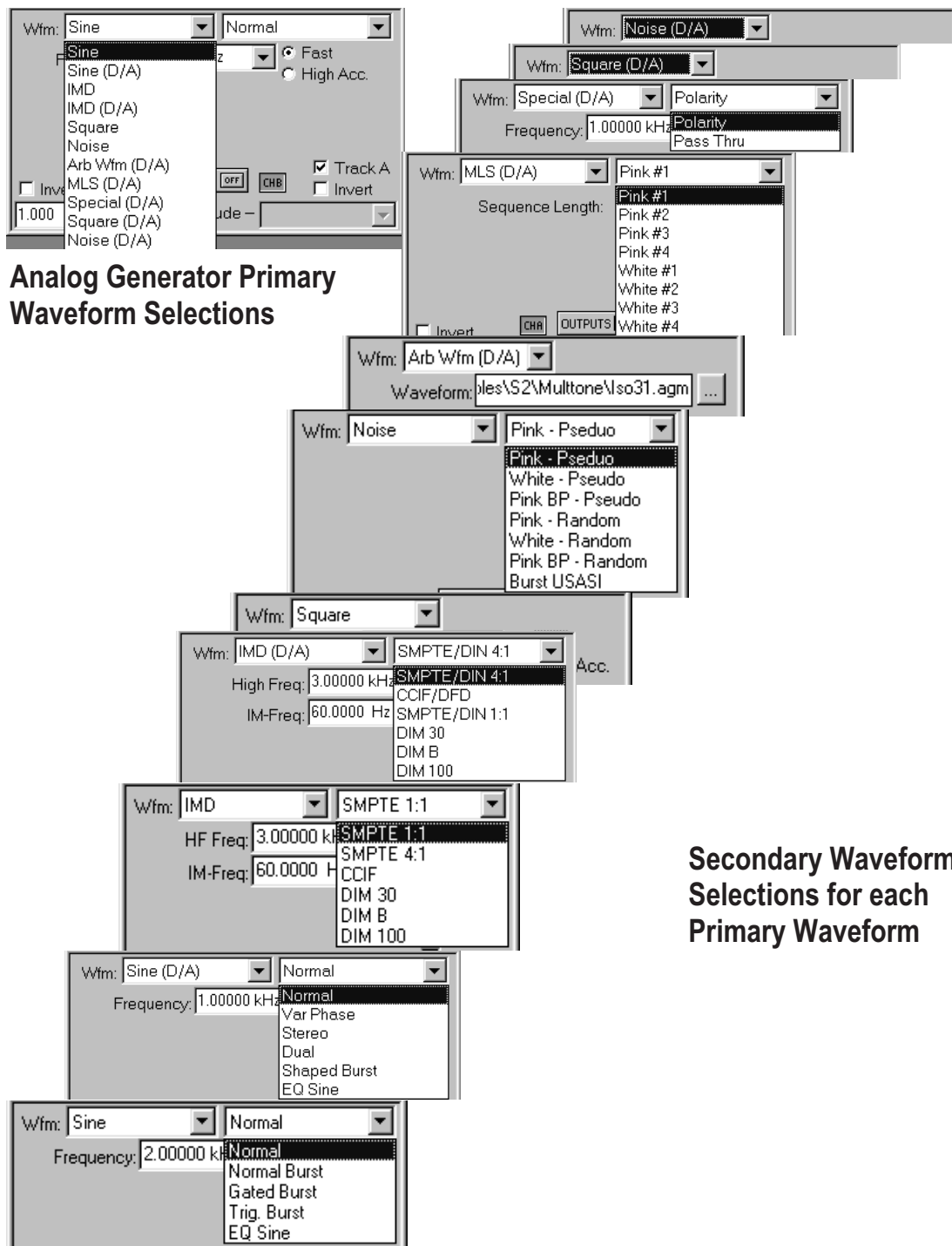





Figure 4-2 Analog Generator Panel, Large Version



**Analog Generator Primary Waveform Selections**

**Secondary Waveform Selections for each Primary Waveform**

Figure 4-3 Analog Generator Waveform Selection

  keys to move the waveform selection indication up or down the list. When the desired waveform is selected, press .

Secondary fields then permit selections of various forms of the waveform. Figure 4-3 shows the primary analog generator waveform field selections and the secondary selections for each primary waveform. The waveforms are briefly described below.

With a System Two Cascade (SYS-2422 or SYS-2522 models), many DSP-generated waveforms (all those with “D/A” in the first Waveform field) may be routed through stereo D/A converters to the analog generator output stage. With one exception, these DSP-generated waveforms fed through the analog output are completely independent from DSP-generated waveforms fed to the digital output. For example, Sine (D/A) Stereo may be selected on the analog generator while IMD is selected on the digital generator, with the analog and digital output signals completely independent of one another. The single exception is the Arbitrary Waveform “Arb Wfm (D/A)”. Only one pair of stereo generator waveform memory locations is available, so if an arbitrary waveform is being generated at both analog and digital outputs, it must be from the same waveform file.

For all “D/A” waveforms except Arbitrary Waveforms and MLS signals, the DSP generator and D/A converters operate at one of two fixed sample rates selected by the D/A Bandwidth field in the lower section of the large form of the panel. Selecting the “30k” choice uses the D/A converters at their sample rate of highest performance to minimize residual distortion and noise, but the upper frequency limit is 30 kHz. The “60k” choice permits operation to higher frequencies at some cost in residual distortion and noise. For Arbitrary Waveforms and MLS signals, it is critical that generator and analyzer sample rates exactly match. The “D/A Sample Rate” field near the bottom of the large form of the Analog Generator panel controls the generator and D/A sample rate when either of these waveforms is generated. The four available selections are 65536 (Hz), 131072 (Hz), OSR, and ISR.

The “65536” selection is the identical rate to the “A/D @65536” selections on the several DSP analyzer programs. The “131072” selection is identical to the “A/D @131072” selections on the analyzers. The reason for the 65,536 and 131,072 Hz sample rate

selections is to produce generator frequency resolution values and analyzer FFT bin width values that are exact even integer numbers of Hz. For example, with the FFT analyzer FFT length of 32,768 samples and a 65,536 Hz sample rate, the resulting FFT bin widths are exactly 2.00 Hz.

OSR is the digital Output Sample Rate, settable on the DIO panel. This selection is used when it is desired to have analog domain and digital domain multitone signals generated at exactly the same sample rate, or when some arbitrary sample rate is desired for analog domain signals. ISR is the digital input signal sample rate, measured and displayed on the DIO panel. This selection is typically used when testing A/D converters, in order to produce multitone signals synchronous with the converter sample rate.

## Sine Waveforms

---

The secondary selections available with Sine waveform are Normal, Normal Burst, Gated Burst, Trig. Burst, and EQ Sine.

### Sine Normal

The Sine Normal waveform is the standard waveform produced by the low-distortion analog hardware generator. Frequency coverage is from 10 Hz to approximately 204 kHz.

### Sine Burst Waveforms Overview

The tone burst capability of the BUR-GEN module provides sinewave bursts which switch between normal, calibrated generator sinewave amplitude and a lower amplitude. Switching between the higher and lower levels always occurs at a positive-going zero crossing, thus there will always be an integer number of complete cycles in the burst. The duration and repetition rate of the burst are controllable, as is the lower amplitude. The sinewave is produced by the main sinewave oscillator. Thus, its frequency and the higher amplitude are determined by the normal frequency and amplitude settings on the analog generator panel. In addition to the free-running, repetitive mode of Burst Normal waveform, bursts may be either externally triggered (Burst Triggered) or the signal may be gated on and off (Burst

Gated) by an external signal. The tone burst parameters may be swept.

### Burst Control

The burst control area of the Analog Generator panel consists of up to three additional fields labeled Burst On, Interval, and Low Level. All three of these fields will be visible only when Sine

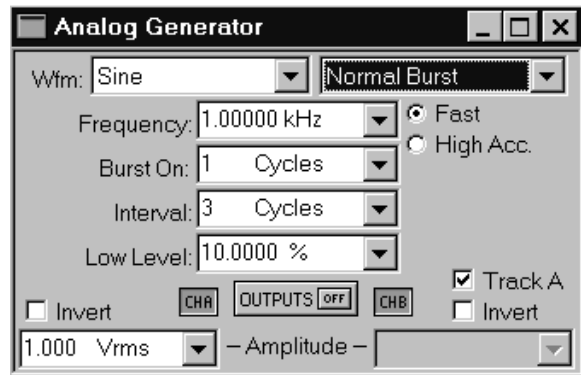

Figure 4-4 Tone Burst Control Fields

Normal Burst mode is selected in the Waveform fields. Only the Burst On and Low Level lines will be displayed when Sine Trig Burst waveform is selected, and only the Low Level line will be displayed when Sine Burst Gated waveform is selected.

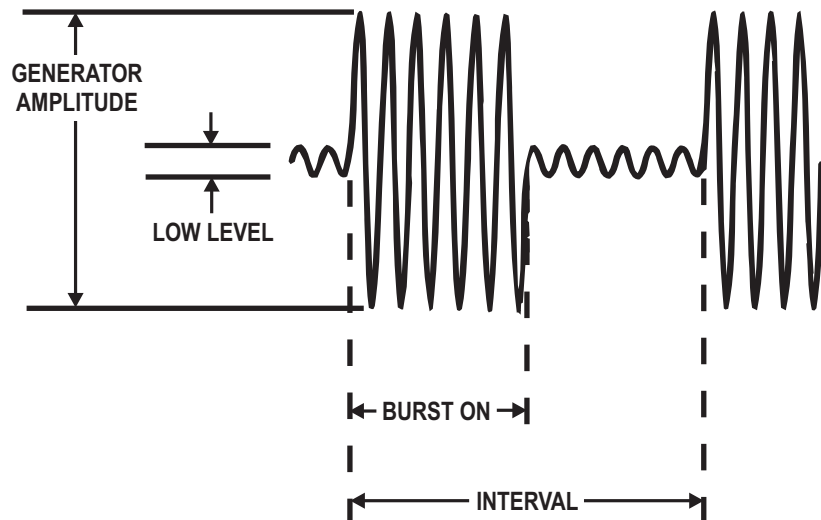

Figure 4-5 Tone Burst Definitions, Burst Normal Waveform

## Burst On (Duration)

The maximum Burst length is 65,535 cycles of sinewave. The burst “on” time may be set in cycles.

## Burst Interval

Interval is the time from the beginning of one burst to the beginning of the next burst, not the time between the end of one burst and the beginning of the next. The maximum burst Interval is 65,536 cycles of sinewave.

## Low Level

The amplitude of signal between bursts is controlled by the **Low Level** parameter. The Low Level value is relative to the Burst “on” level, which is the calibrated steady-state level controlled by the Amplitude field. The Low Level (low level) line controls the amplitude of the generator output between bursts. In triggered and gated mode, the generator output will be at the Low Level amplitude between triggered bursts or gated-on portions. The Low Level amplitude may be set in any of four units.

**%** lower level expressed as a percentage of calibrated level

**dB** lower level in decibels relative to calibrated level

**X/Y** ratio of lower level (X) to calibrated level (Y)

**PPM** lower level in Parts Per Million of calibrated level value

The lower level amplitude may equal the upper level amplitude, in which case no burst, gated, or triggered effect will be visible. At large amplitude ratios, the amplitude resolution of the lower level becomes poorer. The display will show the actual available resolution steps, rather than the entered value. The lower level is limited to -80 dB (0.01%).

The Interval line is blanked in Burst Triggered waveform, since the burst interval will be determined by the external trigger source.

Both the Burst (duration) and the Interval lines are blanked in Burst Gated waveform, since both these parameters are determined by the external gating signal.

### Triggered Bursts

In triggered operation (Burst Triggered waveform mode), one burst of the specified Burst duration will be generated for each trigger presented to the TRIG/GATE input. This input is a BNC connector in the GENERATOR AUX SIGNALS section of the lower right front panel. The input is LSTTL compatible. In Burst Triggered mode, it is intended to be driven by a signal that is at a logic high level but pulses low for at least one microsecond to trigger a burst. The figure shows the relationships between the trigger signal and the generator output for an example burst of four cycles. The burst will be triggered by the positive-going (trailing) edge of such a signal. The burst will begin at the first positive-going zero crossing of the sinewave signal which follows the positive-going edge of the trigger signal. The burst will begin at the first positive-going zero crossing of the sinewave signal which follows the positive-going edge of the trigger signal. If the TRIG/GATE input signal remains at the logic high level after triggering the burst and between bursts, the burst duration will be as set on the panel and the generator output amplitude will remain at the Low Level value until

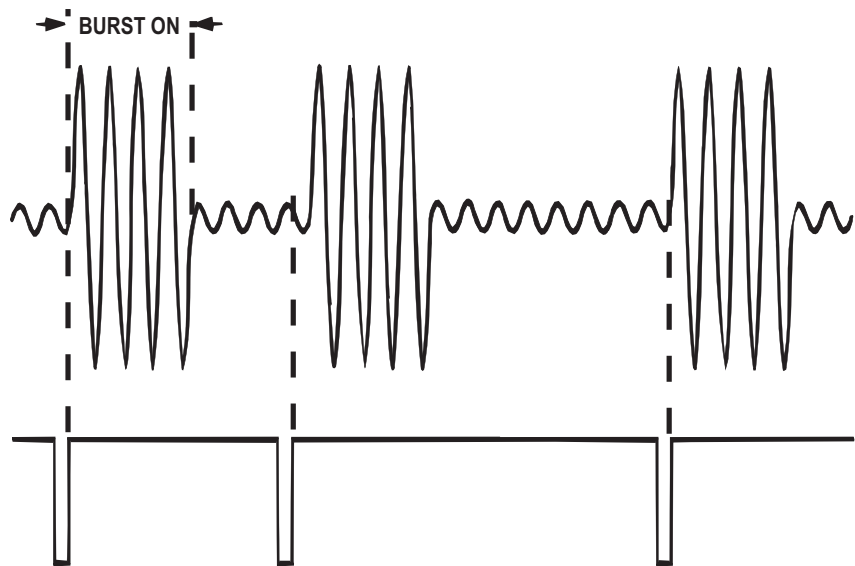

Figure 4-6 Burst Triggered Mode, Definitions

the next trigger. If the TRIG/GATE input drops to the low logic level during a burst, it will gate the signal off (terminate the burst prematurely) at the next positive-going zero crossing of the sinewave.

Bursts will always consist of an integral number of cycles, beginning and ending at positive-going zero crossings. Thus, there may be a delay of up to one sinewave period between the positive-going trigger pulse at the external connector and the beginning of the burst.

### Gated Bursts

Gated operation (Burst Gated mode) allows an external signal at the TRIG/GATE connector to control whether the generator output amplitude is at the upper value (Analog Generator panel Amplitude setting) or the Low Level value. Positive, LSTTL-compatible logic conventions are used. Thus, the sinewave amplitude will be at the upper level when the trigger/gate input is high and at the Low Level when the input is low. When no external control device is connected to the TRIG/GATE input, it is pulled high by an internal resistor and the generator output will be at the high level. The actual output gating always takes place at positive-going zero crossings, so there can be up to a one-period delay at both the gate-on and gate-off transitions. The

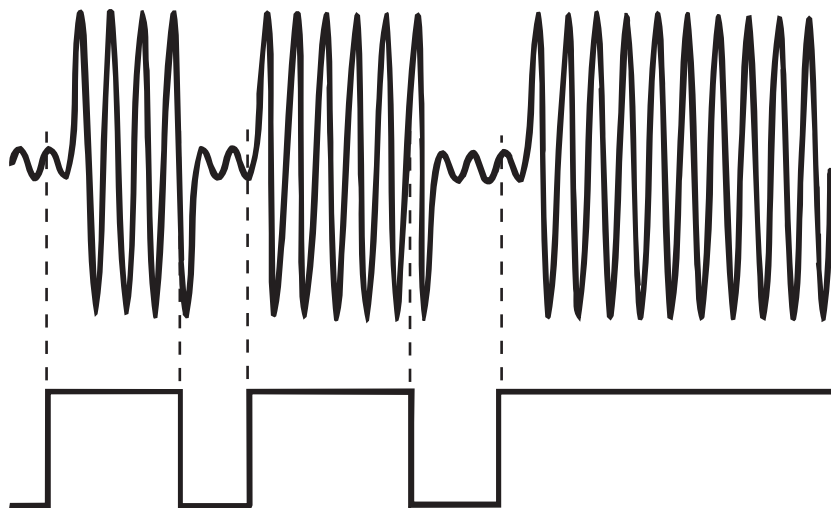

Figure 4-7 Burst Gated Mode, Definitions



figure shows the timing and logic relationships in Burst Gated mode. Note that the TRIG/GATE input connector is functional in the Burst Normal, Burst Gated, and Burst Triggered modes. If this control input is pulled to a logic low condition, it will gate the signal to the Low Level amplitude even during internally-controlled burst mode or during an externally-triggered burst.

## Sine EQ Sine—Generator Equalization

Real-time generator equalization of sinewave amplitude can be applied to the analog and digital generator and the jitter signal generator of System Two Cascade's DIO section. Equalization works by specifying an amplitude vs. frequency curve in the form of a specific filename and data column within the file. Sine EQ Sine must be selected as the waveform. Equalization function starts with the user-specified amplitude value, looks up (interpolating when necessary) the correction factor in the equalization file for the generator frequency presently in use, and sends the corrected amplitude command (post-EQ amplitude) to the instrument. The Post-EQ field shows the actual output level from the generator circuitry delivered to the external load, after adjusting the user-requested (pre-EQ) value by the value from the EQ file for the generator frequency currently in use. User entries may be made into either normal (pre-EQ) or post-EQ fields and the other field will be adjusted automatically. If a frequency value outside the frequency range span of the EQ file is entered on the generator panel or occurs during a sweep, the post-EQ amplitude will go to zero.

### Specifying the EQ Curve

Equalization will not occur until a file and column have been specified and the Sine EQ Sine waveform has been selected. The equalization file may be selected before or after selecting the EQ sine waveform. It is typically faster to first select the Sine EQ Sine waveform, since that results in a message that no file has been selected and the opportunity (by clicking the Yes button in the dialog) to select one. A browser appears which permits navigating to any desired directory and selecting a .ADQ file name. More than a dozen .ADQ files are furnished with APWIN, all located in the C:\APWIN\EQ directory. It is also possible to create your own custom EQ files as

described later. After selecting the file, you must select a column that contains amplitude data. The furnished .ADQ files are all two-column files with frequency in column 1 and amplitude in column 2. The “Edit” button on the browser may be clicked to display, and edit if desired, the EQ curve data in the Data Editor.

If you prefer to select the file and column before selecting EQ sine waveform, click on the “EQ Curve” button on the generator panel. This displays the same browser just described. Actual equalization will not take place until the Sine EQ Sine waveform is also selected. When the Sine EQ Sine waveform is selected, the generator amplitude field or fields will display the setting in blue characters rather than the normal black. If Sine EQ Sine waveform is selected without an equalization file and column having been specified, APWIN software considers the equalization factor to be unity at all frequencies, so no equalization takes place.

When the analog generator is swept in Sine EQ Sine waveform with a .ADQ file attached, the generator amplitude is momentarily

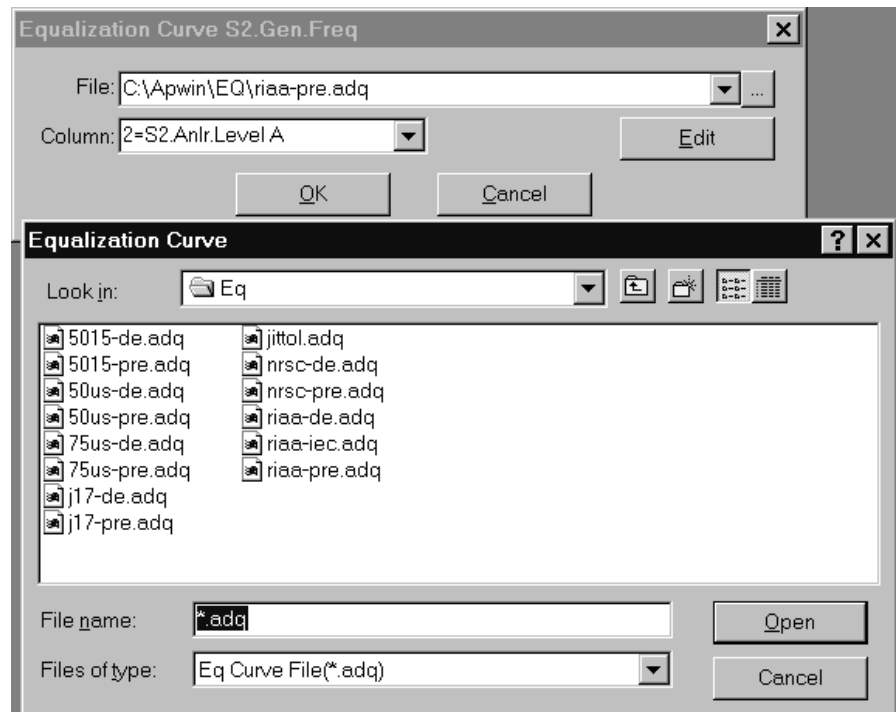

Figure 4-8 EQ Curve Selection Dialog and Browser

reduced to zero before either the frequency or amplitude is changed. After both the new frequency and new amplitude commands have been sent to the hardware, the generator output is then brought back to the new level. This technique prevents over-voltage transients that could damage sensitive devices such as loudspeakers or high-power amplitude-modulated transmitters.

## Typical EQ Applications

The most common applications of generator equalization are to produce a nominally-flat output from a device that contains a known equalization function. Typical examples include fm and TV aural broadcast transmitters with 50 and 75 microsecond preemphasis curves, rf signal generators driving broadcast receivers with 50 and 75 microsecond deemphasis characteristics, phonograph preamplifiers with RIAA deemphasis networks, and the recording or playback section (individually) of a tape recorder with its equalization circuits. By connecting an equalization curve to the System Two Cascade generator which is the inverse of the nominal curve used in the device under test, the resulting measured output should be nominally flat. Small variations from flatness will be a measurement of the accuracy of equalization in the device, since the .ADQ curves furnished are accurate to better than 0.01 dB and the specified generator flatness is of the same order.

Another application of generator EQ plus the Compute utilities is correcting for the small, intrinsic non-flatness of the System Two Cascade generator and analyzer and the cables which connect the instrument to the device under test. This is particularly important when long cables are used. The process is to first run a frequency response measurement on the instrument with the cables that normally will go to the device under test connected together. Use the Compute Invert utility to turn this measurement upside down. Use Compute Normalize, if necessary, to push the curve up or down so that it goes through zero gain at the frequency which you wish to use as a reference (often 1 kHz). Use the Save As menu command to save this curve as an EQ file (.ADQ). Select this file as the generator EQ Curve and select Sine EQ Sine as the waveform. A response curve should now show almost perfectly flat response, with the generator equalization compensating for the total measured non-flatness of the

system (including cables) at each frequency. Most exact equalization will result if the Sweep Settling tolerance for the measured parameter is tightened beyond normal and if the reading rate is forced to 4/sec to get the best possible resolution.

User-made EQ files may be viewed in tabular format and edited by use of the Edit button in the “EQ Curve” dialog, as discussed above. To view an EQ file graphically, use the File Open EQ command. Note that opening an EQ file does not change the Sweep panel settings, so it may be necessary to change Data 1 units and Optimize the graph for the desired display.

## Sine (D/A)

---

All these waveforms are DSP-generated signals routed through stereo D/A converters to the analog output and thus require that a DSP module be present. Generally speaking, they will have superior frequency resolution and stability to the analog-generated sinewave, but distortion will be slightly higher due to the D/A converter limitations.

### Sine (D/A) Normal

This is a standard DSP-generated continuous sinewave of the frequency specified in the control fields.

### Sine (D/A) Var Phase

This selection produces the specified frequency at both Channel A and B outputs, but the phase of the Channel B output is variable from -180 to +179.9 degrees with respect to the Channel A output as controlled by the Phase field.

### Sine (D/A) Stereo

This waveform selection produces independent sinewaves on Channel A and Channel B. The Frequency field sets the frequency of the Channel A signal and the Frequency 2 field sets the frequency of the Channel B signal. Their amplitudes are independently set by the two Amplitude fields unless the Track A box is checked, in which case

the amplitudes are equal and controlled by the Channel A Amplitude field.

### Sine (D/A) Dual

This selection produces two independent sinewave which are sent to both output channels. The Frequency and Frequency 2 fields permit each sinewave to be set independently. The Dual Ampl Ratio field allows the user to set the amplitude by which the Frequency 2 field signal will be attenuated with respect to the amplitude of the Frequency field signal. The Sine Dual signal is particularly useful as a calibration signal for harmonic distortion analyzers, where the Frequency signal at reference amplitude represents the fundamental signal. The Frequency 2 field sinewave is set to any desired harmonic of the Frequency “fundamental”, at an amplitude to represent any desired distortion level. For example, Frequency at 1 kHz and Frequency 2 at 3 kHz with a Dual Amp ratio of -40.0 dB (1%) furnishes a 1 kHz signal with third harmonic distortion of 1.0%.

### Sine (D/A) Shaped Burst

A shaped burst, like a normal burst, consists of the sinewave frequency selected in the Frequency field, duration set in the Burst On field, and interval between the start of consecutive

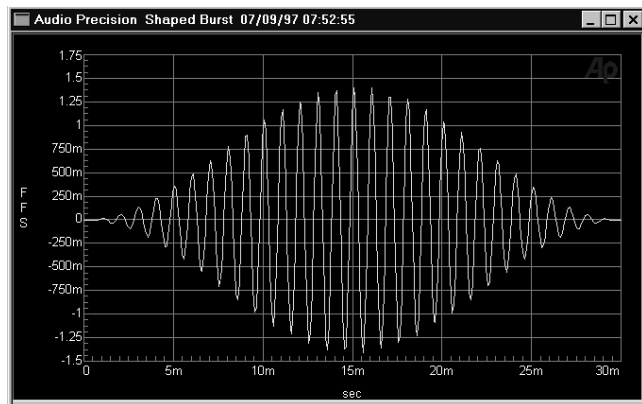

Figure 4-9 Shaped Burst Example

bursts as selected in the Interval field. The shaped burst differs in that the envelope of its amplitude follows a raised cosine shape rather than the rectangular shape of the normal burst. The shaped burst energy is contained within a narrower spectrum around the sinewave frequency than the normal, rectangular burst.

## Sine (D/A) EQ Sine

The equalized sine function of the D/A generator works exactly the same as for the hardware-generated sinewave signal described above.

## IMD

The analog hardware generated IMD waveforms require the optional intermodulation distortion (IMD) generator circuit board that mounts in the upper left compartment with the other analog generator modules. It generates one of several selected signals which is combined with the sinewave from the main analog oscillator and fed to the output stage.

Intermodulation Distortion test

waveforms are selected from the Waveform

fields, similarly to all other waveforms. Clicking the down arrow at the right of the first Waveform field will display a list of waveforms including IMD. When IMD is selected, the second waveform field shows selections of SMPTE 1:1, SMPTE 4:1, CCIF, DIM30, DIM B, and DIM 100. Click the desired signal choice.

Amplitude of IMD test signals is controlled from the Analog Generator Amplitude field. All the IMD waveforms are calibrated to produce the same peak-to-peak signal amplitude that would be produced by a sinewave of the entered value. Thus, the  $V_p$  and  $V_{pp}$  units will exactly describe the IMD waveform peak or peak-to-peak amplitude. With all other units, the IMD signal peaks will be 1.414 times the indicated amplitude (peak-to-peak, 2.828 times the indicated amplitude). The measured RMS value of all IMD waveforms will be different from the RMS value of a sinewave of the same peak amplitude. The applications advantage is that a device under test will not go into clipping when the signal is changed from a sinewave to an

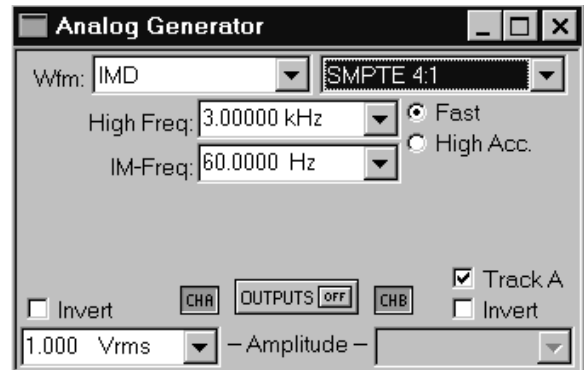

Figure 4-10 IMD Control Fields

IMD signal at the same generator panel Amplitude value, but could clip if the true RMS value were constant between all waveforms.

### IMD SMPTE/DIN

In the SMPTE/DIN waveform modes, the IMD generator board generates a sinewave at one of eight frequencies—40, 50, 60, 70, 100, 125, 250, or 500 Hz. This low-frequency sinewave is linearly combined in either a 4:1 amplitude ratio (IMD SMPTE/DIN 4:1) or 1:1 amplitude ratio (IMD SMPTE/DIN 1:1) with the variable-frequency sinewave from the main oscillator. For compatibility with the IMD analyzer module, the main oscillator frequency must be 2.0 kHz or higher. The amplitude of the combined IMD test signal is calibrated at the same peak-to-peak value as a sinewave of the value set in the Generator Amplitude field.

### IMD CCIF/DFD

In the CCIF/DFD (difference tone) mode, the signal from the main sinewave oscillator is fed to one input of a balanced modulator and the selectable low-frequency signal generated on the IMD generator board is fed to the other input of the balanced modulator. The output from the balanced modulator is a double sideband suppressed carrier signal, where the main oscillator is the suppressed carrier, with equal-amplitude sidebands spaced above and below the suppressed carrier frequency. The spacing between the upper and lower sidebands is selected by the IM-Freq field. The main generator Frequency field determines the frequency of the suppressed carrier, which is thus the center frequency between the two IMD signals. The amplitude of the combined IMD test signal is calibrated at the same peak-to-peak value as a sinewave of the value set in the Generator Amplitude field.

### IMD DIM (TIM)

DIM stands for Dynamic Intermodulation. An alternate frequently-used term is TIM, for Transient Intermodulation. In all DIM waveforms (DIM 30, DIM 100, and DIM B), a squarewave at a frequency near 3 kHz is generated on the IMD generator board and is linearly combined with the sinewave from the main generator. The

peak-to-peak amplitude ratio of the squarewave to the sinewave is 4:1. The amplitude of the combined IMD test signal is calibrated at the same peak-to-peak value as a sinewave of the value set in the Generator Amplitude field.

For the DIM 30 and DIM 100 waveforms, the squarewave frequency is 3.15 kHz and the main oscillator must be set to a frequency of 15 kHz in order for analysis to be made by the IMD analyzer board. The squarewave is passed through a single pole 30 kHz low pass filter in the DIM 30 waveform and through a single pole 100 kHz low pass filter in the DIM 100 waveform. For the DIM B waveform (B standing for broadcast), the 30 kHz low pass filter is also used, the squarewave frequency is set to 2.96 kHz, and the main oscillator sinewave frequency must be set to 14 kHz for proper analysis by the IMD analyzer.

## **IMD (D/A) Waveforms**

Like all other waveforms of the (D/A) category, a DSP module must be present for these waveforms to be available. The six secondary choices are SMPTE/DIN 4:1, CCIF/DFD, SMPTE/DIN 1:1, DIM 30, DIM B, and DIM 100.

### **IMD (D/A) SMPTE/DIN 4:1 AND 1:1**

These selections generate two sinewaves. The frequency of the reference amplitude signal is controlled by the IM-Freq field and may be freely set in the range from 40 to 500 Hz. The frequency of the high-frequency sinewave is controlled by the High Freq field and may be freely set in the range from 2 kHz to 30.3 kHz when the D/A Bandwidth field is set to 30k, or up to 60.6 kHz when D/A Bandwidth is set to 60k. The amplitude ratio of the IM-Freq sinewave to the High Freq sinewave is either 4:1 or 1:1, controlled by the waveform selection field. The amplitude of the combined IMD test signal is calibrated at the same peak-to-peak value as a sinewave of the value set in the Generator Amplitude field.

### **IMD (D/A) CCIF/DFD**

The CCIF/DFD mode produces two equal-amplitude sinewaves. The spacing between the two sinewaves is controlled by the IM-Freq



field. The acceptable range for spacing is from 80 Hz to 2 kHz. The two signals are spaced by this amount around a center frequency value controlled by the Center Freq. field, but no signal is generated at the Center Freq value. The acceptable range for the Center Freq value is from 3 kHz up to approximately the D/A Bandwidth value, minus one half the IM-Freq value. The amplitude of the combined IMD test signal is calibrated at the same peak-to-peak value as a sinewave of the value set in the Generator Amplitude field.

### IMD (D/A) DIM

The three DIM selections all produce a combined squarewave and sinewave test signal for dynamic intermodulation distortion testing. The squarewave signal is at 3.15 kHz for DIM 30 and DIM 100, and 2.96 kHz for DIM B. The squarewave is hardware-generated and thus not limited by sample rate considerations. The squarewave is band-limited at 30 kHz in the DIM 30 and DIM B selections, and at 100 kHz in the DIM 100 selection. The sinewave signal peak amplitude is one-fourth the squarewave peak amplitude. The sinewave is at 15 kHz in the DIM 30 and DIM 100 selections and 14 kHz in DIM B. These signals are compatible with the analog hardware IMD analyzer option.

### Squarewave

Square is the only waveform selection that does not require a subsidiary waveform field. Selecting Square will produce squarewaves from the generator output when the BUR-GEN module is installed. The squarewave is calibrated in peak equivalent sinewave terms. Thus, selecting a squarewave with an Amplitude value of 1.000 Vrms on the analog generator panel will produce a 2.828 V peak-to-peak signal. The maximum available amplitude of the squarewave is limited to half the amplitude selectable in Sine waveform. The frequency range for squarewaves is from 20 Hz to 20 kHz. Note that the generator configuration balanced-unbalanced selection must match the external load. Connecting to an unbalanced load from the balanced output configuration will produce distorted squarewaves.

## Noise

Several varieties of noise waveforms are available from the BUR-GEN option. Both the Noise and Pseudo Noise selections produce noise waveforms. Pseudo Noise synchronizes with the 4/second reading rate of the analog analyzer to produce stable, repeatable measurements. Noise (true random) waveforms have a continuous spectrum and produce measurements that do not repeat from reading to reading. Spectral distribution in either mode may be chosen between pink noise, white noise, or 1/3 octave bandpass filtered noise. The white noise selections are bandwidth-limited to 23 kHz.

### Noise Waveforms

Selecting Noise as waveform displays a subsidiary list of combinations of Pseudorandom or true random waveforms with several frequency distributions. The BUR option must be installed in order to obtain any of these waveforms. The Noise Pseudo waveforms produce noise which is random during a 262 millisecond period, but which then repeats every 262 milliseconds. This repetition cycle synchronizes with the nominal 4/sec reading rate of the analyzer, producing stable displays. The Noise Random waveforms are truly random and never repeat. Readings made using Noise Random waveforms will not be stable at any reading rate. The noise spectrum in the Noise waveforms will have energy at all frequencies within its specified bandwidth; that is, the spectral lines will be infinitesimally closely spaced. In Noise Pseudo waveforms, the spectral lines will be spaced at the repetition rate of the pseudorandom cycle, or approximately every 3.8 Hz to the upper bandwidth limit. This signal may not be acceptable for certain applications, particularly at very low frequencies. However, if the measurement interval is limited, it does not seem good to have a noise signal which repeats less often.

Amplitude calibration in the Noise Pseudo waveforms is in terms of equivalent sinewave peak, as with other complex waveforms such as intermodulation test signals and squarewaves. The Noise Pseudo waveforms of the BUR-GEN have a crest factor (ratio of peak to RMS) of 4:1 (12 dB). Since a sinewave has a crest factor of 1.414:1 (3 dB), the RMS value of the Noise Pseudo waveforms at any given Amplitude

setting will be 9 dB less than that of a sinewave at the same Amplitude. In the Noise Random waveforms, amplitude calibration is approximately the same RMS value as in Pseudo Noise waveforms. The result is that in Noise Random waveforms, occasional noise peaks may exceed the peak-to-peak value of a sinewave of the same Amplitude. While the theoretical crest factor in Noise Random waveforms is infinite, a 4:1 crest factor will be exceeded only 0.01% of the time. The maximum available Amplitude setting in the noise modes is half that of the sinewave modes.

In either Noise Pseudo or Noise Random waveforms, additional selections of the noise spectral distribution may be made among Pink, White, or BP (Bandpassed).

### White Noise

The Noise White and Pseudo Noise White waveforms select white noise mode. This waveform is bandwidth limited to 23 kHz to maximize the noise energy falling within the audio band. The spectral distribution of white noise is characterized by equal noise energy per Hz of bandwidth. The spectral range between 100 Hz and 200 Hz will thus have the same energy as the range between 10,000 Hz and 10,100 Hz. If analyzed by a constant bandwidth spectrum analyzer such as a superheterodyne or FFT analyzer, white noise will show a flat energy characteristic versus frequency (up to the bandwidth limitation). Analysis with a constant-percentage-bandwidth (constant Q) filter such as in bandpass mode (or most real-time analyzers) will show a rising characteristic versus frequency, at the rate of 3 dB per octave.

### Pink Noise

The Noise Pink and Pseudo Noise Pink waveforms select pink noise mode. Pink noise is characterized by equal noise energy per fractional octave, fractional decade, or equal percentage bandwidth. Thus, the octave of pink noise between 5 kHz and 10 kHz will contain the same energy as the octave between 300 Hz and 600 Hz. A constant-percentage-bandwidth analyzer such as bandpass mode and most real-time audio analyzers will show a flat characteristic with frequency. A constant bandwidth spectrum analyzer such as a superheterodyne or FFT analyzer will display pink noise as having a

fall-off with increasing frequency, at the rate of 3 dB per octave. The BUR-GEN's pink noise is generated by filtering the basic white noise source through a 3 dB per octave filter. Pink noise will sound subjectively flat to the ear because the sounds are perceived on a constant bandwidth basis. When checking response of devices such as multiway loudspeaker systems, pink noise will supply more equal levels to low, midrange, and high frequency drivers than will white noise.

### Noise Bandpassed Waveform

Noise BP (Bandpassed) and Pseudo Noise BP (Bandpassed) waveforms select the pink noise waveform, but further process the noise by passing it through a two pole 1/3 octave tunable bandpass filter whose center frequency is controlled by the Frequency field of the Analog Generator panel. This filter is, in fact, the basic state-variable oscillator circuit of generator, used as a bandpass filter. The filter center frequency can thus be tuned from 10 Hz to 204 kHz. The center frequency is controlled from the Generator Frequency field and can be swept at either Source-1 or Source-2 on the Sweep panel. Units may be Hz and kHz or any of the generator relative frequency units.

### Noise Burst USASI

The Noise Burst USASI waveform selects a special two-level modulated waveform with noise spectral distribution similar to voice and music program material. The Federal Communications Commission in the U.S.A. specifically calls out this waveform as a modulation source while using a radio-frequency spectrum analyzer to measure the occupied bandwidth of amplitude modulated broadcast transmitters.

There is no frequency field for the Noise Burst USASI waveform. The Channel A and B Amplitude fields control amplitude at the two channel outputs. Calibration of the Amplitude field is the RMS value of a sinewave of the same peak-to-peak value as the waveform presently being generated.

## Arbitrary Waveforms

The Arb Wfm (D/A) waveform selection (Arbitrary Waveform) permits DSP-based generation of waveforms which have been stored as binary files on computer disk. These are typically multitone waveform files used for rapid measurements of response, distortion, noise, phase, and crosstalk/separation. When Arb Wfm (D/A) is selected, a second field labeled Waveform appears, with an ellipsis button at the right to permit browsing among directories (folders) to select the desired waveform file. A number of useful waveform files are furnished by Audio Precision in the C:\APWIN\WAVEFORM directory. The user may create his own multitone waveform files by use of the Utilities Multitone Creation feature of the Utilities menu. Operation of this capability is described the FFT-Based DSP Programs chapter, beginning on page 15-26.

Files displayed are of both the .AGM (generator, monaural) and .AGS (generator, stereo) file types. A .AGM monaural file consists of a single waveform, which will be loaded into both the left and right channel generator buffers for signal generation. A .AGS stereo file consists of two waveforms concatenated into one file. The first waveform in the file loads into the left channel generator buffer and the second file into the right buffer.

The D/A converter sample rate for Arbitrary Waveform files is controlled by the D/A Sample Rate field in the lower section of the large form of the Analog Generator panel. If the “Set Sample Rate When Loading Generator Waveforms” box on the General tab of the Utilities Configuration dialog is checked, loading a waveform file will also force the D/A Sample Rate field to the proper selection and, if necessary, enter the correct numeric value into the Output Sample Rate (OSR) field on the DIO panel to produce the intended frequencies in the multitone signal. For example, loading a file created for use at a 48 kHz sample rate will cause the D/A Sample Rate field to change to OSR (Output Sample Rate) and the OSR field on the DIO panel will have 48.000 kHz entered into it. If this box on Utilities Configuration is not checked, the user is responsible for determining what sample rate the waveform file requires and manually setting the rate properly. If the actual sample rate does not correspond to that used when the file was created, all frequencies will be shifted up or down by the ratio of

the two sample rates. If the analyzer (FASTTEST or FFT) sample rate is not identical to the D/A Sample Rate, the signal will not be synchronous in the analyzer buffer and window functions must be used.

### MLS (Maximum Length Sequence) Waveforms

The analog generator can generate sixteen variations of a Maximum Length Sequence. A Maximum Length Sequence (MLS) is a pseudo random noise signal with the property that, when passed through a device and cross-correlated with the input signal to the device, the result is the impulse response of the device. An FFT can then be performed on the impulse response to yield the frequency and phase response of the device. See the Quasi-Anechoic Acoustical

Tester (MLS) section of the FFT-Based DSP Program Chapter for a more complete description.

### Special Polarity

**Special (D/A) Polarity** is a signal consisting

of two sinewaves, a fundamental and second harmonic, phased so peaks reinforce each other in the positive direction and oppose in the negative direction. The polarity waveform at the output of the device under test, displayed in the time domain by the FFT program as illustrated, will then show whether a phase inversion has taken place in the device or cable under test.

### Special Pass Thru

The Special (D/A) Pass Thru “waveform” takes the imbedded audio signal present on the rear panel AES/EBU Ref In XLR connector, converts it to the analog domain, and furnishes it to the analog output stages. A digital full-scale (1.000 FFS or 0 dBFS) sinewave signal at the AES/EBU Ref In connector results in normal calibration of the

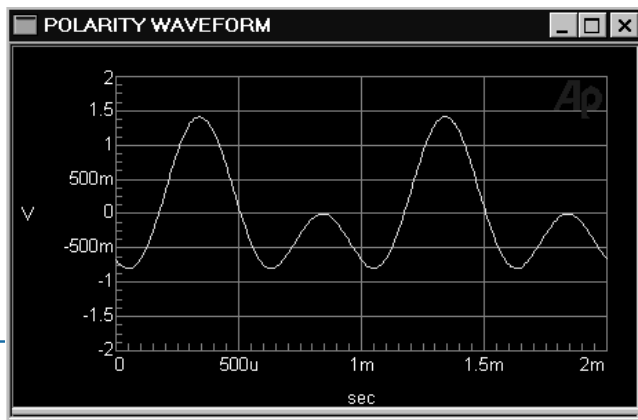

Figure 4-11 Polarity Waveform, No Inversion

analog generator output amplitude. The Sync/Ref panel must be set to AES Sync Rate as the Source and the button to the right of the Source field must be turned ON for proper operation of Pass Thru.

## Waveform Parameter Interactions

---

Note that there are interactions between maximum available amplitude and waveform, frequency, and output configuration. Maximum available sinewave amplitude at the frequency extremes (below 20 Hz, above 50 kHz) is half that at standard audio frequencies. Maximum amplitude with noise and square waveforms is half that with sinewaves. Squarewaves are not available across the full 10 Hz-204 kHz frequency range of sinewaves.

## Frequency Control and Units

---

The frequency of most waveforms is controlled by the Frequency field. Except for the Noise-BP selections, noise waveforms have no controllable frequency parameter so the Frequency field disappears. In the SMPTE-DIN and CCIF IMD waveforms, a second frequency parameter may be selected so an IM Frequency field will be displayed just below the main frequency field.

Note that there are interactions between maximum available amplitude, waveform, and frequency. Maximum available sinewave amplitude at the frequency extremes (below 20 Hz, above 50 kHz) is half that at standard audio frequencies. The available frequency range in squarewave is from 20 Hz to 20 kHz.

Frequency may be expressed in absolute units (Hz) and in a variety of units relative to the Reference Frequency value near the bottom of the Analog Generator panel. The Frequency box is a numeric entry field.

To change the Frequency units (for example, from Hz to octaves), click on the down arrow at the right end of the Frequency box. Select the desired new unit by clicking on one of those available in the list that appears.

Note that changing units does not change the frequency of the generator. The existing frequency will simply be re-stated in the new

units. Note also that the value displayed after pressing  may differ slightly from the value entered, since APWIN software will display the nearest frequency which the instrument can actually generate.

The IM Frequency field is selected in the same manner as the main frequency field. However, the IM generator option has only eight fixed choices for IM frequency. If a value is entered into this field from the keyboard, APWIN software will select the nearest IM frequency from the available choices.

### Fast-High Accuracy Modes

These modes pertain only to the analog hardware sinewave generator. Fast mode produces the most rapid frequency settling along with frequency accuracy and resolution suitable for nearly all audio tests. High accuracy mode provides greater accuracy and resolution, but requires from 150 milliseconds (above 50 Hz) to 750 milliseconds (at 10 Hz) for complete settling each time the frequency is changed.

### Output On/Off and Channel Selection

The Outputs On-Off button turns on or off the output channels whose individual channel output control buttons are ON. The Outputs On-Off button is a “toggle” function, reversing output conditions each time it is pressed. When off, outputs are reverse-terminated in the selected source impedance.

The CH A and CH B channel selection buttons determine whether output channel A, B, both, or neither will have signal present when the Outputs On-Off button is On. The lowest noise and signal feed-through condition is obtained by turning the Outputs On-Off button off rather than turning an individual channel off. The System Two Cascade Analog Generator has two power amplifiers and output transformers, so different signals can be present at each output when they are both selected and the Sine (D/A) Stereo waveform is selected.

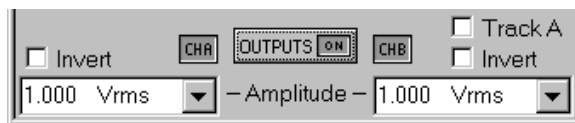

Figure 4-12 Outputs On-Off and Channel Select Buttons



## Channel Invert

---

Either channel may be phase-inverted (180 degrees) by checking the Invert box near the Outputs On-Off button. Phase inversion of one channel with respect to the other is used to create subcarrier rather than main carrier output in stereo multiplex systems. When neither box is checked or both boxes are checked, the two outputs are in phase.

## Amplitude Control and Units

---

The output amplitude of each channel is determined by the setting in that channel's Amplitude field unless the Track box is checked, in which case the Channel A Amplitude field controls both channels. Amplitude may be stated in a variety of practical units. A new amplitude value may be entered or the existing value edited from the keyboard, followed by . Note that there are interactions between maximum available amplitude and waveform, frequency, and output configuration. Maximum available amplitude at the frequency extremes (below 20 Hz, above 50 kHz) is half that at standard audio frequencies. Maximum amplitude in unbalanced configurations is half that in balanced mode. Maximum amplitude with noise and square waveforms is half that with sinewaves.

Note that the actual output amplitude does not change when units selections are changed, but the existing amplitude is simply re-stated in the new unit. Note also that the value displayed after pressing  may differ slightly from the value entered, since APWIN software will display the nearest amplitude which the instrument can actually generate.

## Track A

---

System Two Cascade analog generator output channels A and B have separate amplitude control circuitry and can be independently set. For most audio applications, the same amplitude will be desired at both. In these cases, it is more convenient to make only one Amplitude setting that will be furnished at both channels. Check the Track A box for this mode. The B channel Amplitude field will become gray and entries in the A Amplitude field will control both channels.

### Output Configuration

The generator outputs may be configured as balanced or

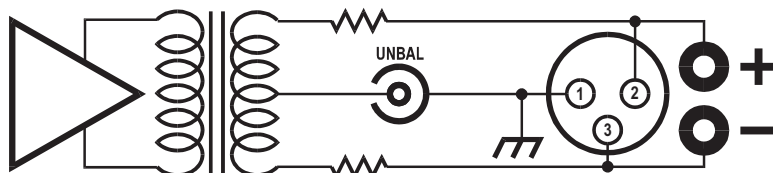

Balanced Floating

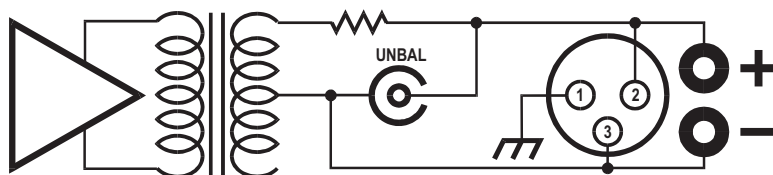

Unbalanced Floating

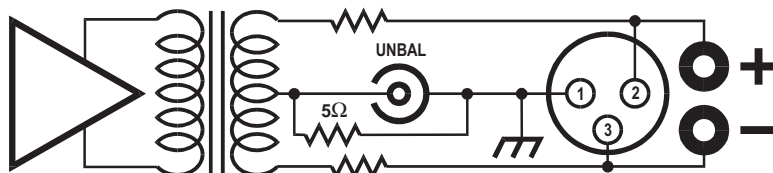

Balanced Grounded

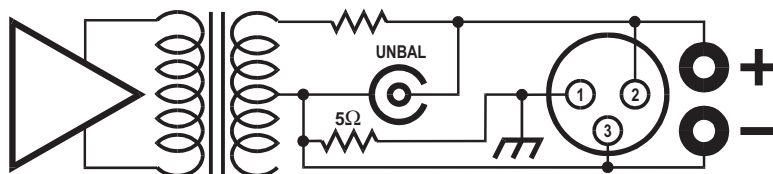

Unbalanced Grounded

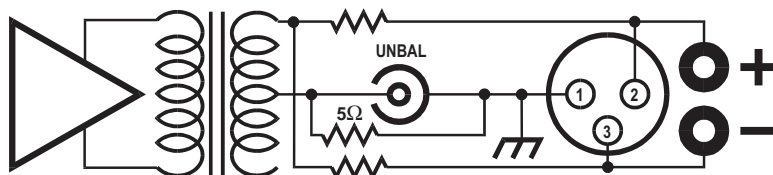

Common Mode Test

Figure 4-13 System Two Analog Generator Output Configurations. Only One Channel Shown; Both Channels Identical

unbalanced and floating or grounded. Additionally, a common mode rejection ratio test configuration is available to simplify measurement of CMRR of a device input. Configurations of both channels A and B are slaved together.

Note the interaction between Configuration and Z-Out (output impedance). The output impedance buttons that are not available in any configuration will be gray and non-functional.

In the **balanced** output configuration, the two ends of the output transformer drive pins 2 and 3 or the XLR connector and the + and - banana jacks. Half of the selected output impedance is connected in series with each leg. The center conductor of the BNC connector connects to the transformer center tap and may be used to inject a common mode signal or to provide an AC-coupled ground reference by connecting an external capacitor to ground. This common connection is grounded or floating, depending upon the selected configuration. When grounded, a PTC (positive temperature coefficient resistor) is connected between center tap and ground as a protective device. Only one channel is shown in the diagram, but both channels are identical.

In the **unbalanced** output configuration, only half the transformer secondary is used. Pin 2 of the XLR, the center conductor of the BNC, and the + banana jack connect to the top end of the output transformer through the selected output impedance. The center tap of the transformer connects directly to pin 3 of the XLR, the shell of the BNC, and to the minus banana jack. If the output configuration is selected as ground, that common conductor is also connected to ground through the PTC protection device (see above). Since only half the transformer secondary is used in unbalanced configuration, the maximum available amplitude is half that (6.02 dB less) of balanced configuration. Only one channel is shown in the diagram, but both channels are identical.

In the **CMTST** (common mode test) configuration, only half the transformer secondary is used so maximum available amplitude is half that of the balanced configuration. The top of the transformer secondary connects to two resistors, each half of the selected output impedance value. One of those resistors drives pin 2 of the XLR and

the + banana jack and the other resistor drives pin 3 of the XLR and the minus banana jack. The transformer center tap connects to ground through the PTC protection device (see above) and to the center conductor of the BNC. Thus, XLR pins 2 and 3 (or the + and - banana jacks) are driven with equal amplitude, in-phase signals with respect to ground. This type of signal will be largely rejected by well-designed balanced (differential) inputs. Only one channel is shown in the diagram, but both channels are identical.

## Impedance Selection

Generator output impedance may be selected as 40, 150, or 600 Ohms in balanced configurations (40, 200, or 600 Ohms with option EURZ hardware installed and selected via the Utilities Configuration menu command). In unbalanced configurations, the available choices are 20 and 600 Ohms. The output impedance control of channels A and B are slaved together.



Except when dBm or Watts units are selected for generator amplitude, changing the output impedance does not change the open-circuit voltage (emf) behind that output impedance. With a finite load impedance, the actual terminal voltage will change as output impedance changes since the effective voltage divider ratio between source and load also changes. When dBm or Watts units are selected, APWIN computes the required open circuit voltage necessary to produce the specified power (Amplitude field) across the specified external load value (Reference dBm or Reference Watts fields). Since this open circuit voltage value also depends on generator output impedance, open-circuit voltage will change when source impedance is changed since power in the load is held constant.

## dBm Reference

When dBm units are selected in the generator Amplitude field, APWIN software computes the necessary emf (open-circuit voltage) which will cause the specified power (Amplitude field) to be delivered to the specified load impedance (dBm Reference field). Thus, the user must enter the actual value of device input impedance into the dBm Reference field for output power to be properly calibrated.



## dBr Reference

---

When dBr units are selected in the generator Amplitude field, the actual output amplitude is computed based on the decibel value entered in the Amplitude field and the dBr reference value. The present value of generator amplitude may be automatically written into the dBr Reference field by pressing the  function key or selecting the Edit Set Gen dBr Ref menu item. A new value may be entered or the existing dBr Reference value edited from the keyboard, followed by . The dBr Reference value may be stated in any of a number of amplitude units.

## Frequency Reference

---



The Analog Generator has a number of relative frequency units in addition to absolute frequency in Hz. When any relative frequency unit is selected, APWIN computes and sets the actual frequency based on the relative value in the generator Frequency field and the Frequency Reference value. The present value of Analog Generator frequency may be written into the Frequency Reference field by pressing the   keys or selecting Edit Set Generator Freq Ref menu item. A new value may be entered or the existing value edited from the keyboard, followed by .

## Watts Reference

---

When Watts units are selected in the generator Amplitude field, APWIN software computes the necessary emf (open-circuit voltage) which will cause the specified power (Amplitude field) to be delivered to the specified load impedance (Watts Reference field). Thus, the user must enter the actual value of load impedance into the Watts Reference field for output power to be properly calibrated. A new value may be entered or the existing value edited from the keyboard, followed by . To select the Watts Reference field for entry:

Mouse: Click on the Watts Reference field.

Keyboard: Shift the focus to the Analog Generator panel, if necessary, with the   keys. Select the Watts Reference field with

the **TAB** key (moves selection downwards) or **SHIFT TAB** keys (moves selection upwards).

## Analog Generator Hardware Overview

The System Two Cascade analog generator consists of an oscillator section and a dual output stage section. The block diagram shows a simplified overview. The oscillator section always includes a variable frequency low-distortion sinewave oscillator and a signal multiplexer in case other waveforms are added. The IMD option adds generation of three standard intermodulation distortion (IMD) test signals. The BUR option adds a squarewave-sine burst-noise generator. If DSP modules are present, DSP-generated signals including independent signals for the two channels may be routed from D/A converters in the DSP module through the multiplexer to the generator output stages.

### System Two Cascade Oscillator Section

The Analog Oscillator Block Diagram shows the several signal sources available in the System Two Cascade Analog Generator. The sinewave oscillator uses state-variable topology to optimize low distortion and fast settling time. Capacitors are switched to select one

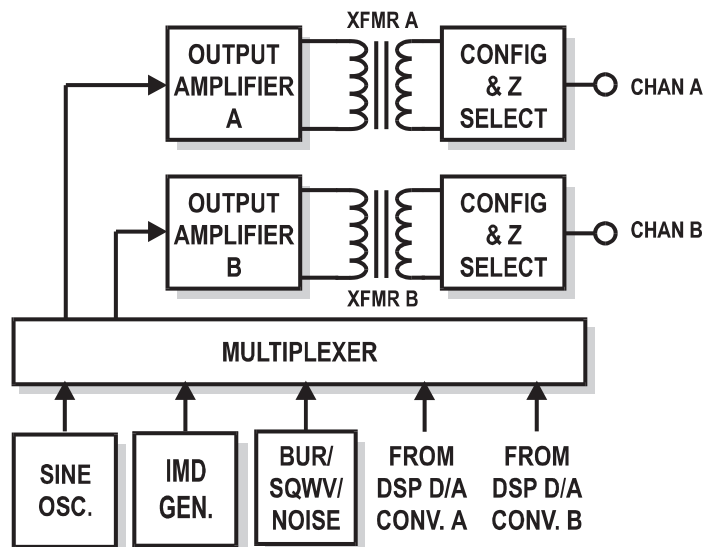

Figure 4-14 System Two Analog Generator, Simplified Block Diagram

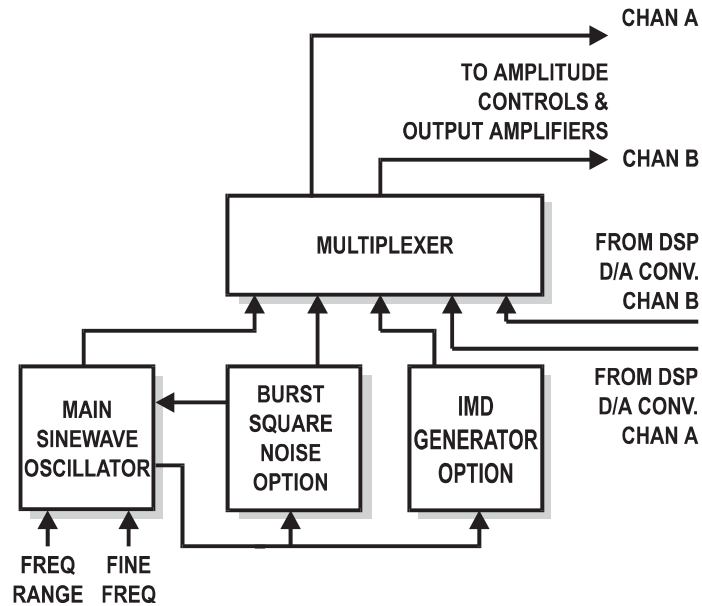

Figure 4-15 Oscillator Section, System Two Analog Generator

of four frequency ranges: 10-204 Hz, 204 Hz-2.04 kHz, 2.04 kHz-20.4 kHz, or 20.4 kHz-204 kHz. Within each range, a 13-bit MDAC serves as a variable resistor to set the oscillation frequency anywhere across the 10:1 range (20:1 on the lowest range). A Leveling circuit (not shown) operates continuously to provide output amplitude that is independent of frequency. The sinewave output feeds a multiplexer that selects among the various waveforms that may be present. The multiplexer output goes to a high-resolution (fine) amplitude control block shown in the output stage block diagram.

When the BUR (squarewave-sine burst-noise) option is present, the main sinewave oscillator output may be fed through the BUR circuit block where it can be synchronously gated or triggered. The sinewave from the main oscillator also serves as the frequency-determining source for the squarewave signal generated on the BUR circuit board. The BUR board can also generate pseudorandom or random noise of white or pink frequency distribution. In Noise-BP function, the pink noise output may be fed through the sinewave oscillator frequency-determining circuitry functioning as a 1/3-octave bandpass

filter to produce narrowband noise at any center frequency from 10 Hz to 204 kHz.

When the IMD option is present, the main sinewave oscillator provides one of the two IMD test signals in the case of the SMPTE/DIN or DIM/TIM standards. The main sinewave is combined in the IMD module in the proper amplitude relationship with either a low-frequency sinewave selected among several frequencies (SMPTE/DIN) or with a fixed-frequency squarewave (DIM/TIM), and sent to the multiplexer. For the “CCIF” (difference tone) IMD standard, the main sinewave oscillator provides the “carrier frequency” into a balanced modulator. The modulating frequency to the balanced modulator is supplied by the low-frequency oscillator in the IMD module. The resulting output from the balanced modulator is a double-sideband suppressed-carrier signal, consisting of the two equal-amplitude test tones (“sidebands”) equally spaced in frequency above and below the main oscillator frequency.

When DSP modules are present, a number of digitally-generated waveforms can be converted to the analog domain via dual D/A converters on the DSP module and routed through the analog

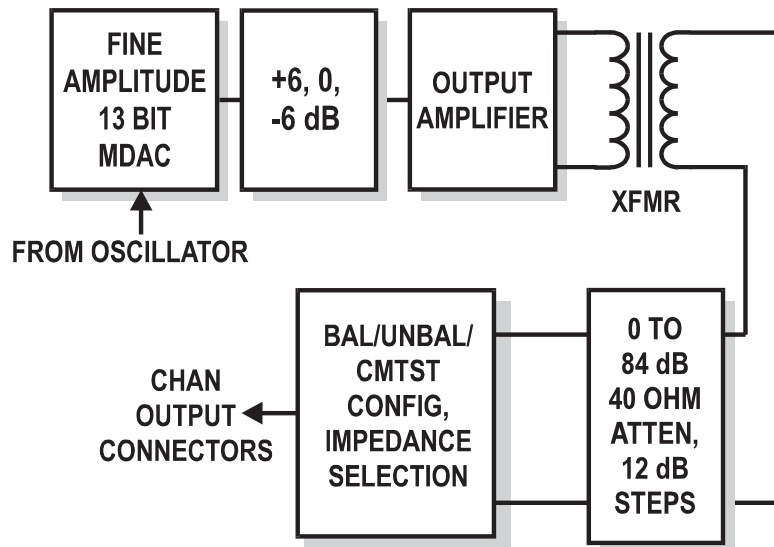

Figure 4-16 System Two Analog Generator Output Stage (Channels A and B Identical)



generator amplitude control and output stage via the DGen waveform selection. System Two Cascade's ability to furnish independent signals at outputs A and B is fully implemented only from the DGen source, by selecting either the Stereo Sine waveform or Arbitrary Waveform with a stereo waveform file downloaded.

## Analog Generator Output Stage

System Two Cascade contains two independent analog output stages that are driven from the low distortion sinewave oscillator or optional IMD or BUR-GEN modules, or dual D/A converters in the DSP module in SYS-2422 and SYS-2522 configurations. Each output stage consists of an amplitude control section, transformer-coupled power amplifier, output attenuators, and output impedance switching.

The amplitude control section uses a custom 13-bit multiplying digital-to-analog converter (MDAC) as the variable element in combination with +6, 0, and -6 dB gain switching. The transformer-coupled power amplifier provides a balanced or unbalanced output that is followed by a 0 to -84 dB attenuator in 12 dB steps. The overall amplitude resolution or "settability" is <0.003 dB worst case from maximum output down to approximately 180  $\mu\text{V}_{\text{rms}}$ . For amplitude settings below 180  $\mu\text{V}$ , resolution is limited to step sizes of approximately 50 nV (0.05  $\mu\text{V}$ ). Selectable "build-out" resistors follow the attenuator section to determine the final output impedance.

Control of these various sections is managed by APWIN software and is transparent to the user. When the value of desired output amplitude is entered by the user or during a sweep, the software automatically selects the optimum attenuator and MDAC settings to provide the highest quality output signal.



# Analog Analyzer

## Analog Analyzer Panel

The System Two Cascade Analog Analyzer contains six measuring instruments—Level Meters on each input channel, a Phase Meter, Frequency Counters on each input channel, and the Function Reading Meter. The first five meters are single-function instruments, while the Function Reading Meter is flexible with many different measurement functions. All selectable or tunable filtering and the selectable detector types are in the Function Reading Meter section.

Note that this analog hardware-implemented analyzer is one of two alternative measurement capabilities in System Two Cascade. A DSP-implemented analyzer program may also be selected on the Digital Analyzer panel and its input signal obtained via A/D converters from System Two Cascade's analog inputs. The DSP-implemented analyzer program provides many of the same measurement categories as the analog hardware analyzer, but with a different set of trade-offs. Generally speaking, the analog hardware analyzer discussed in this chapter will provide the best performance—flattest frequency response, lowest noise, lowest distortion, widest bandwidth. The DSP-implemented analyzer is capable of significantly faster operating speeds if its slightly-lower specifications are acceptable. For full information on the DSP-implemented analyzer, see the DSP Audio Analyzer chapter.

To bring the Analog Analyzer panel to the screen:

Mouse: Click on the Analog Analyzer icon  on the toolbar or select Panels Analog Analyzer via the menu bar

Keyboard: Type   or    (for Panels analog Analyzer).

The normal default start-up mode of APWIN software has the Analog Analyzer panel on page one.

The Analog Analyzer panel may be displayed in two sizes. The smaller version (displayed at start-up) shows only the most important controls and displays. Displays on the small panel are the Level, Frequency, Phase, and Function Reading meters with unit selections. Controls on the small version include input connector selection, the A-B channel selection for the Function Reading meter, and the Phase meter range selection. The large version adds input termination impedance selection controls, DC/AC coupling controls, auto-fixed range check boxes and manual range selection controls for the input ranging sections, the auto-fixed range check box and manual range selection controls for the Function Reading meter range amplifier, and controls for meter reading rate, detector type, high pass filters, low pass filters, plug-in option filters, bandpass-bandreject filter steering mode and frequency control field when fixed, and reference value fields for dBm, dBr (each channel independent), Watts, and frequency.

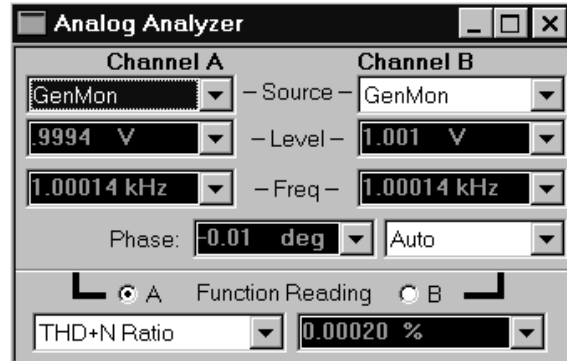

Figure 5-1 System Two Analog Analyzer Panel, Small Version

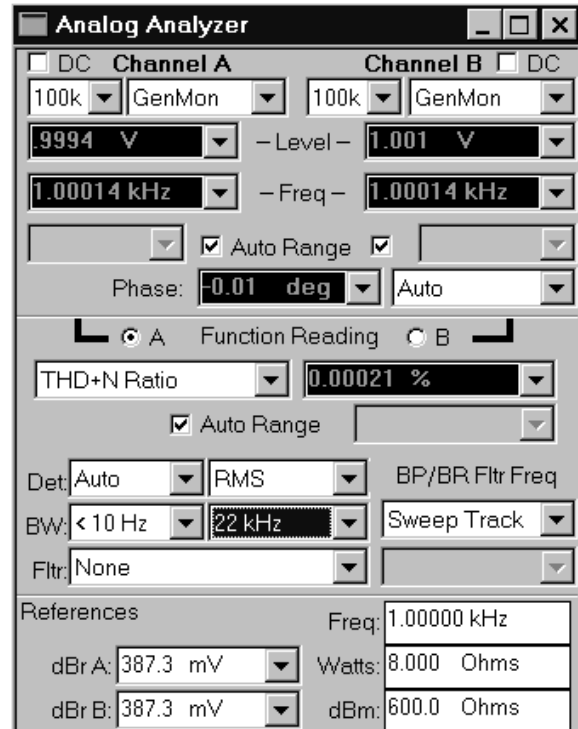



Figure 5-2 System Two Analog Analyzer Panel, Large Version

Clicking on the panel icon on the Panels Toolbar brings up the small version panel. Holding down the  key while clicking on the toolbar icon brings up the large version. To switch between the small and large panels:

Mouse: Double-click anywhere in the title bar, or click on the middle  of the three icons at the top right of the panel , in the control bar.

Keyboard: Press the   or   Arrow keys.

## Input Source Selection

The System Two Cascade Analog Analyzer input panel contains XLR, double banana, and BNC connectors for both channels. The double banana jacks are hard-wired to pins 2 and 3 on the XLR connectors on each channel. System Two Cascade also has internal cables installed from each analog generator output channel to selector relays at the corresponding analyzer input channel. The source selection field on the Source line at the top of the analyzer panel selects between the XLR/banana jack inputs in balanced configuration, the BNC jacks (unbalanced), and the generator monitor facility.

## Balanced Input Termination

The balanced inputs (XLR and banana jacks) may be terminated in 600 or 300 Ohms, or operated with a 100 kilohm bridging input resistance. Terminations for the balanced inputs are selected in the field to the left of the input source selection. The unbalanced BNC inputs are always 100 kilohms input. A 300 or 600 Ohm termination selected at a balanced input still remains connected to the XLR and banana jack input connectors even when BNC Unbal or Gen Mon is selected as the signal source of the analyzer.

## DC Coupling

System Two Cascade's analyzer circuitry is intrinsically DC-coupled from the front-panel input connectors to the connection point for the DSP A/D converters (when Anlr A or Anlr B is selected). DC coupling thus extends DSP acquisition of analog signals down to DC. DC coupling also provides superior CMRR (common mode rejection ratio)

at low frequencies, which is normally limited by mis-match in value of coupling (DC blocking) capacitors. DC blocking capacitors may be independently switched into either input channel when DC coupling is not desired.

## Level Meters

The two Level Meters measure amplitude of Channel A and Channel B. Amplitude measurements made by the two Level Meters may be independently expressed in a number of different units. Note that the dB<sub>r</sub> (relative dB) units for the A and B Level Meters have separate reference values at the bottom of the panel. To select among Level Meter units:

Mouse: Click on the down arrow at the right of either Level Meter display field to show a list of available units. Click on the desired unit.

## Frequency Counters

The two Frequency Counters measure frequency of Channel A and Channel B. Frequency measurements made by the Frequency Counters may be independently expressed in absolute units (Hz) and a number of different relative units referred to the Reference Frequency field near the bottom of the panel.

## Input Ranging Control and Manual Selection

Each input channel (A and B) includes attenuators and selectable gain amplifiers designed to bring input signals across a wide amplitude range to the optimum level for System Two Cascade's detectors. The two channels are independent. For most applications, it is most convenient (and least error-prone) to allow the Autoranging circuitry to select the proper range. For certain applications where measurements must be made on signals whose amplitude constantly changes, such as tone burst signals or program material, it may be necessary to disable autoranging and manually select a range which will handle the expected peak signal amplitude. When Autoranging is selected on either channel (Auto box is checked),



Figure 5-3 Analyzer Input Ranges Automatically Controlled

the manual range selection field is gray and non-functional. When the box is un-checked to disable

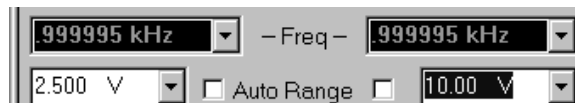

Figure 5-4 Analyzer Input Ranges Fixed at User-Entered Values

autoranging, the range field will display the full-scale value of the range which had been automatically selected. The range may be expressed in a number of different units, selectable via the down arrow at the right of the field. A different range may be manually selected.

To select a new manual range, enter the value of the largest expected signal amplitude into the range field and press . A new value may be entered or the present range setting edited from the keyboard after selecting the range field of the desired channel. APWIN software will choose the most sensitive range which will not be overloaded by a signal of the specified amplitude, and will display the full-scale value of the selected range when is pressed after making or editing an entry.

## Phase Meter Ranges

The field at the right of the Phase meter display permits selection among four phase ranges: Auto,  $-180+180$ ,  $0+360$ , or  $-90+270$ .

When **Auto** is selected, the Phase meter ranges automatically. When phase is graphed versus frequency in a sweep and the phase shift or delay through the device under test is large enough to go through more than one complete revolution, the plotted phase will be “unwrapped”. That is, phase will plot continuously through thousands of degrees if necessary, assuming that the size of the frequency steps is small enough that measured phase does not change by too large an amount from point to point.

When  **$-180+180$**  is selected, the panel display and graph plots are constrained to a range between minus 180 degrees and plus 180 degrees. Plots of phase will jump abruptly from minus 180 to plus 180 (or vice-versa) on adjacent frequency steps if the measured phase crosses the end of the range.

When **0+360** is selected, the panel display and graph plots are constrained to a range between 0 degrees and plus 360 degrees. Plots of phase will jump abruptly from 0 to plus 360 (or vice-versa) on adjacent frequency steps if the measured phase crosses the end of the range.

When **-90+270** is selected, the panel display and graph plots are constrained to a range between minus 90 degrees and plus 270 degrees. Plots of phase will jump abruptly from minus 90 to plus 270 (or vice-versa) on adjacent frequency steps if the measured phase crosses the end of the range. This range is particularly useful when measuring devices with low values of phase shift for polarity. In this case the readings are likely to be within a few

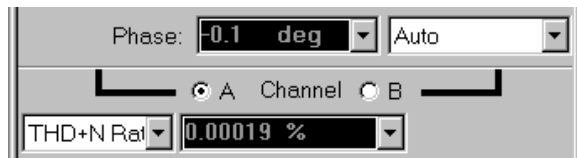

Figure 5-5 Function Reading Meter Channel A/B Selector

degrees of zero or within a few degrees of 180 and it is simple to put limits on the results of a measurement for Pass/Fail testing.

## Input Channel Selection

The buttons above the Function Reading Meter display determine whether Channel A or B is measured by the System Two Cascade Function Reading Meter.

## Function Reading Meter Function Selection

The flexible Function Reading Meter can measure a number of different audio functions by virtue of its tunable bandpass-bandreject filter, selectable bandwidth-limiting and weighting filters, and selectable detectors. The IMD analyzer option and wow and flutter option also feed their processed signals to the Function Reading Meter for final display. The complete list of measurement functions available, if

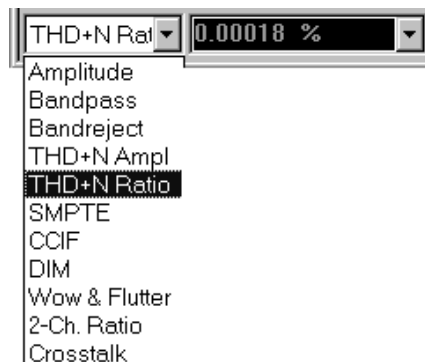

Figure 5-6 Function Reading Meter Function Selection List



the IMD analyzer and wow and flutter options are present, is shown in the figure.

### Function Reading Meter Function Amplitude

In the Amplitude function, the amplitude of the selected channel signal is measured and displayed. Detector type, reading rate, high-pass filter, low-pass filter, and plug-in option filter may be selected.

### Function Reading Meter Function Bandpass

In the Bandpass function, the selected channel signal is passed through a four-pole 1/3 octave tunable filter before its amplitude is measured and displayed in order to accomplish a frequency-selective amplitude measurement. The center frequency of the filter may be set anywhere in the range from 10 Hz to approximately 204 kHz. The filter center frequency may be made to automatically track the Source 1 or Source 2 sweeping parameter (Sweep Track), the measurement of the Frequency counter on the same channel (Counter Tuned), the analog generator (AGen Track), the digital generator (DGen Track), or to be fixed at a user-entered frequency value (Fixed) by the selection of the BP/BR Filter Freq field. Detector type, reading rate, high-pass filter, low-pass filter, and plug-in option filter may be selected.



Figure 5-7 Function Reading Meter BP/BR Steering

### Function Reading Meter Function Bandreject

In the Bandreject function, the selected channel signal is passed through a tunable bandreject (notch) filter before its amplitude is measured and displayed. The center frequency of the filter may be set anywhere in the range from 10 Hz to approximately 204 kHz. The filter center frequency may be made to automatically track the Source 1 or Source 2 sweeping parameter (Sweep Track), the measurement of the Frequency counter on the same channel (Counter Tuned), the analog generator (AGen Track), the digital generator (DGen Track), or to be fixed at a user-entered frequency value (Fixed) by the selection of

the BP/BR Filter Freq field. Detector type, reading rate, high-pass filter, low-pass filter, and plug-in option filter may be selected.

### **Function Reading Meter Function THD + N Amplitude**

In the THD+N Amplitude function, the selected channel signal is passed through a tunable bandreject (notch) filter in order to reject the fundamental component of an applied single sinewave test signal before amplitude of the remaining distortion and noise components is measured and displayed. An electronic servo continuously adjusts the filter frequency for maximum rejection of the highest-amplitude frequency component of the signal. The center frequency of the filter may be set anywhere in the range from 10 Hz to approximately 204 kHz. The filter center frequency may be made to automatically track the Source 1 or Source 2 sweeping parameter (Sweep Track), the measurement of the Frequency counter on the same channel (Counter Tuned), the analog generator (AGen Track), the digital generator (DGen Track), or to be fixed at a user-entered frequency value (Fixed) by the selection of the BP/BR Filter Freq field.

The resulting harmonic distortion and noise amplitude measurement is displayed in a selection of absolute units (Volts, dBV, dBu, etc.). This THD+N Amplitude function is particularly useful for measuring distortion during amplitude sweeps. Detector type, reading rate, high-pass filter, low-pass filter, and plug-in option filter may be selected.

### **Function Reading Meter Function THD + N Ratio**

In the THD+N Ratio function, the selected channel signal is passed through a tunable bandreject (notch) filter in order to reject the fundamental component of an applied single sinewave test signal before the amplitude of the remaining distortion and noise components is measured and displayed. An electronic servo continuously adjusts the filter frequency for maximum rejection of the highest-amplitude frequency component of the signal. The center frequency of the filter may be set anywhere in the range from 10 Hz to approximately 204 kHz. The filter center frequency may be made to automatically track the Source 1 or Source 2 sweeping parameter

(Sweep Track), the measurement of the Frequency counter on the same channel (Counter Tuned), the analog generator (AGen Track), the digital generator (DGen Track), or to be fixed at a user-entered frequency value (Fixed) by the selection of the BP/BR Filter Freq field.

The resulting harmonic distortion and noise amplitude measurement is displayed in a selection of relative or ratio units (% , dB, parts per million, X/Y, etc.). The THD+N Ratio function is the most commonly used distortion measurement function, particularly when the signal amplitude is constant as during a frequency sweep. Detector type, reading rate, high-pass filter, low-pass filter, and plug-in option filter may be selected.

### **Function Reading Meter Function SMPTE/DIN (Intermodulation Distortion)**

The IMD analyzer option must be installed for this function to operate. In the SMPTE IMD analysis mode (which also analyzes DIN IMD signals), the expected test signal consists of two sinewaves plus intermodulation distortion products. The lower-frequency sinewave may be anywhere in the range from 40 Hz to 250 Hz. The higher-frequency sinewave may be anywhere in the range from 2 kHz to 100 kHz. The signal is fed through a 2 kHz high-pass filter which strips off the low-frequency tone component of the signal. An amplitude modulation demodulator follows, providing an output amplitude proportional to the sidebands (IMD products) located near the high-frequency “carrier” signal. This signal is further low-pass filtered to remove the “carrier” and is fed on to the bandpass/bandreject (BP/BR) filter block which is not used during SMPTE IMD analysis. The final result is measured and displayed in the Function Meter display field below the channel selection buttons. Only relative units (dB, %, PPM, X/Y) are available in the IMD functions since all IMD standards refer the distortion measurement to the amplitude of one of the signal components. The BW fields (high pass and low pass filter selection) are gray and unavailable in IMD modes since selection of these filters could cause erroneous readings.

## Function Reading Meter Functions CCIF/DFD

The IMD analyzer option must be installed for this function to operate. In the CCIF and DFD (difference frequency distortion) modes, the expected signal consists of two equal-amplitude sinewaves, relatively closely-spaced about a relatively high-frequency center value, plus intermodulation distortion products. Only the low-frequency difference product ( $f_2 - f_1$ ) amplitude is measured by the analyzer. Spacing between the two sinewaves may be anywhere between 80 Hz and 1 kHz. The center frequency value may be anywhere from 3 kHz to 100 kHz. The selected channel signal is fed directly to the 2.45 kHz low-pass filter and 30 Hz high-pass filter and on to the BP/BR filter. The BP filter, in bandpass mode, is automatically tuned to the difference frequency product ( $f_2 - f_1$ ) in CCIF and DFD modes. Thus, other IMD products and wide-band noise are rejected. The result is measured and displayed by the Function Reading meter. Only relative units (dB, %, PPM, X/Y) are available in the IMD functions since all IMD standards refer the distortion measurement to the amplitude of the test signal components. The BW fields (high pass and low pass filter selection) are gray and unavailable in IMD modes since selection of these filters could cause erroneous readings. CCIF and DFD functions differ by a 6.02 dB calibration difference, with the DFD function providing the lower values according to the most recent revision of the IEC-268 specification.

## Function Reading Meter Function DIM/TIM

The IMD analyzer option must be installed for this function to operate. In the DIM/TIM (dynamic intermodulation/transient intermodulation) mode, the expected signal consists of a squarewave at approximately 3 kHz combined with a sinewave at approximately 15 kHz, plus intermodulation distortion products. The selected channel signal is fed directly to the 2.45 kHz low-pass and 400 Hz high-pass filters. The DIM/TIM test signal is constructed so that a fifth order and a sixth order IMD product fall into the spectrum below 2.45 kHz. These are designated u4 and u5 according to IEC 268-3. The 16-pole 2.45 kHz filter rejects the squarewave fundamental but passes the fifth and sixth order products on to the detector. Only relative units (dB, %, PPM, X/Y) are available in the IMD functions since all IMD standards refer the distortion measurement to the amplitude of one of

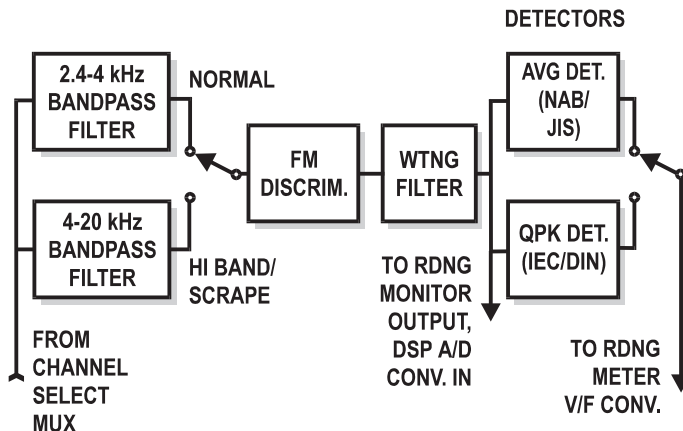

Figure 5-8 Wow and Flutter Analyzer Option, Simplified Diagram

the signal components. The BW fields (high pass and low pass filter selection) are gray and unavailable in IMD modes since selection of these filters could cause erroneous readings.

## Function Reading Meter Function Wow & Flutter Overview

The optional wow and flutter (W&F) analyzer is a circuit board mounted in the lower analog analyzer compartment. Its input signal comes from either channel A or channel B as selected on the Analyzer panel buttons just below the Phase meter. Various standards define test frequency, detector characteristics, and measurement bandwidth. The wow and flutter analyzer meets these standards. See page 5-14 for additional information on standards. For measurements of normal (rotationally-caused) wow and flutter, the signal is passed through a 2-4 kHz bandpass filter that accommodates the standard 3.0 and 3.15 kHz test signals. For measurements of “high band” or “scrape” flutter, a test tone of 12.5 kHz is recommended and the signal is fed through a 4 kHz to 20 kHz bandpass filter. Signal from the selected bandpass filter is fed to a frequency modulation (FM) discriminator. The instantaneous output voltage of the FM discriminator is proportional to the instantaneous peak frequency deviation of the test signal. For weighted wow and flutter measurements, the signal passes through a W&F weighting filter; the filter is bypassed for unweighted

measurements. The final AC wow and flutter signal is fed to the W&F detector and the measured value displayed on the Analyzer panel. A quasi-peak detector is used in IEC (DIN) specified W&F measurements. An average-responding detector is used in NAB and JIS specified W&F measurements, with a longer time constant selected for JIS than for NAB.

### Wow and flutter control

The wow and flutter measurement function is selected as “Wow & Flutter” in the field which selects functions of the Function Reading meter on the Analog Analyzer panel. Two other fields change and two additional fields are “grayed out” when the Wow & Flutter function is selected. The field that normally offers detector choices of RMS, AVG, Q-PK, etc., is replaced with a field offering selection of the three rotational wow and flutter standards IEC, NAB, and JIS. Selecting IEC enables a quasi-peak detector with dynamics (“ballistics”) conforming to the IEC and DIN standards. Selecting NAB or JIS enables an average detector with approximate VU ballistics; JIS also enables a software algorithm that imparts a 4-5 second integration time constant to measurements for a heavily damped response. Measurements may take up to 20 seconds to settle in JIS mode.

The field which normally offers selection among plug-in option filters is replaced with a field which permits selection among weighted or unweighted rotational wow and flutter (3 or 3.15 kHz test tones), weighted or unweighted-high band flutter, wide-high band, or scrape-high band flutter. The latter four choices are normally used with a 12.5 kHz test tone. When Weighted is selected, the weighting filter is inserted between the discriminator and detector stages. When Unweighted selection is made, the measurement bandwidth is flat, extending from approximately 0.5 Hz to 200 Hz.

The four selections ending with “High Band” instruct the analyzer to assume a nominal test tone or “carrier” frequency of 12.5 kHz.

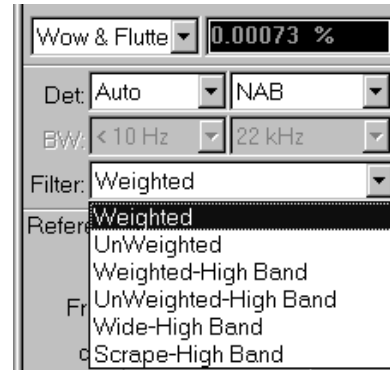

Figure 5-9 Selection Among W&F Standards

**Wide-High Band** selects the full bandwidth of the analyzer, extending from 0.5 Hz to approximately 5 kHz (typically -3 dB at 4.5 kHz). The exact response is significantly influenced by the test tone frequency and has been optimized for 12.5 kHz tones. Lower frequency test tones will exhibit degraded bandwidth and aliasing for FM products above half frequency. The **Scrape-High Band** selection chooses a 200 Hz to 5 kHz analysis bandwidth. **Unweighted-High Band** selects a 0.5 Hz to 200 Hz bandwidth allowing relative comparisons between the scrape flutter and/or servo harmonic products versus rotational products. **Weighted-High Band** selects the same weighting filter used with 3 kHz-3.15 kHz test tones, permitting both weighted wow and flutter and scrape flutter measurements with the same test frequency.

When making wow and flutter measurements, the normal input autoranging feature of the instrument should be disabled. Tapes can exhibit momentary dropouts that might trigger ranging, causing a severe transient in the wow and flutter measurement. Fixing the input range is done with the large version of the Analog Analyzer panel displayed, by un-checking the Auto Range checkbox which corresponds to the input channel in use. Then, enter the maximum expected input level into the field next to the checkbox. The analyzer has been designed to handle signals over a 30 dB window, giving ample margin with a fixed input range.

Wow and flutter measurements are typically observed in real time via a bargraph display or on the Function Reading meter numeric display on the Analog Analyzer panel, or by making a chart-recorder-style “sweep” of wow and flutter versus time. For the time sweep, select Time as the chassis and instrument in the Source-1 Browser. Check the “Show Readings” checkbox, since Time is a reading, and click OK to close the browser. Typical start and stop times might be 5 seconds Start and 25 or 35 seconds Stop. The first five seconds of data is generally not useful since the long time constant detector required for accurate wow measurements will take about five seconds to recover from the initial transient when the wow and flutter option is first enabled by opening a test or changing the Function Reading meter from another function. For this reason, limits for Pass/Fail testing are not normally applied to the first several seconds.

Sweep settling should be turned off (Algorithm None on the Sweep Settling panel) for wow and flutter measurements. The Compute 2-Sigma utility is sometimes used following a wow and flutter versus time measurement to produce the 2-sigma value. See the Compute chapter for more information.

## Wow and flutter theory of operation

Wow and flutter is the undesirable frequency modulation of an audio signal due to instantaneous speed variations caused by mechanical imperfections in a recording and playback mechanism such as a tape recorder or turntable. Wow and flutter measurements are usually made with a test tape or disk having a pre-recorded tone that is assumed to contain very little residual FM. The reproduced tone is bandpass filtered to limit potential wideband interference and is fed into an FM discriminator. The output of the discriminator is an ac signal whose amplitude is proportional to the instantaneous frequency deviation of the test tone. For most measurements this signal is passed, before detection, through a selectable weighting filter whose peak response is centered at about 4 Hz. The purpose of the weighting filter is to produce numerical results that parallel the human ear's sensitivity to different frequency components of wow and flutter. Unweighted measurements simply bypass the weighting filter.

## Measurement Standards

Four major standards exist for the measurement of wow and flutter: IEC, DIN, NAB, and JIS. All recommend the measurement of weighted frequency modulation of a test tone, but differ in specific test tone frequency, detector type, and/or “ballistics” (the dynamic response of the detector). The IEC and DIN standards are identical and recommend a 3.15 kHz test tone with a quasi-peak detection characteristic. Both NAB and JIS recommend a 3.0 kHz test tone but differ in detector type: NAB specifies an average response (RMS calibrated), JIS specifies “effective” response which is similar to NAB detection but with a much longer integration time constant.

The flat or unweighted bandwidth of the NAB and JIS recommendations extends from 0.5 Hz to 200 Hz, covering the portion of the spectrum where frequency modulation is normally caused by



imperfect rotating components such as idlers, wheels, capstans, pulleys, or motors. IEC/DIN recommends a 0.2 Hz lower cutoff; however, little energy is normally present below 0.5 Hz. Because the settling time of a practical 0.2 Hz system cutoff would be 5 to 10 seconds, the low frequency cutoff of the wow and flutter measurement option is designed to be 0.5 Hz regardless of the standard selection. Weighted measurements are not compromised because the weighting filter response includes the effects of the 0.5 Hz low frequency rolloff.

### Scrape flutter theory of operation

Frequency modulation in tape recorders can also be caused by frictional effects of the tape sliding over guides or the tape heads themselves. This form of imperfection is called “scrape” flutter and is characterized by FM products extending to 5 kHz, but often peaking near 3 kHz. Motors with servo speed regulation can also exhibit FM products substantially above the 200 Hz cutoff of normal unweighted wow and flutter measurements. Higher frequency FM products are perceived more as added noise, “grit”, or “harshness” instead of as frequency modulation.

To measure this form of flutter, it is necessary to use a higher test tone or “carrier” frequency to permit FM discrimination of products to 5 kHz without aliasing. To achieve this extended performance, the wow and flutter analyzer utilizes the HIGH BAND flutter measurement technique developed by Dale Manquen of Altair Electronics, Inc. The recommended HIGH BAND test tone frequency of 12.5 kHz yields the desired measurement bandwidth of 5 kHz on recorders that have frequency response to 18 kHz. The wow and flutter option also permits operation at test tone frequencies down to 10 kHz with some increase in alias errors, for recorders such as consumer VCRs that have more limited high-frequency response.

Scrape flutter is normally measured with average detection-RMS calibrated (NAB) characteristics. Measurement bandwidth in HIGH BAND mode is selectable over four bandwidths: 4 Hz bandpass (WTD), 0.5-200 Hz, 200 Hz-5 kHz, and 0.5 Hz-5 kHz. For a typical professional recorder which incorporates a scrape flutter idler, the below-200 Hz and above-200 Hz contributions will be approximately equal.

Despite the difference in test tone frequencies, the conventional and HIGH BAND modes yield near-identical readings if both are weighted or both are unweighted. The only change with the HIGH BAND mode is the extended measurement capability. The HIGH BAND mode can therefore be used for all measurements unless either a pre-recorded 3 or 3.15 kHz test tape is being used, or if the recorder has such limited frequency response that only the lower frequency test tone will pass through the machine.

### **Spectrum analysis of wow and flutter**

With a DSP-based System, FFT spectrum analysis can be performed directly on the 3 kHz or 3.15 kHz tone, or on the wow and flutter discriminator output. Select the FFT spectrum analyzer (fft) DSP program in the Analyzer field at the top of the Digital Analyzer panel. To acquire signal at the discriminator output, select **Low Bandwidth (/4) A/D** as **Input** and **Anlr Rdg Ratio** as **Source** on the Digital Analyzer panel. Choose 16,384 as the Transform Length and a relatively low Internal Sample Rate such as 32 kHz (Rate field in Output section of DIO panel). The actual sample rate at the A/D converter will then be 1/4 the Internal Sample Rate, or 8 kHz in this case. This provides FFT resolution of approximately 0.5 Hz for separation of flutter-frequency components. If the flutter is being caused by defective rotating components, the circumference and diameter of the faulty component may be calculated from the measured flutter frequency and knowledge of the tape speed. For example, a dominant flutter frequency of 7.5 Hz at a tape speed of 7.5 inches per second means that the flutter could be caused by a defective idler or capstan with a circumference of 1.00 inches (diameter of 0.318 inches). This is a powerful diagnostic technique for locating defective rotating components.

### **Function Reading Meter Function 2-Channel Ratio**

In the 2-channel ratio function, the reading meter displays the calculated ratio of the Function Reading meter on the selected channel signal to the Level meter on the opposite meter. The Function Reading meter measurement is influenced by the specific selection of detector, high and low pass filters, and plug-in option filters but the bandpass-bandreject filter is not used. If the two analyzer channels are

connected to the input and output of the device under test, this measurement becomes the voltage gain through the device under test.

## Function Reading Meter Function Crosstalk

In the Crosstalk function, the reading meter displays the calculated ratio of a frequency-selective Function Reading meter measurement on the selected channel signal to the Level meter on the opposite meter. The bandpass filter is engaged in the Function Reading meter in Crosstalk mode, permitting accurate measurements of signals ten to twenty dB below the wide-band noise level. Automatic steering selections of the bandpass filter are as described above in the Bandpass function section. The Function Reading meter measurement is also influenced by the specific selection of detector, high and low pass filters, and plug-in option filters.

## Function Reading Meter Ranging Control and Manual Selection

The Function Reading Meter functional block contains switchable-gain amplifiers with up to 1024x gain, depending upon function and signal level. For most

applications, it is most convenient (and least error-prone) to allow the Function Reading

Meter Autoranging circuitry to select the proper range. Note that Function Reading Meter Autoranging is separate and independent from Input Autoranging. For certain applications where measurements must be made on signals whose amplitude constantly changes, such as tone burst signals or program material, it may be necessary to disable autoranging and manually select a range which will handle the expected peak signal amplitude. When Function Reading Meter Autoranging is selected (Auto box above and to the right of the Function Reading Meter display is checked), the manual range selection field is

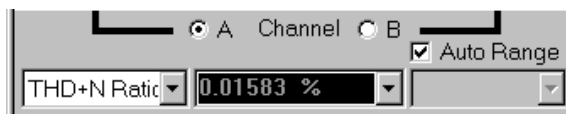

Figure 5-10 Function Reading Meter Auto-ranged

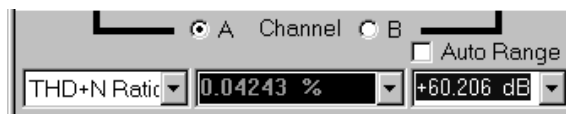



Figure 5-11 Function Reading Meter Range Fixed at User-Entered Gain Value

gray and non-functional. When the Auto box is un-checked to disable autoranging, the range field will display the gain of the range which had been automatically selected. The gain may be expressed in decibels or as a multiplication factor, selectable via the down arrow at the right of the field. A different gain range may be manually selected. The ranges are in 4x (12.04 dB) steps from 1x to 1024x (0.0 dB to 60.21 dB).

To select a new manual gain range, enter the value of gain desired into the range field. A new value may be entered or the present range setting edited from the keyboard after selecting the gain range field. APWIN software will choose the next lowest gain range to avoid overload, and will display the gain range selected when  is pressed after making or editing an entry.

## Detector Reading Rate Control

All six Analog Analyzer meters may make readings at the approximate rates of 4, 8, 16, or 32 readings per second with all versions of analyzer microprocessor (6811) firmware. With the latest revisions of microprocessor code, rates of 64 and 128 readings per second have also been added. Contact Audio Precision or your Audio Precision International Distributor to learn how to obtain revised microprocessor code. Slower reading rates provide more integration of noise and other variations and better resolution, while faster rates provide shorter test times.

Reading rate is normally managed as a function of signal frequency by one of the “Auto” selections in the Reading Rate field. These selections use an APWIN software algorithm to select optimum reading rates as a function of signal frequency. “Auto-Precise” makes reading rate selections more conservatively than the normal “Auto” rate selection, to produce better precision at some cost in sweep speed. “Auto-Fast” (which requires the revised 6811 microprocessor code) makes more aggressive reading rate selections in favor of faster sweeps, at

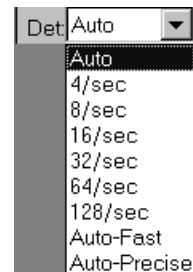

*Figure 5-12 Meter Reading Rate (Integration Time) Control. Level, Frequency, Phase Meters are Controlled Simultaneously by this Field*

some cost in precision. It may be sometimes desirable to force a faster reading rate to obtain greater testing speed at some cost in accuracy, or to force a slower rate to obtain greater resolution at a cost in speed. Generally speaking the 32/second rate will provide full specified accuracy for signal frequencies above 150 Hz, with 16/second valid above 30 Hz, 8/second valid above 20 Hz, and 4/second valid down to 10 Hz. With complex signals, the frequency to be concerned with is the smallest spacing between individual frequency components if that is less than the lowest absolute frequency.

### Detector Control

Five different detector responses are available in the Function Reading Meter: RMS, Average, Peak, Quasi-Peak (Q-Peak), and Sine Scaled Peak (S-Peak). The Level Meter is always RMS responding.

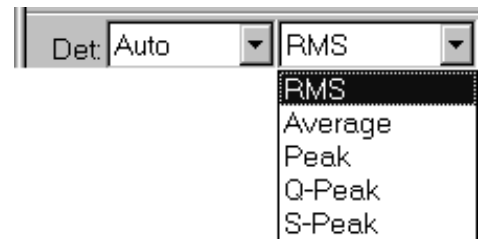

Figure 5-13 Function Reading Meter Detector Response Selection List

### High Pass Filter Control

The Function Reading Meter includes selectable three-pole (18 dB/octave) high-pass filters at turnover frequencies of 22 Hz, 100 Hz, and 400 Hz in addition to flat condition. These filters do not affect any of the other meters.

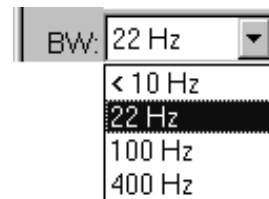

Figure 5-14 Function Reading Meter High Pass Filter Selections

### Low Pass Filter Control

The Function Reading Meter includes selectable three-pole (18 dB/octave) low-pass filters at turnover frequencies of 80 kHz and 30 kHz and a five-pole (30 dB/octave) low-pass at 22 kHz.

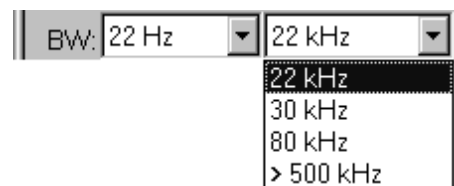





Figure 5-15 Function Reading Meter Low Pass Filter Selections

A flat condition is also available. These filters do not affect the Level Meters.

### Optional Filter Control

The Function Reading Meter includes seven sockets for optional plug-in filters. A kit is available to convert one of these sockets to external BNC connectors for use with an external, user-supplied filter. These filters do not affect the Level Meters or Frequency Counters.

A wide range of weighting, bandwidth-limiting, and bandpass filters are available from Audio Precision to be plugged into those sockets. A filter slot (socket) number may be selected in the list displayed when the down arrow at the right end of the “Filter” control is clicked. If the Auto Detect feature of the Utilities Filter menu command is in use and option filters carrying a 1995 or later copyright date on the circuit board are plugged in, the filter will be automatically detected and its name will be displayed. The Utilities Filter command may also be used to manually specify what filter is plugged into which socket, in case older (pre-1995 copyright) optional filters (which cannot be automatically detected) are used. Filters may then be selected by name instead of slot (socket) number.

If a CCIR weighting filter (FIL-CCR) is used and if it is a 1995 or later filter, it should be automatically detected and its name installed. If not, the Utilities Filters (  ) menu command should be used to designate the “CCIR-468 (33)” selection for whichever socket it is located in. Selecting the “CCIR 468” selection of the Filter control then enables that socket with the proper gain to produce unity gain at 1 kHz as specified in CCIR recommendation 468. The “CCIR-2k” selection of the Filter control also enables the same socket, but with appropriate gain for unity gain at 2 kHz as specified by Dolby for CCIR-ARM measurements (with Average-responding detector).

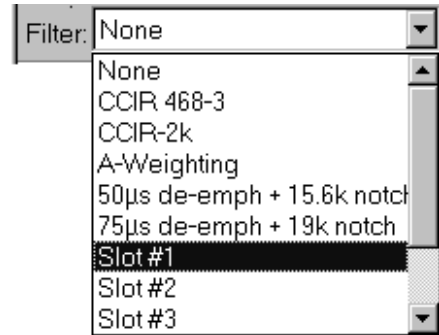



Figure 5-16 Function Reading Meter Plug-in Option Filter Selection List (Typical, Varies with Filters Installed)



## Bandpass-Bandreject Filter Steering Control and Manual Frequency Entry Field

The Function Reading Meter includes a four-pole bandpass or bandreject filter tunable from 10 Hz to 204 kHz. The filter is not used in Amplitude function, 2-Channel functions, and Wow and Flutter function. In the three IMD functions, the filter is configured to improve measurement performance and is not independently steerable. In Bandpass, Bandreject, THD+N, and Crosstalk functions, the filter frequency may be steered in one of five fashions. The filter center frequency is normally automatically steered (Counter Tuned) to the correct frequency for the particular Function Reading Meter measurement function and signal frequency in use, but in some cases may need to be Fixed at a specific value, forced to track the analog generator frequency (AGen Track), forced to track the digital generator frequency (DGen Track), or forced to track the frequency of the device selected at Source 1 or Source 2 on the Sweep panel (Sweep Track). The bandpass filter may also be swept to perform spectrum analysis.

The fixed mode frequency entry field will be gray and non-functional in all steering modes except Fixed. **Fixed mode must be selected if it is desired to sweep the bandpass filter**; the filter tuning will not show up in the Source Browser selections unless “Fixed” has been selected on the analyzer panel. In Fixed steering mode, this field is active and new entries may be made or existing entries edited from the keyboard, in absolute Hz or a variety of relative frequency units referred to the Reference Frequency value at the bottom of the Analog Analyzer panel.

### dBr References

The System Two Cascade analyzer Level and Function Reading Meters have both dBrA and dBrB units available. When dBr units are selected, APWIN software computes the displayed value by use of the dBr Reference values. There are two separate dBr Reference fields labeled dBr A and dBr B and normally used as Channel A and Channel B references. The present signal amplitude on both channels will be automatically entered into the corresponding reference fields when the  function key is pressed. Unless the Function Reading Meter has either the dBrA or dBrB unit selected and one of the Level

meters does not have either dBr unit selected, the measurement from the Channel A Level meter will be written into the dBrA Reference field and the Channel B Level meter reading will be written into the dBrB Reference field when  is pressed. If a dBr unit is selected at the Function Reading Meter and not at the Level Meter monitoring the channel corresponding to the unit selected at the Function Reading Meter, the Function Reading Meter measurement will be written into the dBr Reference field corresponding to the selected unit when  is pressed. The opposite dBr Reference value will be written with the measurement from its corresponding Level meter.

A new dBr Reference value may be entered or the present value edited from the keyboard, followed by pressing the  key.

### **dBm Reference**

---

When dBm units are selected at the Analog Analyzer Level and/or Function Reading Meters, APWIN software converts the actual measured value in Volts to dBm by use of the  $P = \frac{V^2}{R}$  and

$dB = 10 \log \frac{P_{output}}{P_{input}}$  relationships. The value used for R is the circuit

resistance or impedance across which the analyzer input is connected. This is the net parallel value of the analyzer's input impedance with the external circuit impedance. This value must be entered in the dBm Reference field by the user. A new value may be entered or the present value edited from the keyboard, followed by pressing the  key.

### **Watts Reference**

---

When Watts units are selected at the Analog Analyzer Level and/or Function Reading Meters, APWIN software converts the actual measured value in Volts to Watts by use of the  $P = \frac{V^2}{R}$  relationship.

The value used for R is the circuit resistance across which the analyzer input is connected. This is the net parallel value of the analyzer's input impedance with the external circuit resistance. This value must be entered in the Watts Reference field by the user. A new value may be



entered or the present value edited from the keyboard, followed by pressing the  key.

## Frequency Reference

When any relative frequency units (anything other than Hz) are selected at the Analog Analyzer Frequency Counter, APWIN software computes the displayed value by use of the Frequency Reference value. A new Frequency Reference value may be entered or the present value edited from the keyboard, followed by pressing the  key.

## Analog Analyzer Hardware Overview

The analog analyzer consists primarily of two identical input channels and six meters. Each input channel (A and B) has independent peak-sensitive autoranging circuitry and independent control of input impedance. Identical RMS-responding Level meters (Level A and Level B) continuously measure signal amplitudes on the two channels. Identical Frequency meters (A and B) continuously measure signal frequency on each channel. The Phase meter compares the phase of the two input channels, immediately following

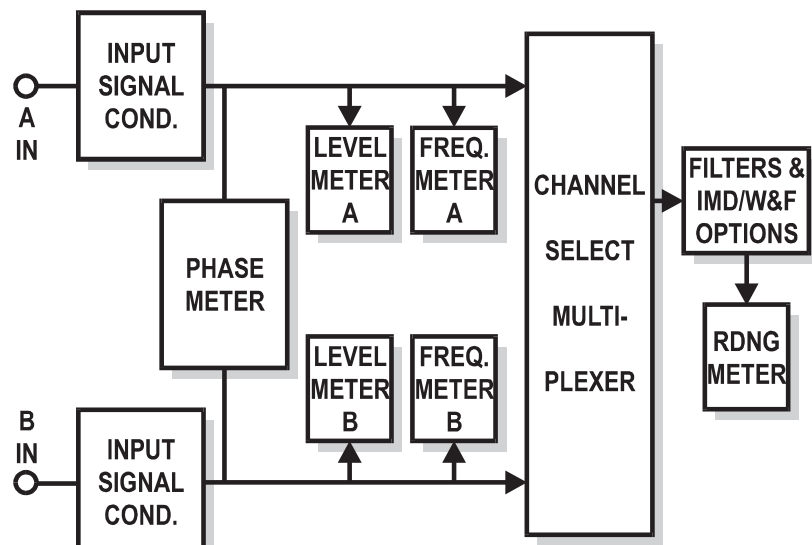

Figure 5-17 System Two Analog Analyzer, Simplified Block Diagram

the input ranging circuitry. The Level meters, Frequency meters, and Phase meter are all single-function meters with relatively little flexibility. A signal multiplexer routes the channel A or B signal to the Function Reading (Rdng) meter. The Function Reading meter is highly flexible, with a selection of high-pass, low-pass, and optional filters selectable, a tunable bandpass/bandreject filter, and additional autoranging gain stages. The Function Reading meter also has a selection of detector responses available. Optional intermodulation distortion (IMD) and wow and flutter (W&F) circuit boards may be added to the analog analyzer. When present, their measurements may be selected as alternate functions of the Function Reading meter.

### Analog analyzer input configuration

Each analog analyzer input channel functionally consists of a balanced high-impedance input, selectable termination resistances, autoranging attenuators and/or gain stages, and balanced-to-unbalanced conversion circuitry. The signal is first presented to AC coupling capacitors (if DC coupling is turned off) and

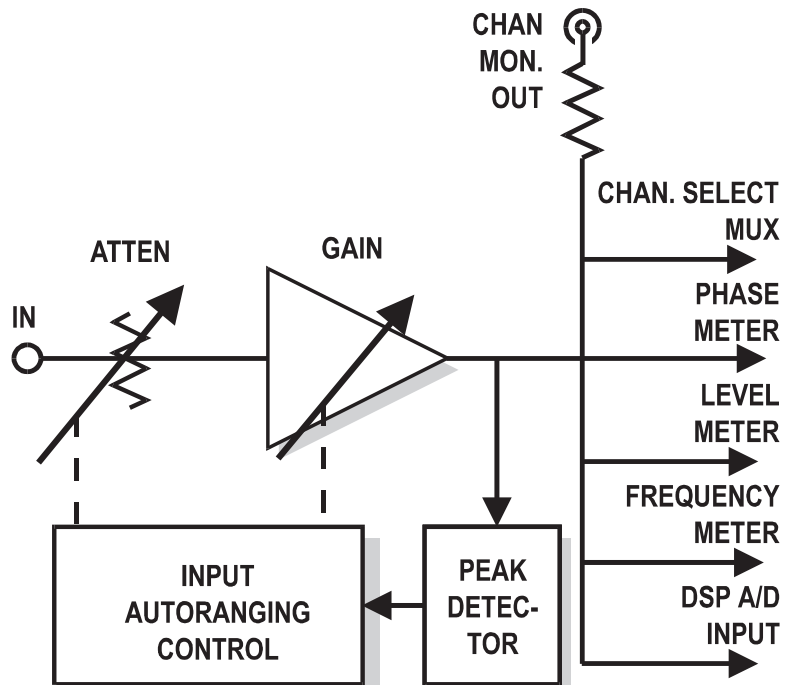

Figure 5-18 System Two Analog Analyzer, Simplified Diagram of Input Channel. Channels A & B Are Identical and Independent

selectable termination impedances. Input termination resistances of either 600 or 300 Ohms may be independently switched across either balanced input, or either input may be operated terminated only by the 100 kilohm input impedance of the first stage. Balanced (differential) switched attenuators and amplifiers follow. The attenuators and amplifiers may be fixed on a specific range but typically operate under control of peak-sensitive autoranging circuits. The autoranging detectors are peak-sensitive and independent between channels. Each channel will select the most sensitive range that will not clip the input signal. The autoranging function (or a fixed range properly selected by the user) assures that the signal amplitude from the conditioning section is optimum for accuracy, resolution, and noise performance of the remainder of the analyzer. Each channel has a generator monitor facility consisting of an internal cable connecting directly to pins 2 and 3 of the corresponding analog generator output connector (A to A, B to B).

## Balanced Inputs

Balanced input is selected by XLR-Bal on the Analog Analyzer panel. Channels A and B are identical as shown. External signals may be furnished to XLR connectors or banana jacks. The XLR

connectors and banana

jacks on each channel are hard-wired in parallel. The plus banana jack connects to pin 2 of the XLR and the minus jack to pin 3. If a 600 or 300 Ohm terminating resistance is selected at the XLR or banana jacks, it continues to load any cable connected to the XLR or banana jacks even if the BNC connector is selected.

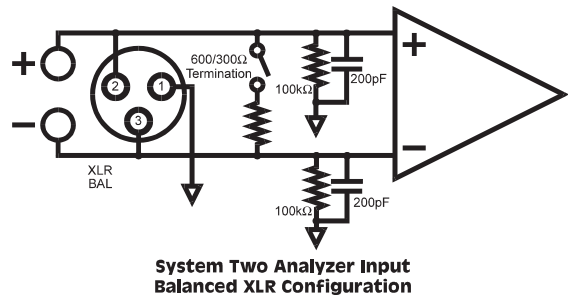
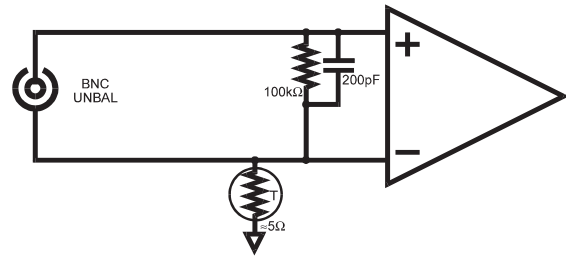

Figure 5-19 System Two Analyzer Equivalent Input Circuit, Balanced XLR

## Unbalanced Inputs

The BNC connectors are always unbalanced (BNC-Unbal Source selection). The shells of the BNC connectors are insulated at the front

panel but connect through a five Ohm PTC (positive temperature coefficient) resistor to chassis ground. The BNC connector input impedance is always 100 kilohms.



**System Two Analyzer Input  
Unbalanced BNC Configuration**

*Figure 5-20 System Two Analyzer Equivalent Input Circuit, Unbalanced BNC*

## Level Meter Hardware

The Level A and Level B meters are single-function, precise true RMS amplitude-measuring instruments. Unlike the Function Reading meter, the Level meters have no selectable filters. The Level meters have a smaller dynamic range than the Function Reading meter, with full specified accuracy and resolution extending down only to five millivolts. The Level meters are useful far below five millivolts, but with deteriorating accuracy and resolution. Bandwidth and frequency response flatness of the Level meters are somewhat superior to those of the Function Reading meter.

## Phase Meter Hardware

The Phase meter is connected across the two input channels of the analog analyzer, immediately following the input autoranging circuitry. The phase meter functions by measuring both the period of the reference channel and the time delay between the signal zero crossing on the selected channel versus the reference channel. Time delay to both positive-going and negative-going zero crossings are measured and averaged to avoid errors when measuring non-time-symmetric signals.

Full specified accuracy for the phase meter requires the signal amplitude on both channels to be above five millivolts.

## Frequency Meter Hardware

The System Two Cascade Frequency meters or counters are a reciprocating, period-averaging design for maximum accuracy and

resolution in a minimum measurement interval at audio frequencies. A period-measuring counter uses the input signal to control a gate into counter registers, with the counter clock (time base) signal flowing through the gate into the registers to be counted when the gate is open. Since quartz crystal clock frequencies are much higher than any audio frequency, a period-measuring architecture always provides better resolution in any given measurement interval than a traditional frequency counter architecture. The final count in the registers represents time per cycle rather than cycles per time, however, so the reciprocal ( $F = 1/T$ ) must be computed in order to display the signal frequency rather than its period. A period-averaging counter adds the feature of automatically maximizing resolution for any permissible measurement interval. The first zero crossing of the signal opens the gate and clock pulses begin to be accumulated in the registers. The gate remains open if the permissible measurement time has not been exceeded at the next zero crossing of the signal. A second counter keeps track of the number of signal cycles during which clock pulses are being accumulated. When the permissible measurement interval is finally reached, the gate is then closed at the next signal zero crossing. The number of pulses in the counter register is then divided by the number of signal cycles for which the gate was open and the reciprocal is calculated.

The minimum signal amplitude for fully-specified operation is five millivolts.

## Function Reading Meter Hardware Overview

The Function Reading meter is the flexible meter in the analog analyzer. In its basic (no options) configuration, it consists of a tunable bandpass/bandreject (BP/BR) filter followed by three selectable fixed low-pass filters, seven sockets for plug-in option filters (or, via adapter kit, six plus an external filter), and three selectable fixed high-pass filters. The filter section output feeds the inputs of the reading meter detectors and the ANALYZER SIGNAL MONITORS READING BNC connector. When the intermodulation distortion (IMD) option is present and an IMD function is selected, the signal is processed through the IMD circuit board before being presented to the BP/BR section input. When the wow and flutter (W&F) option is present, the signal is processed by the W&F circuitry including an extended

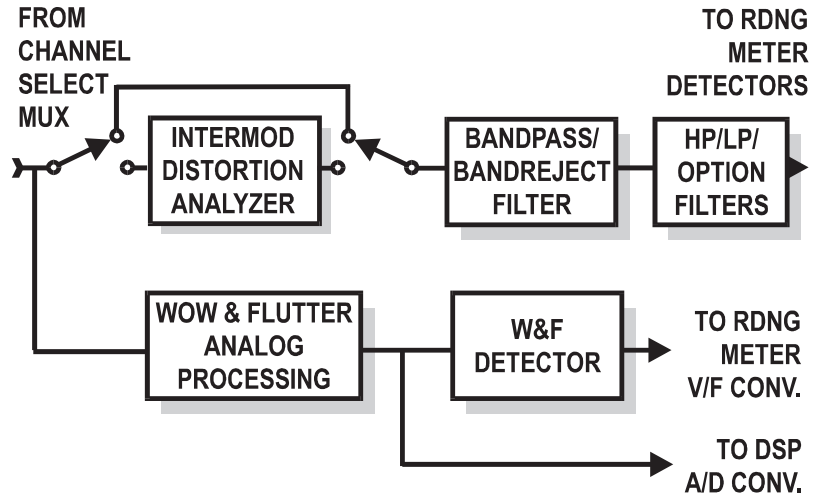

Figure 5-21 System Two Analog Analyzer, Simplified Block Diagram of Function Reading Meter Filters

low-frequency detector on the W&F board, then presented directly to the voltage-to-frequency converter of the Function Reading meter.

### Analog Bandpass/Bandreject Filter Hardware

The Function Reading meter filter section consists of a tunable bandpass/bandreject filter, an autoranging gain stage, and a selection of three each fixed built-in high-pass and low-pass filters plus sockets for optional plug-in filters and provisions for connections to an external, user-furnished filter. The four pole bandreject filter has excellent ability to attenuate a band of frequencies, including close-in sidebands as are caused by flutter, while still attenuating the second harmonic by very small amounts. Maximum performance is obtained in THD+N function rather than Bandreject function of the Function Reading meter, since this engages a servo system that continuously re-tunes the filter for maximum rejection. In Bandreject function, both sections of the filter are nominally tuned to the same frequency but typically attenuate the signal less than in THD+N function due to filter component tolerances. Signal to the fixed filter section passes through the bandpass-bandreject (BP/BR) filter block, whether or not the BP/BR filter is actually selected at the time.

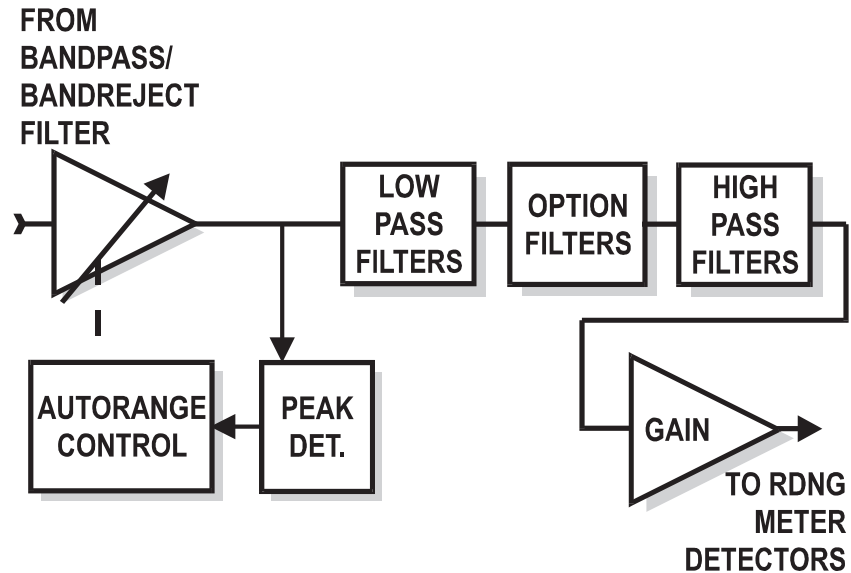

Figure 5-22 System Two Analog Analyzer, Simplified Block Diagram of Fixed Filter Section

Signal amplitude from the BP/BR filter block is adjusted by a switchable gain amplifier before being applied to the fixed filters. The gain of this amplifier is normally controlled by a peak-sensitive autoranging circuit which operates to assure that the signal amplitude is as high as possible for best signal-to-noise ratio while still not overloading the filters and detectors. The autoranging function may be disabled and a fixed gain range selected by the user. The gain range selected when autoranging is determined by signal amplitude before filtering. A high-amplitude signal component at an extreme frequency can cause a low gain range to be selected even though that signal component is then filtered off by one of the following filters. Only one of the high-pass, one of the low-pass, and one of the option filter sockets (or external) may be selected at the same time. The output of the filter section connects to the detector section of the Function Reading meter.

### Function Reading Meter Detector Hardware

The signal output from the reading meter filter section is presented to the inputs of three detectors—true root-mean-square (RMS),

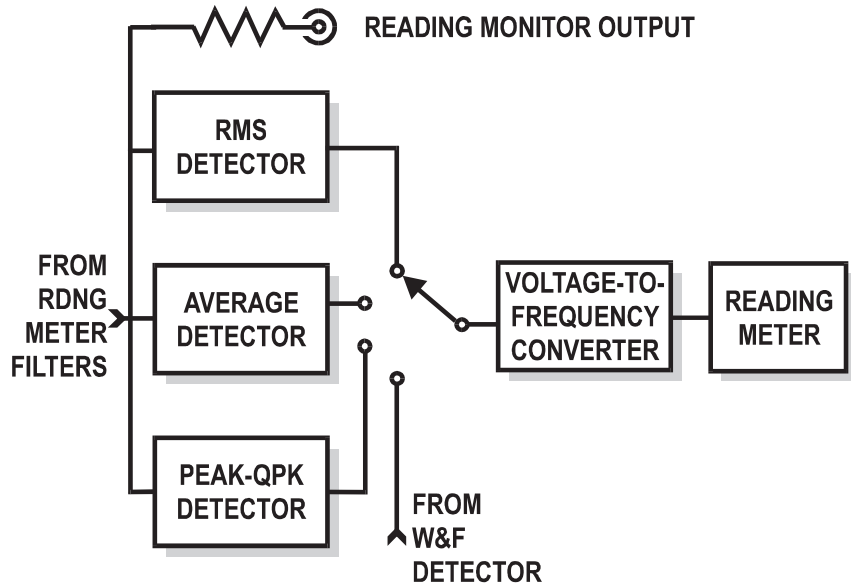

Figure 5-23 System Two Analog Analyzer, Simplified Diagram of Detector Section

average-reading RMS-calibrated (AVG), and the peak/quasi-peak detector (PK /QPK). Each detector produces a DC output amplitude proportional to that parameter of the input AC signal. The DC signal from the selected detector is connected to a voltage-to-frequency (V/F) converter, whose output is a pulse train at a rate proportional to the DC input voltage. The pulse train from the V/F converter feeds a counter. There are three selections of gate time into the counter, nominally 1/32, 1/16, or 1/8 second. At any given pulse rate (corresponding to a DC voltage from the detector), doubling the gate time doubles the number of pulses accumulated into the counter and therefore doubles the resolution of the reading. The value sent from the counter to computer for display or graphing is corrected for the gate time used. Thus, the final value is accurate regardless of gate time, but the resolution of the reading and integration of short-term variations in the signal increase with longer gate times.

Since the W&F option requires response below 1 Hz, a separate detector is incorporated into the W&F circuit board. The output of this W&F detector connects to the V/F (voltage to frequency) converter input for W&F function.



The input signal to the three detectors is the final AC signal in the Function Reading meter. For analog analyzer measurements, this comes from the output of the Function Reading Meter Filters section. It is also fed to the BNC connector labeled ANALYZER SIGNAL MONITORS, READING for oscilloscope monitoring. If DSP modules are present, this same signal is the circuit point available as input to the A/D converters of the DSP module. In W&F function, the READING connector and Function Reading meter selection to the DSP A/D converters are fed from the same signal which drives the W&F detector.

### **Autorange vs. Fixed Range Concepts**

A competent audio analyzer must measure signals across a wide dynamic range. Modern high-powered audio amplifiers produce output voltages on the order of 100 Volts, while output Levels from microphones during acoustic measurements may be hundreds of microvolts or less. No precision Level detector can function accurately across such a high dynamic range. Therefore, an analyzer must contain circuitry to attenuate high Level signals or amplify low Level signals to bring them to the optimum Level for precision detection and indication.

Older audio analyzers and lower-cost instruments use manual range switching. The operator is responsible for selecting an input range that brings the signal into the proper range. Such instruments normally used analog meters, with the proper range selection indicated by the meter pointer being above 1/3 full scale but not beyond full scale. Sophisticated modern analyzers normally manage range selection automatically for maximum accuracy and resolution without operator intervention.

System Two Cascade analyzers have automatic range selection near the inputs and again in the “Function Reading” meter circuitry. Since there are two input channels, the input range selection is duplicated in both channels. See the Analyzer input signal conditioning topic for a block diagram of the analyzer including input ranging; see the Function Reading meter filters topic for a diagram of the Function Reading meter, showing the location of the ranging circuitry there.

In all three locations, the autoranging function is controlled by peak-sensitive detectors so that high crest factor signals will cause the proper range to be chosen. Instruments with RMS or average responding detectors controlling autoranging will select an excessively-sensitive range with high crest factor signals, causing clipping within the instrument with resulting errors.

For certain applications, it is desirable or necessary to fix ranges. Low duty cycle signals, such as a tone burst repeated at the rate of a few bursts per second, will not be reliably measured by autoranging circuits and require the operator to set a fixed range based on a steady sinewave of the same amplitude. Program material such as music and voice cannot be successfully handled by autoranging, so the user must make an independent determination of the expected peak amplitudes and select a fixed range that will handle them. Random noise and certain other signals may have extremely high crest factors which exceed the maximum crest factor rating of the detectors in the autorange circuits, so it may be prudent to fix the analyzer range on the next less-sensitive range above the one chosen automatically. Note that for measurements with the Level meter, Phase meter, Frequency counter, or DSP-based measurements where the signal is obtained immediately following the input ranging circuits, only those input ranges must be fixed. For all measurements made by the Function Reading meter, it may also be necessary to fix the range in the Function Reading meter circuitry.

When a fixed range is selected, it represents an engineering compromise between two problems. If too sensitive a range is chosen, signal peaks may exceed the linear signal-handling capability of the analyzer and clipping with measurement errors will result. If the fixed range is selected too conservatively and the signal varies downwards, increasing measurement errors will result due to the limited dynamic range of the precision detectors in the Level and Function Reading meters. The full dynamic range of these detectors is on the order of 50 dB, with signals more than 50 dB below full scale not being measured at all. The full specified accuracy of the detectors is met over a much narrower dynamic range, with increasing errors resulting from signal Levels more than about 12 dB below full scale.



## DSP Overview

System Two Cascade + DSP versions (SYS-2422) include:

- a main DSP module with multiple processors for analysis and generation of signals
- dual A/D converters to convert analog signals into the digital domain for DSP-implemented analysis
- dual D/A converters that permit DSP-generated signals to be furnished via the analog generator output stage to drive analog devices under test.
- a flexible digital analyzer function, controlled from the Digital Analyzer panel and defined by DSP programs which are automatically downloaded to the DSP module when the analysis program is selected at the top of the Digital Analyzer panel. The useful analysis functions for analog signals include:
  - a DSP-implemented audio analyzer which measures level, frequency, noise, phase, IMD, THD+N, crosstalk, gain, loss, etc, on both channels simultaneously. While somewhat limited in performance and bandwidth relative to the hardware Analog Analyzer, this DSP-implemented program features a number of standard weighting filters, a more-selective tunable bandpass filter, a Fast RMS detector for very rapid sweeps and the ability to simultaneously measure THD+N or IMD on both channels. This analyzer is described in the DSP Audio Analyzer chapter.
  - three FFT-based digital analysis DSP programs. These programs are described in the Spectrum Analyzer, Multitone Analyzer, and Quasi-Anechoic Acoustical Tester chapters.

In addition, System Two Cascade Dual Domain versions (SYS-2522) include:

- a digital input/output (DIO) module with parallel, general-purpose serial, both single and dual connector AES/EBU and Consumer (SPDIF/EIAJ) ports at balanced XLR and unbalanced BNC connectors, and an optical connector. Via the external SIA-2322 Serial Interface Adaptor (optional accessory), the parallel i/o can be converted to a wide variety of serial formats for connection to digital devices at the component and circuit board level.
- digital input selections on the DSP Audio Analyzer and the FFT-based Digital Analyzer programs to permit direct digital domain analysis of incoming digital signals.
- a digital generator that can send a wide variety of waveforms to any of the digital outputs, described in the Digital Generator chapter.
- a digital data analyzer, BITTEST, than can measure bit errors in the digital audio data when using certain compatible signals. See the BITTEST chapter.
- a large selection of measurement capabilities for the AES/EBU/SPDIF/EIAJ serial digital interface signal (pulse train) itself. Some of these measurements are controlled and displayed on the DIO (Digital Input/Output) panel and others are controlled via the INTERVU Digital Analyzer program and displayed as APWIN graphs. These capabilities are primarily described in the Serial Digital Interface chapter.
- a wide variety of simulated impairments which may be added to the AES/EBU/SPDIF/EIAJ serial digital output signal. These impairments are all controlled from the DIO panel and are described in the Serial Digital Interface chapter.
- the ability to synchronize the digital output sample rate to AES/EBU/SPDIF/EIAJ, video, or sinewave/squarewave reference signals, as controlled from the Sync/Ref panel and described primarily in the Sync/Ref chapter.

- display capability for the received status bytes of AES/EBU/SPDIF/EIAJ input signals, independently for the two channels (subframes), in both the high-level English terminology of the standards and as hexadecimal values, and displayed on the Status Bits panel. This capability is described in the Status Bits section (Serial Interface chapter) starting on page 10-46.
- transmission capability for status bytes of those same standards, independently for the two channels, in both high-level English and hexadecimal, controlled from the Status Bits panel and described in the Serial Interface chapter.

## A/D and D/A Converters

All System Two Cascade units except the digital domain-only SYS-2500 include two pairs of A/D converters. Dual 24-bit A/D converters (“HiRes A/D”) provide superior dynamic range at sample rates up to 65 kHz (signal bandwidth about 30 kHz). The HiRes A/Ds may also operate at the OSR (digital Output Sample Rate) set in the Rate field in the Output section of the DIO (Digital Input/Output) panel. Dual 16-bit A/D converters (“HiBW A/D”) operate at faster sample rates to permit analog signals up to about 120 kHz to be measured. These HiBW A/Ds operate at 131.072 kHz, 262.144 kHz, or at twice the OSR. Analog signals to be analyzed are first connected to System Two Cascade’s front panel balanced inputs and gain/attenuator stages before connection to these A/D converters, for convenient operation across a wide dynamic range. The analog analyzer Function Reading meter signal (following all analog hardware processing such as the bandreject filter, wow and flutter discriminator, or IMD detection and filtering) or the recovered jitter signal may also be fed to one of the A/D converters in some analysis programs.

All DSP versions include dual 24-bit D/A converters to provide analog domain output from DSP-generated signals. These D/A output signals are routed through the analog generator amplitude control circuitry, power amplifiers, and output transformers when any of the waveforms containing “(D/A)” are selected on the Analog Generator panel. Generally, the DSP-implemented signals will have slightly higher noise and distortion than analog hardware generated

waveforms, but frequency resolution and stability will be superior and the ability to generate complex signals is much broader via the DSP and D/A converters.

---

## AES/EBU & Consumer interfaces

---

The most popular format for digital audio is commonly called the AES/EBU format and is defined in the AES3 standard published by the Audio Engineering Society. Consumer digital audio equipment commonly is encoded according to standards often called SPDIF (for Sony-Philips Digital Interface) or simply the “Consumer” standard. Defining documents include IEC958 and a document from the EIAJ. The principal differences between the Professional AES/EBU standard and the Consumer standard are in the definitions of the Channel Status Bytes and in the fact that the Consumer standard is often implemented as an unbalanced (coaxial) signal of about one Volt amplitude, where the AES/EBU format is typically a balanced signal on XLR connectors, with about five Volts pk-pk amplitude.

Sample rates of 96 kHz and 88.2 kHz may be implemented as stereo signals on a single connector running at twice normal sample and frame rates. For compatibility with older equipment whose AES/EBU receivers are limited to 48 kHz frame rates, these higher sample rates may also be implemented at the traditional 48 kHz and 44.1 kHz frame rates. This is accomplished by the two sub-frames within each frame carrying successive samples of the same signal, thus providing a sub-frame (sample) rate double the frame rate. Each cable thus carries a monaural signal. Dual connectors are therefore required for stereo signals. System Two Cascade supports both single and dual connector operation at rates to 96 kHz, and dual connector operation only at rates to 176.4 and 192 kHz.





## Digital Domain Testing

System Two Cascade performs testing of digital domain devices without passing signals through A/D or D/A converters. This chapter gives an overview of features related to digital device testing. It describes Digital Input/Output panel features typically involved in testing A/D, D/A, and digital-to-digital devices.

The System Two Cascade Digital Generator generates a wide variety of waveforms directly in the digital domain, to 24-bit performance levels. It is thus suitable for driving digital inputs and D/A converters up to 24 bits of resolution. The Digital Generator is described in the Digital Generator chapter.

Direct digital domain analysis of digital signals is performed by one of several DSP-implemented analyzer programs as summarized later in this chapter and described in detail in individual chapters.

Testing of the serial digital interface signal (pulse train), as opposed to the imbedded audio signal, is described in the Digital Interface Testing chapter.

### Digital Formats

A variety of digital audio formats are in use in various applications and devices. System Two Cascade Dual Domain offers parallel, general-purpose serial, and the AES/EBU and Consumer (EIAJ/SPDIF) formats at balanced (XLR), unbalanced (BNC), and optical (Toslink) connectors. Sample rates of 96 kHz and 88.2 kHz may be implemented as stereo signals on a single connector running at twice normal sample and frame rates. For compatibility with older equipment whose AES/EBU receivers are limited to 48 kHz frame rates, these higher sample rates may also be implemented at the traditional 48 kHz and 44.1 kHz frame rates. This is accomplished by the two sub-frames within each frame carrying successive samples of the same signal, thus providing a sub-frame (sample) rate double the

frame rate. Each cable then carries a monaural signal. Dual connectors are therefore required for stereo signals. System Two Cascade supports both single and dual connector operation at rates to 96 kHz, and dual connector operation only at rates to 176.4 and 192 kHz.

Audio Precision also offers a flexible Serial Interface Adapter (SIA-2322) which converts System Two Cascade's parallel inputs and outputs to a wide variety of proprietary serial formats including Philips I<sup>2</sup>S.

The parallel ports are described in the Parallel/Serial interface chapter, beginning on page 9-1.

## Digital I/O Panel in Digital Domain Testing

Some of the controls and indicators on the Digital Input-Output (DIO) panel relate to both the digital interface pulse train and to its imbedded digital audio signal. Examples are input connector selection. Others are involved only with testing of the Serial Digital

Interface pulse train and are described in the Serial Digital Interface Testing chapter that follows. Still others are directly involved in testing the imbedded digital audio signal. The DIO panel fields related to imbedded digital audio testing are described in the following sections.

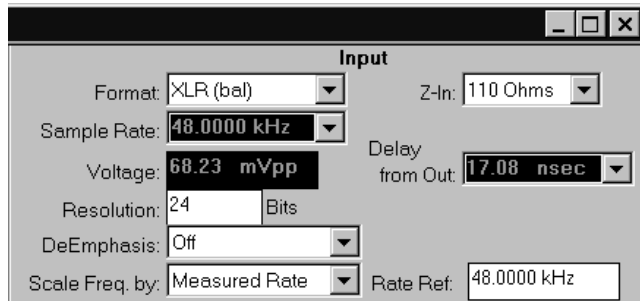

Figure 7-1 Input Controls on Large Version of Digital Input-Output Panel

## Digital Domain Input Signal Selection and Measurement

### Digital Input Connector and Format Selection

System Two Cascade can measure digital input signals from any of several sources including front-panel XLR, BNC, and optical connectors, rear-panel general purpose serial and parallel connectors, and a monitoring path from the internal digital generator. Hardware equalization of the input path may be selected (XLR or BNC connectors only) to compensate for the high-frequency roll-off typical of a long digital interface cable. Selection among these various sources is made in the Input Format field of the DIO (Digital Input Output) panel.

<b>Label</b>	<b>Meaning</b>
XLR (bal)	Front panel XLR digital input connector, balanced
BNC (unbal)	Front panel BNC digital input connector, unbalanced
Optical	Front panel Toslink optical input connector
Gen Mon	Digital generator XLR or BNC output connector
XLR w/Eq	Front panel XLR with equalization for 1000 meter cable roll-off
BNC w/Eq	Front panel BNC with equalization for 1000 meter cable roll-off
XLR Common	Center tap of digital input transformer vs ground
Serial	General-purpose serial capability accessed by certain pins on rear-panel parallel connector
Parallel	Rear-panel parallel input connector
Dual XLR (bal)	Pair of front panel XLR input connectors with each connector carrying a monaural signal whose sub-frame rate is double the frame rate. Left channel is on Connector I and right channel on Connector II
Dual BNC (unbal)	Pair of front panel BNC input connectors with each connector carrying a monaural signal whose sub-frame rate is double the frame rate. Left channel is on Connector I and right channel on Connector II
Dual XLR w/Eq	Same as dual XLR but with equalization for long cables

Dual BNC w/Eq     Same as dual BNC but with equalization for long cables

Note that the digital Gen Mon connection is electrically made to the center conductor of the BNC connector or across pins 2 and 3 or the XLR connector, whichever is selected as the digital output connector on the DIO panel. This point is therefore subject to loading by the input impedance of the device under test. This permits estimates to be made of device digital input impedance by computations from the difference in voltage from an unterminated output connector to the device-terminated condition, using the digital generator output impedance (75 Ohms BNC, 110 Ohms XLR) in the computation. If the front panel XLR or BNC digital output connector is not connected to a load, DIO panel Voltage measurements via the Gen Mon path will give readings approximately double the value set in the Output section since the generator amplitude calibration assumes a matched load.

### Input Resolution (Word Width)

The digital input signal can be truncated at the LSB (least significant bit) of any desired word width (resolution) from 8 to 24 bits before being fed to Digital Analyzer programs for analysis of the imbedded audio. The Active Bits/Data Bits displays on the DIO panel monitor the digital input signal before truncation by the Input Resolution field, so they will indicate the full word width of the external input signal. The value of quantization noise and distortion of the imbedded audio of digital input signals measured by the DSP Audio Analyzer, Spectrum Analyzer, Multitone Audio Analyzer, or Quasi-Anechoic Audio Analyzer programs will be affected by the Input Resolution setting. If the AES/EBU signal being measured uses the Aux bits for another signal, the Input Resolution field must be set to 20 bits (or less) to strip off these Aux bits.

A new input resolution value may be entered or the existing value edited from the keyboard. The Input Resolution may be swept as part of a test by selecting Dio as the instrument and Input Resolution at Source 1 or Source 2 on the Sweep panel.

## Deemphasis

A digital audio signal to be measured may have preemphasis applied. The complementary deemphasis function may be selected in the System Two Cascade digital input to produce overall flat audio frequency response. CD type (50/15 us) or CCITT J17 deemphasis may be selected as desired. Either deemphasis characteristic may be selected with zero dB insertion loss at low frequencies (0 dB selections in each case) or with a gain factor (+10 dB for 50/15us, +20 dB for J17) to compensate for the matching headroom allowances of the System Two Cascade digital generator preemphasis capability. Note that deemphasis, if selected, follows the circuit point where the Peak Monitors are connected. The Peak Monitor display of digital audio signal peak levels is thus unaffected by selection of deemphasis with or without gain.

## Scale Frequency By

The frequency of imbedded digital audio signals must be normalized by a digital sample rate before display, either as a numeric frequency counter display (digital analyzer DSP program) or as a frequency component on an FFT display. Depending on the application, there are several sources of the digital sample rate which may be appropriate to use in the normalization. The “Scale Frequency By” control permits selection of Output Rate, Measured Rate, Status Bits A, or DIO Rate Ref as the sample rate source. Output Rate is the digital generator output sample rate (OSR) set by the Rate field near the top of the Output section of the DIO panel. Measured Rate is the value displayed in the Sample Rate-ISR (input sample rate) field near the top of the Input section of the DIO panel. Status Bits A is the value of sample frequency encoded into the received channel A status bits. DIO Rate Ref is the value entered in Rate Ref field just to the right of the Scale Frequency By field.

Generally, Measured Rate will be used as the scaling source so that imbedded audio signal frequency measurements automatically follow any changes in sample rate from the source. The Output Rate selection can be used to measure the frequency-shifting effects (“Vari-Speed”) of digital processors and sample rate converters. The Status Bits selection refers frequency measurements to the nominal,

standard sample rate (if encoded by the sending device) and will be independent of any moment-to-moment noise and variations in the actual received sample rate. The DIO Rate Ref selection may be used if the measured sample rate is unstable due to high jitter levels or noise.

## Rate Ref

The Rate Ref entry field has two uses, one interface-related and one digital audio-related. For digital audio measurements, this field serves as an absolutely stable value for the nominal input sample rate when DIO Rate Ref is selected in the Scale Freq By field, as described just above. For serial digital interface parameter measurements, the Rate Ref value is the reference for all relative frequency units selectable in the Sample Rate-ISR display field. Thus, if it is desired to display measured sample rate in terms of PPM deviation from the nominal rate, enter the nominal rate into the Rate Ref field and select PPM units for the Sample Rate-ISR display.

## Peak Monitors

The Channel A and Channel B imbedded audio signal peak level may be monitored by the two numeric display fields in the center of the DIO panel. Units may be selected from the usual digital domain unit choices by clicking on the down arrow at the right of either display field and selecting the desired choice. Note that these meters measure the input signal level before application of the selectable deemphasis or deemphasis-with-gain features.

The “Mode” control field to the right of the numeric display fields permits selection among Pos. Peak, Neg. Peak, Abs. Peak, and 1/2 Pk-Pk responses.

The **Pos. Peak** selection causes the Peak Monitors to display the most positive value during each measurement interval, which is

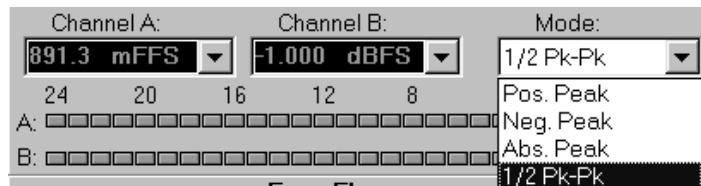

Figure 7-2 DIO Panel Peak Monitors and Mode Selection

approximately 1/4 second.

The **Neg. Peak** selection causes the monitors to display the most negative value during each measurement interval.

The **Abs Peak** selection causes display of the absolute value of the largest positive-going or negative-going value during each measurement interval.

The **1/2 Pk-Pk** selection causes display of the value which is one-half the peak-to-peak range measured during the measurement interval.

### Active Bits Displays

The 24 simulated LED indicators for the received Channel A and Channel B signals indicate bit activity or logic level of the imbedded audio signal. If the Active Bits mode is selected by the “radio buttons” beside these displays, each “LED” will light if the corresponding bit is changing between logical one and zero. Thus, the Active Bits mode indicates that normal data is being transmitted and any indicator that is unlighted indicates either a “stuck bit” or that no signal is being transmitted in that bit. If the Data Bits mode is selected, each “LED” will light if the corresponding bit is a logical one and will not light if the bit is at logical zero. If a stuck bit is indicated in the Active Bits mode, the Data Bits mode can be used to determine whether the bit is stuck high or low.

The left-most indicators (bit 24) correspond to the Most Significant Bit (MSB) of the digital input signal. The professional and consumer standards allow for up to 24-bit wide signals. When less than 24 bits are transmitted, the standards call for the digital audio data to be MSB-justified. Thus, a 20-bit input signal (for example) will light the 20 indicators from 24 through 5, but indicators 4 through 1 will not light since they do not contain changing data.



Figure 7-3 Active Bits/Data Bits Indicators. 16-Bit Imbedded Audio Signal Shown.

## Imbedded Audio Output Features, DIO Panel

### Digital Output Format

System Two Cascade can generate digital domain signals at any of several outputs including front-panel XLR, BNC, and optical connectors, and rear-panel general purpose serial and parallel connectors. Selection among these various outputs is made in the Output Format field.

The available output formats, and their descriptions, are:

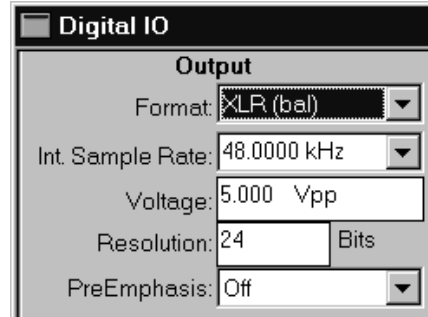

Figure 7-4 Output Control Section, Digital Input-Output Panel

<b>Label</b>	<b>Meaning</b>
XLR (bal)	Front panel XLR digital input connector, balanced
BNC (unbal)	Front panel BNC digital input connector, unbalanced
Optical	Front panel Toslink optical input connector
Serial	Rear-panel general-purpose serial input connector
Parallel	Rear-panel parallel input connector
Dual XLR (bal)	Pair of front panel XLR output connectors with each connector carrying a monaural signal whose sub-frame rate is double the frame rate. Left channel is on Connector I and right channel on Connector II
Dual BNC (unbal)	Pair of front panel BNC output connectors with each connector carrying a monaural signal whose sub-frame rate is double the frame rate. Left channel is on Connector I and right channel on Connector II

### Output Resolution (Word Width)

The width or resolution of the digital output may be set to any value from 8 to 24 bits. Internally, the digital signal is always generated at 24 bits. When any smaller value is selected in the Resolution field, the 24-bit word is rounded (not truncated) to the specified value and lower bits are set to zero. The output resolution is



independent from the input resolution. The output resolution may be swept as part of a test by selecting Dio as the instrument and Output Resolution at Source 1 or Source 2 on the Sweep panel.

## Preemphasis

The digital audio content of the output signal may be preemphasized according to one of two different functions or transmitted without preemphasis. Note that only 50/15 microsecond (CD) preemphasis or no preemphasis are defined conditions under the consumer standard, while the AES/EBU standard additionally defines CCITT J17 preemphasis.

Either preemphasis function may be selected at normal gain or with a headroom allowance. When program material is put through a preemphasis function, the natural high-frequency roll-off of most music and voice signals plus typical practices of headroom allowance for peaks are sufficient to assure that high-frequency signals will not clip (exceed digital full scale). However, full-scale test signals such as sinewave sweeps or multitone signals with equal amplitude at all frequencies will clip at high frequencies. To prevent this clipping due to the high-frequency boost of preemphasis, additional selections are available which attenuate the signal level sufficiently to provide headroom at the highest frequencies. These headroom allowances are selected by the 50/15 us -10 dB and J17 -20 dB choices. Each will attenuate across the spectrum by the specified amount, which is slightly greater than the boost at 1/2 the sample rate for the chosen preemphasis characteristic. If desired, a matching deemphasis and gain selection is available in the Deemphasis field of the Input section of the DIO panel to provide an overall unity gain and flat response.

## Digital Analyzer Panel

System Two Cascade has a dedicated digital analyzer. Several types of analyzers usable with digital domain input signals are furnished with System Two Cascade. Selection among these programs is made in the Analyzer field at the top of the Digital Analyzer panel. The remainder of the Digital Analyzer panel will be blank until a program is selected. The remainder of the panel fields are created

when the specific DSP analyzer function is selected. These analyzer functions are separate and independent from the digital generator, status byte transmission and display, and digital interface stimulus capability of System Two Cascade.

To bring the Digital Analyzer panel to the screen:

Mouse: click on the Digital Analyzer icon  on the Panels Toolbar, or select Panels Digital Analyzer via the menu bar

or

from the keyboard, press    (for Panels digital analyZer)

or

Press  .

The DSP analysis programs useful for digital domain signals are:

- **DSP audio analyzer (ANALYZER).** Measures (on both stereo channels simultaneously) frequency, amplitude, the ratio of amplitudes on the two stereo channels, phase, selective amplitude, crosstalk between channels, THD+N with either ratio units (% and dB) or absolute units, SMPTE/DIN IMD, and noise weighted or unweighted. This program is described in the DSP Audio Analyzer chapter.
- **Spectrum Analyzer (FFT):** Provides general-purpose time domain (oscilloscope) display of waveforms or frequency domain (spectrum analyzer) display of signals. Features include pre-trigger, a variety of selectable transform lengths, the ability to position the start of the transformed section anywhere in the acquired record, synchronous and spectrum averaging, eight windowing functions, and several types of waveform processing for display. This analyzer is described in the Spectrum Analyzer chapter.
- **Multitone Audio Analyzer (FASTTEST):** With multitone test signals, performs post-FFT processing to measure frequency

response, total distortion and noise, noise in the presence of test signal, crosstalk, phase, and generates psychoacoustic masking curves. Trigger modes include external and free-running, or it can be made to trigger only upon receipt of the specific multitone signal stored in the digital generator as a reference. Variable trigger delay may be set to allow audio processors to settle. Frequency error correction compensates for multitone signals coming from other Audio Precision test instruments, played back from digital reproducers with different clock rates, or recorded and reproduced from analog recorders with speed errors up to  $\pm 3\%$ . Multitone Audio Analyzer tests low-bit-rate perceptual coders with multitone signals by summing quantization noise and distortion in critical bands and comparing to an imbedded psychoacoustic model of the frequency masking effect in humans. The Multitone Audio Analyzer is described in a chapter of that name.

- **Quasi-Anechoic Acoustical Tester (MLS):** while normally thought of as an acoustical tester, this program also provides the ability to measure time delay and phase shift through A/D and D/A converters and digital-digital devices in addition to frequency response. It is discussed in the Quasi-Anechoic Tester chapter.
- **Digital Data Analyzer (BITTEST):** in conjunction with certain specific signals created by the digital generator, this program measures the returned digital audio signals for bit errors. This analyzer is described in the Digital Data Analyzer (BITTEST) chapter.



## AES/EBU Interface Testing

System Two Cascade Dual Domain (SYS-2522) and digital-only (SYS-2500) units feature extensive testing of the characteristics of the AES/EBU and Consumer physical interface signal itself—the pulse train which carries the imbedded digital audio signals plus additional synchronization and administrative data. Figure 8-1 is a schematic representation of the measurement capabilities of System Two Cascade for the interface signal. Interface characteristics may be measured and displayed in three different functional areas of the instrument:

- the Digital I/O panel provides selection among five inputs (XLR I and II, BNC I and II, and optical), including selectable termination resistances and selectable input equalization for the XLR and BNC inputs. The DIO panel provides displays for the input signal sample rate, pulse amplitude, jitter, active bits, error flags, and delay of digital input signal from digital output
- the DSP program INTERVU, selectable as one of the analysis functions of the Digital Analyzer panel, operates with a 80 MHz 8-bit A/D converter connected across the serial digital input. INTERVU can provide eye patterns, waveform display and FFT spectrum analysis of the interface signal to a 30 MHz bandwidth, waveform display and FFT spectrum analysis of the recovered jitter signal to a 1.5 MHz bandwidth, provides selectable triggering on both transmitted and received preambles, received channel status block preambles, cell edges, interface error flags, can measure jitter cell by cell, and displays probability histograms of interface signal amplitude, pulse width, and jitter.
- the Spectrum Analyzer (FFT), selectable as an analysis function of the Digital Analyzer panel, can provide waveform display or spectrum analysis to an 120 kHz bandwidth of the recovered jitter signal

In addition to these measurement functions for the serial input signal, System Two Cascade can also simulate impaired interface

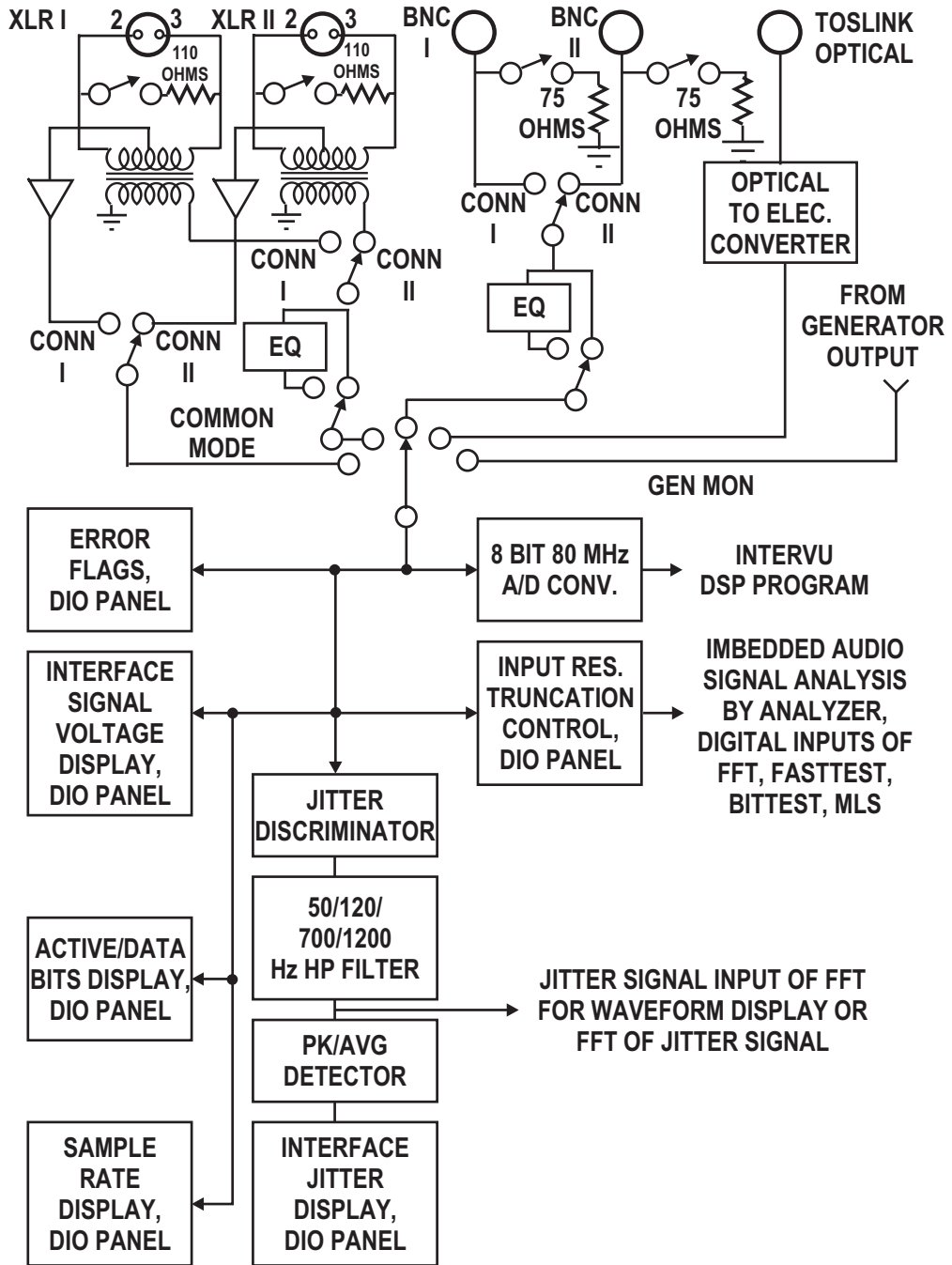

Figure 8-1 Functional Diagram, System Two Cascade Serial Digital Interface Measurement Capabilities

signals at its digital output including variable sample rate, variable output amplitude, variable rise and fall times, simulation of the insertion of a long cable, addition of interfering normal mode noise, addition of common mode sinewaves, and injection of jitter of controllable amplitude with sinewave, squarewave, band-limited noise, and wideband noise waveform. System Two Cascade can also invert the output AES/EBU waveform, can send Invalid flags, and can create deliberate parity errors. All these signal impairment capabilities are controlled from the DIO panel.

System Two Cascade Dual Domain also has extensive synchronization capabilities. The digital output sample rate can be synchronized to the sample rate or frame rate of an AES/EBU or Consumer reference signal connected to the rear panel Ref In XLR connector. The front panel digital output sample, frame, and channel status block are synchronized with the rear-panel AES/EBU Reference Output signal and may be offset in time up to one-half frame from that reference output signal. The output sample rate can be synchronized, at arbitrary rates between 8 kHz and 108 kHz, to the horizontal rate of an NTSC, PAL, or SECAM video signal or to a sinewave or squarewave reference signal between 8 kHz and 10 MHz. The output synchronization capabilities are all controlled from the Sync/Ref panel and described in the Sync/Ref chapter.

## Digital I/O Panel

The AES/EBU and consumer standards are serial data transmission techniques. In normal single connector mode, two audio channels are imbedded as sub-frames into a self-clocking bit stream. In dual connector mode, the two sub-frames carry successive samples of the same signal with Channel A at Connector I and Channel B at Connector II. Measurement of the imbedded audio signals is summarized in the Digital Domain chapter preceding, with details on signal generation and analysis in individual chapters.

In addition to imbedded audio measurements, it is frequently necessary to measure characteristics of the serial bit stream itself. The SYS-2522 and SYS-2500 include the ability to measure the sample rate, pulse amplitude, pulse rise and fall times, jitter amplitude and

spectrum, common mode noise amplitude, delay time from digital generator output to digital analyzer input, delay relative to a reference signal, and to display eye patterns of the digital signal. Some of these measurement functions are displayed on the Digital I/O panel and are thus available at all times, independently of which Digital Analyzer program is in use. Rise and fall time measurements, eye patterns, spectral analysis of the interface signal, and several types of statistical measurements are accomplished with the Digital Interface Analyzer (INTERVU) Digital Analyzer program. Jitter spectrum analysis and waveform display are performed both with the Spectrum Analyzer (FFT) Digital Analyzer program and with INTERVU, with INTERVU providing the wider bandwidth and FFT providing the better frequency resolution. Delay from reference is displayed on the Sync/Ref panel.

To test the tolerance of AES/EBU and consumer digital device inputs, impaired digital output data may be simulated via controlled variation of a number of parameters of the output pulse train including pulse amplitude, rise/fall time, normal mode noise, a long cable simulation, common mode interference, injected jitter amplitude, inversion of the output waveform, setting the Invalid flag, and deliberately creating parity errors, all controlled from the DIO panel. These functions are all available at all times, independent of Digital Analyzer program.

The Digital I/O panel can be brought to the screen by:

clicking on the Digital I/O icon  on the toolbar

or

selecting Panels Digital I/O from the menu bar



or

from the keyboard, pressing    (for Panels digiTal i/o)

or

from the keyboard, typing  



The System Two Cascade DIO Panel may be displayed in small and large sizes. To switch back and forth between large and small sizes, double-click anywhere in the title bar, click on the  icon near the top right corner of the panel, or press the  or  keys.

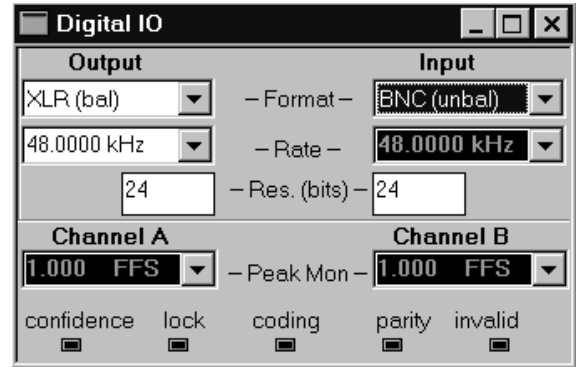

Figure 8-2 Digital I/O Panel, Small Version

## Small Form

The small form of the DIO panel contains only the Input and Output Format, the Output Rate (OSR), and the Input and Output Resolution (word width) control fields plus display fields for the input signal sample rate (ISR), imbedded audio level on both channels A and B, and the invalid, parity, coding, lock, and confidence error flag indicators.

## Input Section, Large Form

The Input section of the large DIO panel includes **control** fields for these serial interface-related features:

- format (connector type, cable equalization off/on, transformer center tap for common mode measurements, digital generator monitor)
- input termination resistance
- Connector I vs Connector II input selection
- Rate Ref field, the frequency reference for the relative frequency units (PPM, etc.) of the sample rate measurement field
- units selection (UI vs. seconds) for jitter

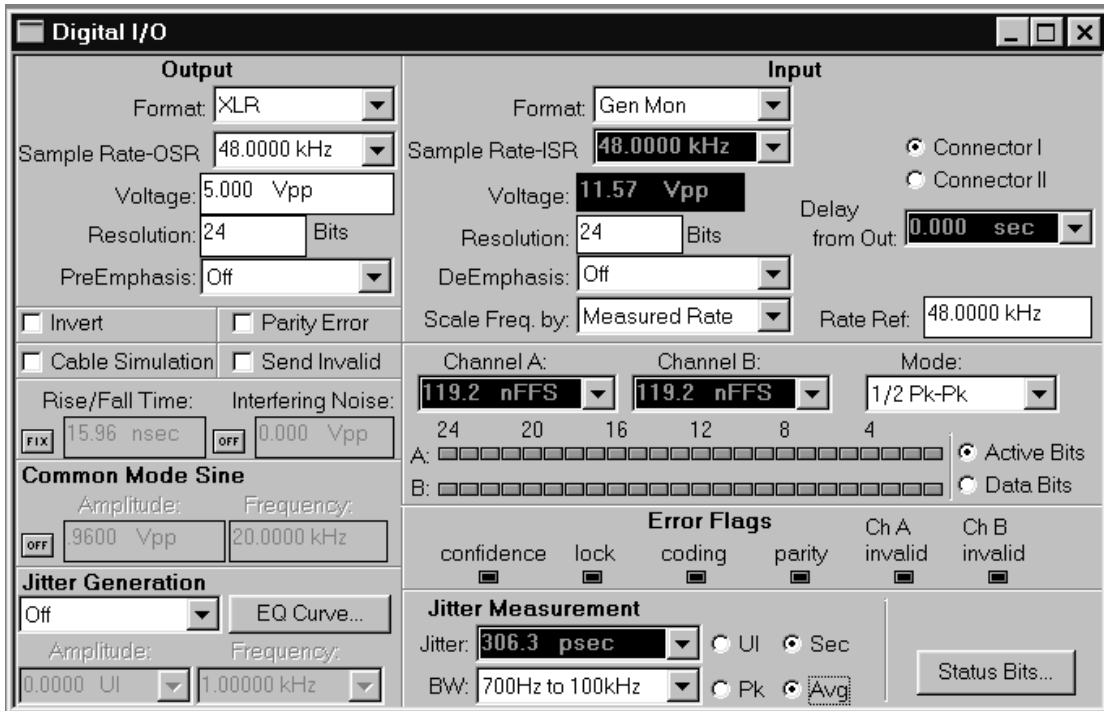

Figure 8-3 System Two Cascade Digital I/O Panel, Large Version

- peak vs. average response and bandwidth control for the jitter meter
  - bandwidth selection for the jitter meter
- and a button to display the Status Bits panel.

The Input section includes **display** fields for these interface parameters:

- input sample rate
- input pulse amplitude
- input signal time delay from digital generator output (propagation delay through digital-to-digital device under test)
- input signal jitter

- interface signal error flags for the invalid bit, parity, coding, lock, and confidence on both channels A and B.

## Digital Input Connector/Format

System Two Cascade can measure the interface characteristics of a serial signal at front-panel XLR, BNC, and optical connectors plus a monitoring path from the internal digital generator. Configurations are available for normal single-connector applications with both stereo channels imbedded into one bitstream, and for dual-connector applications that provide doubled-rate operation with older technology recorders by using one connector for the left channel and the other for the right channel. In this case, the subframes within each frame carry successive samples of the same channel signal rather than alternating stereo channel samples. Hardware equalization of the input path may be selected (XLR or BNC connectors only) to compensate for the high-frequency roll-off typical of a long digital interface cable. The common mode signal between ground and XLR pins 2 and 3 (digital signal input transformer center tap) can be selected in order to measure common mode noise or assess cable imbalance. Selection among these various sources is made in the Input Format field. The table below lists the available selections and their meanings.

<b>Label</b>	<b>Meaning</b>
XLR (bal)	Front panel XLR digital input connector, balanced
BNC (unbal)	Front panel BNC digital input connector, unbalanced
Optical	Front panel Toslink optical input connector
Gen Mon	Digital generator XLR or BNC output connector
XLR w/Eq	Front panel XLR with equalization for 1000 meter cable roll-off
BNC w/Eq	Front panel BNC with equalization for 1000 meter cable roll-off
XLR Common	Center tap of digital input transformer vs. ground
Serial	Rear-panel general-purpose serial input connector
Parallel	Rear-panel parallel input connector
Dual XLR (bal)	Pair of front panel XLR input connectors with each connector carrying a monaural signal whose sub-frame rate is double the frame rate. Left channel is on

Dual BNC (unbal)	Connector I and right channel on Connector II Pair of front panel BNC input connectors with each connector carrying a monaural signal whose sub-frame rate is double the frame rate. Left channel is on Connector I and right channel on Connector II
Dual XLR w/Eq	Same as dual XLR but with equalization for long cables
Dual BNC w/Eq	Same as dual BNC but with equalization for long cables

Note that the digital Gen Mon connection is electrically made to the center conductor of the BNC or across pins 2 and 3 or the XLR, whichever is selected as the digital output connector on the DIO panel. This point is therefore subject to loading by the input impedance of the device under test, and estimates may be made of device digital input impedance by computations from the difference in voltage from an unterminated output connector to the device-terminated condition, using the digital generator output impedance (75 Ohms BNC, 110 Ohms XLR) in the computation. If no load is connected to the front panel XLR or BNC output and voltage is measured via the Gen Mon path, the measured voltage will be approximately twice the programmed output voltage since the generator output amplitude calibration assumes a matched load.

### Rate Reference

---

The entry in this field is the reference for Input Sample Rate measurements in relative units such as PPM (parts per million). Note that this field is also the reference for one of the selections of the Scale Frequency By field and therefore can affect measurements of imbedded digital audio frequency.

### Error Flag Displays

---

The System Two Cascade DIO panel contains four error flag displays for characteristics of the serial digital signal. The flags are labeled Confidence, Lock, Coding, and Parity. Proper operation is indicated when none of the indicators is lighted. When an indicator lights, it is an indication that some characteristics of the digital input signal are marginal or unacceptable.

The **Parity** indicators indicate a parity error in a subframe. Correct parity is determined by comparing the P (parity) bit with the sum of the remaining 31 bits in each subframe. Any single bit error or odd number of bit errors within a subframe that was introduced in transmission will cause a Parity error indication, but even numbers of bit errors cannot be caught by this technique. A deliberate parity bit error can be transmitted from the Output section.

The **Coding** indicators indicate a deviation from proper biphasic coding in the input serial stream (ignoring preambles). Proper biphasic signals can never remain at a logic high or logic low level for more than two consecutive Unit Intervals (UI) except in the preamble. The preamble deliberately deviates from biphasic coding in order to provide a unique frame synchronization signal, and preambles are excluded from the function of the Coding indicators.

The **Lock** indicators light when the digital input phase-locked loop is unable to lock to the incoming signal.

The **Confidence** indicators light when the ratio between the amplitude of the three UI long pulse and the following one UI-long pulse in a preamble becomes large enough to cause an increasing probability of errors when “slicing” the input signal into logic high and low values. This large ratio occurs when the transmission bandwidth has been reduced to marginal or unacceptable values. Under these conditions, selection of hardware input equalization (“XLR with EQ” or “BNC with EQ” rather than “XLR” or “BNC” selections of the Input Format field) will often compensate for the cable bandwidth reduction, cause the Confidence indicator to not light, and provide reliable measurements.

Two additional indicators show whether the Channel A and B “V” bits (data invalid bit) are asserted or not. One Validity bit is sent in each subframe. Exactly how (or if) the Validity bit is set depends upon the design of the particular digital device being measured. For example, a DAT machine may set its V bit to invalid when the tape is not playing and to valid when the tape is moving. Note that it is also possible to control (simultaneously for both subframes) the state of the V bit transmitted by System Two Cascade, via the Send Invalid checkbox in the Output section of the DIO panel.

The INTERVU serial digital interface analysis program can be caused to trigger when any one (or more) of the Parity, Coding, Lock, or Confidence flags is set. INTERVU will then retain in memory approximately 19.66 milliseconds of the digital interface signal preceding the flag. This pre-trigger signal may be analyzed in time or frequency domains to determine what caused the error. For more details, see the INTERVU discussion later in this chapter.

### **AES/EBU/EIAJ Input Termination Resistance**

---

The front panel XLR and BNC digital input connectors for AES/EBU and consumer input signals may be operated as high impedance bridging inputs (approximately 10 kilohms) or resistively terminated. The available termination value for the XLR is 110 Ohms as specified in the AES3 standard; the BNC may be terminated in 75 Ohms. There are no choices for the optical input. The termination condition may be independently selected for the XLR and BNC connectors. The termination selection buttons are displayed only for the connector presently selected, but the termination condition for the unselected connector is also retained.

Note that when Gen Mon is selected in the Format field, no Termination field is displayed. The previously selected terminator remains connected at both XLR and BNC input connectors to avoid changing conditions for the device under test while the Gen Mon path is in use.

### **Input Sample Rate**

---

The digital audio signal sample rate at the digital input connector selected in the Format field is displayed by the Sample Rate display. For single connector AES/EBU and SPDIF/EIAJ operation, the sample rate and frame rate are the same. For dual connector operation, the sample rate (displayed) is actually twice the frame rate since each frame contains two successive samples of the same signal as sub-frames. This sample rate display is also functional when the rear panel general purpose serial or parallel ports are selected. Sample rate may be displayed in Hz, or in relative frequency units where the Rate Ref field is the reference. Sample rate may be plotted on a graph as a function of some swept parameter. On the desired Data browser on

the Sweep panel, select Dio as the instrument and “Input Sample Rate” as the parameter to be plotted.

## Input Voltage

---

The peak-to-peak signal amplitude of the serial pulse train at the front panel XLR or BNC connector selected in the Format field is shown in the Voltage display. The display is not operational when optical or the rear panel general-purpose serial or parallel connectors are selected. If XLR Common is selected in the Format field, the Voltage display shows common mode noise or signal amplitude. Input voltage may also be plotted on a graph as a function of some swept parameter. On the desired Data browser on the Sweep panel, select Dio as the instrument and “Receive Ampl” as the parameter to be plotted.

## Input Delay from Generator Output

---

The time (phase) delay of the selected front panel XLR, BNC, or optical connector with reference to the internal Digital Generator output will be shown in the Delay from Output display. The measurement is thus the propagation delay through a digital device under test. This feature is not relevant with general purpose serial or parallel formats. Delay from generator output may also be plotted on a graph as a function of some swept parameter. On the desired Data browser on the Sweep panel, select Dio as the instrument and “Out to In Delay” as the parameter to be plotted.

## Jitter Measurement

---

The jitter of the selected front panel XLR, BNC, or optical input connector signal is shown in the DIO Panel Interface Jitter display. This measurement is made from the error signal of the AES receiver input phase lock loop and is sensitive to jitter of the total signal, including transitions in the preambles and data sections of the frames. Jitter measurements may be displayed in units of seconds (typically nanoseconds) or UI (Unit Intervals). (Note that jitter may also be measured according to an entirely different technique by the INTERVU digital analyzer program, described later in this chapter.)

Two detector responses, peak and average, are selectable.

**Starting with v1.50a of APWIN software, both detectors are now calibrated in terms of the peak value of a sinewave. Note that this is a change; calibration with v1.40 and earlier software versions was peak-to-peak, so the same jitter signal will now display with half the magnitude that it previously did.**

The average detector is typically used for making frequency response plots of the jitter signal, while the peak detector should be used for characterizing actual interface jitter. Four bandwidth selections (50 Hz-100 kHz, 120 Hz-100 kHz, 700 Hz-100 kHz, and 1200 Hz-100 kHz) may be selected for jitter measurements. Jitter is often dominated by low-frequency noise, so the value of jitter measured is likely to be a strong function of the bandwidth selected. Peak jitter measurements will almost always give a higher number than average, depending upon the crest factor of the jitter waveform.

Jitter may be plotted on a graph as a function of some swept parameter such as time or transmitted jitter amplitude. The FFT Digital Analyzer program may select the Jitter signal and display either jitter waveform or an FFT spectrum analysis of the jitter signal.

## Output Parameters

---

The Output section, occupying the left portion of the DIO panel, selects the interface-related parameters of digital output format and connector and sample rate. Additionally, many types of data impairment may be simulated at the AES/EBU and consumer outputs to test the tolerance and interference rejection capability of digital device inputs.

The output control fields for interface testing are:

- Digital output format
- Output sample rate
- Output voltage
- Phase inversion
- Parity error



- Output cable simulation
- Send invalid
- Output rise/fall time
- Output interfering noise
- Output common mode signal
- Output jitter

## Output Format

---

System Two Cascade can generate digital signals at any of several outputs including front-panel XLR, BNC, and optical connectors, and rear-panel general purpose serial and parallel connectors. Selection among these various sources is made in the Output Format field.

The available output formats, and their descriptions, are:

<b>Label</b>	<b>Meaning</b>
XLR (bal)	Front panel XLR digital input connector, balanced
BNC (unbal)	Front panel BNC digital input connector, unbalanced
Optical	Front panel Toslink optical input connector
Serial	Rear-panel general-purpose serial input connector
Parallel	Rear-panel parallel input connector
Dual XLR (bal)	Pair of front panel XLR output connectors with each connector carrying a monaural signal whose sub-frame rate is double the frame rate. Left channel is on Connector I and right channel on Connector II
Dual BNC (unbal)	Pair of front panel BNC output connectors with each connector carrying a monaural signal whose sub-frame rate is double the frame rate. Left channel is on Connector I and right channel on Connector II

## Output Sample Rate

---

The digital output sample rate (OSR) of System Two Cascade may be freely set across a wide range by keyboard entry of a new value or by editing the present value in the Output Rate field (more fully labeled

as Sample Rate-OSR on the large form of the DIO panel) of the DIO Output section. Note that this rate, labeled OSR, is also available as a sampling rate selection for the A/D converters. The Output Sample Rate may be swept as part of a test by selecting S2 Dio as the instrument and Output Sample Rate at Source 1 or Source 2 on the Sweep panel.

## Output Voltage

The amplitude of the serial pulse train at the XLR and BNC outputs may be varied to simulate cable attenuation. The light intensity at the optical output is also variable. This feature is not available at the general purpose serial or parallel outputs. The output signal amplitude may be swept as part of a test by selecting Dio as the instrument and Output Voltage at Source 1 or Source 2 on the Sweep panel. The XLR, BNC, and optical connectors are all functional whenever any one of these three is selected in the Format field. The actual output voltage/light intensity will correspond to the setting in the Voltage field only at the connector selected in the Format field, with the voltage/light intensity at the other connectors being in error. The amplitude ratio of the XLR connector to the BNC connector is always 5:1. Thus, with the XLR connector selected in Format and 10 Volts set in the Voltage field, the XLR connector will have a 10 Volt pulse amplitude and the BNC will have 2 Volts. If the BNC connector is selected in Format and Voltage is set to 1 Volt, the XLR will have 5 Volts of pulse amplitude. When Optical is selected, the standard light intensity corresponds to a 5 Volt value in the Voltage field.

## Inversion

The polarity of the output AES/EBU bitstream may be inverted by checking the Invert checkbox. Properly-designed AES/EBU receivers should work identically with either polarity of input bitstream.

## Parity Error

The transmitted parity bit in each subframe may be deliberately set to indicate parity errors by checking the Parity Error checkbox.

## Output Rise/Fall Time

The rise and fall times of the pulse train at the XLR and BNC outputs may be varied from 16 to 400 nanoseconds to simulate the bandwidth reduction typical with increasing cable length. This capability is not available at the optical, general purpose serial, or parallel outputs. When the Fix checkbox to the right of the Rise/Fall field is checked, the numeric entry field is gray and not functional and rise and fall times are at their fastest, about 16 nanoseconds. When the Fix box is not checked, new values may be entered into the Rise/Fall field from the keyboard or existing values edited, followed by pressing . The rise/fall time may be swept as part of a test (***if the Rise/Fall Time control on the DIO panel is in the VARIABLE position***) by selecting Dio as the instrument and Rise/Fall Time at Source 1 or Source 2 on the Sweep panel. If the Rise/Fall Time button is set to FIX, the Rise/Fall selection will not appear on the Parameter list in the Browser.

## Output Interfering Noise

To test the noise rejection capability of a digital device's input, interfering random white noise of variable amplitude may be added to the serial pulse train at the BNC connector and added as a Normal Mode signal (between pins 2 and 3) at the XLR connector. This feature is not available at the optical, general purpose serial, or parallel outputs. The maximum amplitude available is 25% of the maximum pulse amplitude at either connector. The Interfering Noise may be turned on and off by the button to the right of the numeric entry field. The Interfering Noise signal amplitude may be swept as part of a test by selecting Dio as the instrument and Noise Amp at Source 1 or Source 2 on the Sweep panel.

## Output Cable Simulation

A fixed hardware filter may be switched into the path to the XLR or BNC output connectors to simulate the effect of a long cable (approximately 1,000 meters) to test the ability of an AES/EBU device input to function with impaired signals. The filter is connected in the circuit when a check mark shows in the Cable Simulation box. This feature is not available at the optical, general purpose serial, or parallel

outputs. This cable simulation is approximately the inverse of the hardware cable equalization function (XLR w/EQ, BNC w/EQ) selectable in the Digital Input Format field, so the two should approximately compensate for one another when a short external cable is connected from Digital Output to Digital Input. However, there will still be an attenuation of the signal introduced by the cable simulation hardware.

## Output Common Mode Signal

---

A sinewave of selectable amplitude and frequency may be added as a Common Mode signal to the XLR output only. The common mode signal amplitude or frequency may be swept as part of a test by selecting DIO as the instrument and Common Mode Ampl or Common Mode Freq at Source 1 or Source 2 on the Sweep panel. The Common Mode Sine button in the Output section of the DIO panel must be ON (lighted green) in order for these Common Mode selections to appear in the Source Browser list. Common Mode signifies that the signal appears between ground and both pins 2 and 3, in-phase at the two pins (injected between center tap and ground of the digital output transformer secondary). The common mode concept is relevant only on balanced transmission lines, so this feature is not available at the BNC, optical, general purpose serial, or parallel outputs. This signal may be used to determine the ability of a digital device's input to reject common mode signals and noise. The Common Mode signal may be turned on and off with the button at the left of the Amplitude field. Amplitude and Frequency of the sinewave are controlled by the Amplitude and Frequency fields.

## Output Jitter

---

Wideband or band-limited random noise jitter, variable-frequency sinewave jitter, or variable-frequency squarewave jitter (all of controllable amplitude) may be added to the digital output signal at the XLR, BNC, and optical outputs to test the ability of a digital device under test to reject input jitter. Controllable output jitter can also be added at the rear-panel MASTER CLK OUT BNC connector, if the "Jitter Clock Outputs" box at the bottom of the Sync/Ref panel is checked. The jitter amplitude may be swept as part of a test (**if the Jitter Type field on the DIO panel is selected as any setting**

**other than OFF**). If the Jitter selection is “Off”, the Jitter Ampl parameter will not appear in the Browser list. Select Dio as the Instrument and Jitter Ampl as the Source 1 or Source 2 setting parameter. Jitter frequency may be swept as part of a test by selecting Dio as the Instrument and Jitter Freq at Source 1 or Source 2 on the Sweep panel.

Amplitude: A new jitter amplitude value may be entered or the existing value edited from the keyboard, followed by pressing .

**Starting with v1.50a of APWIN software, both are now calibrated in terms of the peak value of a sinewave. Note that this is a change; calibration with v1.40 and earlier software versions was peak-to-peak, so the same jitter signal will now display with half the magnitude that it previously did.** Jitter amplitude units available are UI, dBUI (decibels below 1.00 UI), and seconds.

Frequency: A new jitter sinewave or squarewave frequency value or the -3 dB point of the low-pass filter (Lopass Random selection) may be entered or the existing value edited from the keyboard, followed by pressing .

### Equalization of Injected Jitter Amplitude

The sine waveform may be equalized by selecting the EQ Sine setting. Selecting the EQ sine jitter waveform and specifying an equalization curve will cause output jitter amplitude to vary as a function of jitter frequency. A jitter equalization file JITTOL.ADQ is furnished in the directory C:\APWIN\EQ. This file, along with a value of 1.0 UI entered in the Jitter Generation Amplitude field at the bottom left of the DIO panel, will cause jitter amplitude versus jitter frequency to follow a template which is defined in a forthcoming revision of the AES3 specification. A good quality AES/EBU receiving device should function normally at all combinations of jitter frequency and amplitude defined by (below) this template.

## AES/EBU Preambles

The first eight Unit Intervals (UI) of each AES/EBU or SPDIF/EIAJ subframe are called the preamble. Their purpose is for synchronization of a receiver to the incoming signal. Each preamble starts with a 3-UI-wide pulse. This wide pulse violates the bi-phase coding scheme and thus serves as a unique indicator of synch data, impossible to occur anywhere else in the data stream. The AES/EBU standard refers to X, Y, and Z preambles. The SPDIF/EIAJ standards use the terminology M, W, and B for the same three preambles. The X (M) preamble indicates the start of the channel A (left) subframe on 191 of 192 consecutive

occurrences. The Z (B) preamble indicates the start of the channel A (left) subframe on the 1 of 192 occurrences which marks the start of the Channel Status block. The Y (W) preamble always marks the start of the channel B (right) subframe. The figure shows the three

preambles in the case of the first pulse being positive-going. Since these serial transmission standards are not polarity sensitive, the preambles could just as well start with a negative-going pulse.

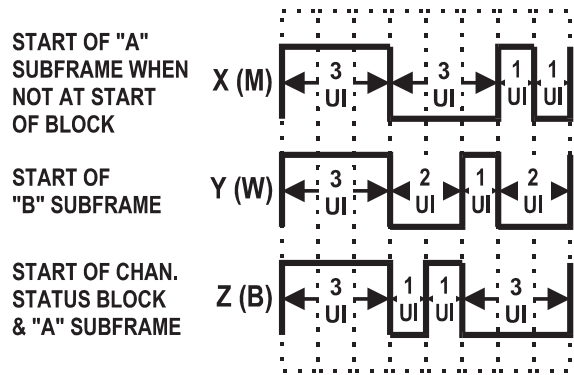

**PREAMBLES (AES/EBU XYZ, CONSUMER MWB)**

*Figure 8-4 Preambles*

## Digital Interface Analyzer

Audio Precision supplies a sophisticated digital signal processing program for System Two Cascade called INTERVU. It supplements the full-time, real-time interface signal measurement capability displayed on the DIO panel with a number of more detailed, sophisticated types of analysis. It operates by digitizing the serial digital interface signal with a dedicated high speed digital oscilloscope inside System Two Cascade. Using complex, proprietary algorithms the software can

determine all critical parameters of the interface. This section begins by describing the basics of making measurements on a digital interface with INTERVU. Later material describes the panel settings and some of the technology involved in the measurements.

INTERVU digitizes the AES/EBU or consumer serial digital interface input signal via an 8-bit A/D converter with an 80.00 MHz sample rate, providing an analysis capability with approximately 25 MHz bandwidth. INTERVU acquires 1,572,864 (1.5M) samples of the interface signal into a buffer, resulting in 19.667 milliseconds of data. Signal acquisition can be triggered by one of several different events on the interface. Once the signal is in memory, any or all of the measurements described below can be obtained. These measurements include oscilloscope and spectrum analyzer type displays of the interface signal or of the jitter on the interface. They may also include histograms of virtually any interface parameter including the interface jitter and eye patterns of the interface signal.

## Getting Started Quickly

Begin by loading the INTERVU program into the Digital Analyzer panel. This panel may be obtained using the “Panels, Digital Analyzer” menu selection or the Digital Analyzer Icon. Next, load the INTERVU program by selecting “Digital Interface Analyzer (intervu)” using the Analyzer field on the Digital Analyzer panel.

Most of the important interaction with the INTERVU program actually takes place on the Sweep panel. This is because its measurements are very graphically oriented. There are no real time readings on the INTERVU panel. The DSP inside the System Two Cascade hardware automatically selects the measurement to be

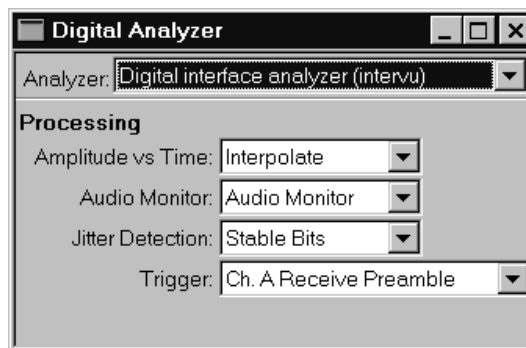

Figure 8-5 Digital Analyzer Panel, Small Version, with INTERVU Loaded

performed based on the choice of Sweep Source and Data on the Sweep Panel. If you want to see an oscilloscope type display of the interface waveform select Intervu.Time as the Sweep Source and Intervu.Amplitude as the Sweep Data 1. Pressing **F9** will then acquire data and display a graph of the interface signal. If you want to see a spectrum analysis of the jitter, select Intervu.Jitter for the Data 1 and Intervu.Freq (Frequency) for the Source. Pressing **F9** will acquire a new set of data and display a graph of the jitter spectrum. If you want to use the same set of data which made the previous graph, simply press **F6**. The DSP will skip the data acquisition and only perform the newly requested measurement on the last acquired data. With the notable exception of Eye Patterns, most INTERVU measurements use only one Data on the Sweep panel.

After making a measurement it may be necessary to change the Data Top and Data Bottom values to better display the data. This can be done with the “Optimize” function, obtained by clicking the right mouse button inside the graph window, or the values may be manually changed on the sweep panel. Alternatively, activating the “Autoscale” check box on the Sweep panel will force the graph axes to expand to prevent any data from plotting off the graph. The horizontal axis may need adjustment to optimally display the data. For example, a sweep from 0 to 20 MHz is quite appropriate for displaying the spectrum of the interface signal. However a jitter spectrum on this same scale would occupy only a fraction of the left side of the graph.

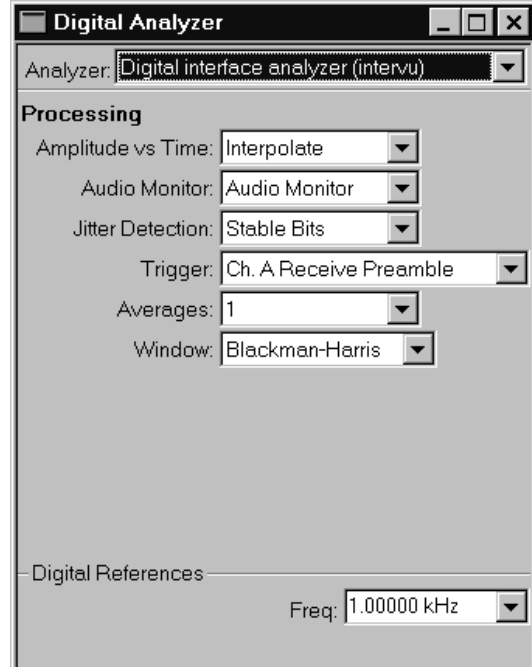

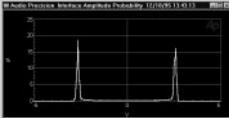
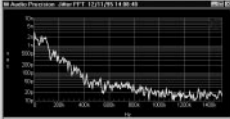
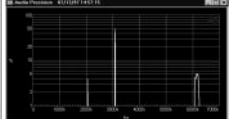
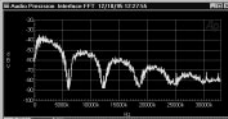
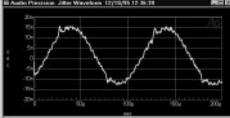
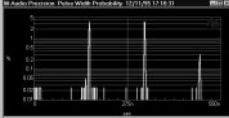

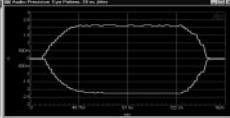
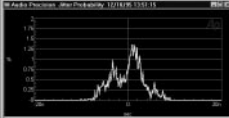

Figure 8-6 Large Version of Digital Analyzer Panel with INTERVU Loaded



Not all combinations of Data readings and Source settings provide useful measurements. The following table shows which combinations are useful and which are not valid. If an invalid combination of Data readings and Source Setting is selected, the software will respond with an error message. However, to avoid receiving an error during setup of the sweep panel, the settings are only checked for conflicts when a sweep is initiated (by pressing one of the  or  key variants). If you receive an error message, select a different combination of readings and settings and repeat the sweep.

Source Selection	Data Reading Section			
	Jitter	Probability	Amplitude	Upper Eye Lower Eye
Amplitude	Not Valid	Interface Amplitude Histogram 	Not Valid	Not Valid
Frequency	Jitter Spectrum 	Interface Rate Histogram 	Interface Spectrum 	Not Valid
Time	Jitter Waveform 	Interface Bit Width Histogram 	Interface Waveform 	Eye Pattern 
Jitter	Not Valid	Jitter Histogram 	Not Valid	Not Valid

NOTE: The Eye Opening selections will not be available in the Browser unless Eye Pattern is selected in the Amplitude vs. Time field on the Digital Analyzer panel. Conversely, if Eye Pattern is selected in the Amplitude vs. Time field, conventional amplitude vs. time displays will not be available.

## Panel Controls

Several fields appear on the Digital Analyzer panel when the Intervu program is loaded.

These control secondary functions such as the choice of windows for FFT processing, the trigger event which will cause an acquisition of data, the source of audio to drive the internal loudspeaker, etc. The only setting that might prevent access to some measurements is the Amplitude vs. Time selection described next below.

### Amplitude vs. Time display processing

Four modes are available in INTERVU for processing the amplitude-versus-time information for display on the graph. Since the high speed digital oscilloscope hardware acquires discrete samples, something must be done to obtain a smooth curve for plotting on the graph. The software allows the choices of:

- Interpolate, which draws smooth curves between the acquired data points
- Display Samples, which displays the data exactly as obtained
- Peak Values, which displays the peak value of the original data points between the last plotted point and the current one.
- Eye Pattern, which overlaps one unit interval long pieces of the acquired data on top of one another

To change modes, click on the down arrow at the end of the Amplitude vs. Time field and click on the desired selection. These modes are applicable to “digital storage oscilloscope” type displays (amplitude versus time graphs), but have no effect on FFT spectrum displays.

When “Interpolate” is selected, the DSP module will perform an interpolation calculation based on the fact that the signal was band-limited by an internal low-pass filter before sampling. This is the appropriate setting for most amplitude vs. time or jitter vs. time plots. It provides a smooth curve indicative of the underlying analog signal

being measured. The filter algorithm used for interpolation requires 7 samples of input signal before displaying an output. This may make the jitter vs. time display show zeros for the first few microseconds. The amount of data zeroed depends on the Jitter Detection selection. Stable Bits will result in half a frame (10  $\mu$ sec at 48 kHz) being zero. All Bits will zero 1/8 of a frame (2.5  $\mu$ sec at 48 kHz) and Preambles will zero 3 1/2 frames (70  $\mu$ sec at 48 kHz). Since jitter is typically plotted over a time scale of several milliseconds this is not typically a problem. However, it may be misleading when initially setting up a jitter vs. time display if the time scale is inadvertently set too short.

When “Display Samples” is selected, no processing takes place in the hardware DSP module. At each time value plotted on the X-axis, the DSP simply sends the amplitude of the nearest-in-time acquired sample of the digital interface waveform to the computer for plotting. This allows you to see the raw data acquired by the DSP, and is useful for understanding how the measurements are made.

When “Peak Values” is selected, the DSP searches all sample amplitudes in the acquisition buffer between the previous point plotted and the current point to be plotted (including the current point but not including the previous point) and sends to the computer for plotting the largest positive or negative value in that span, preserving the plus or minus sign. One intended use of the Peak Values mode is when graphing a relatively long time span on the X-axis, where the combination of Start-to-Stop time span and Steps value on the Sweep panel results in skipping across many actual acquired samples between plotted points. Peak Values mode should also be used when graphing

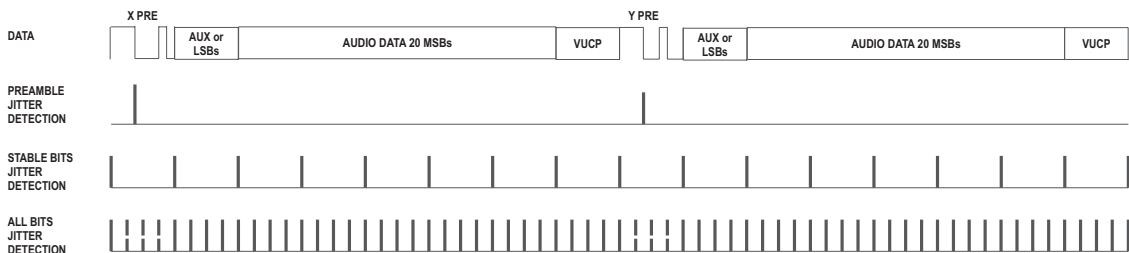

Figure 8-7 Jitter Detection Selections, INTERVU

histograms of Probability vs. Time (Pulse Width) or Amplitude. If Peak Values mode is not used, an unfortunate combination of signal frequency, X-axis span, and Points value can make it appear that no waveform, a near-DC signal, or a waveform at a completely different frequency is present (see the Graphic Aliasing section on page 13-4 of the FFT Based DSP Programs chapter). Since Peak Values searches through all sample values within each span between plotted points and sends the largest value to be plotted, signals cannot be missed.

The “Eye Pattern” selection causes an entirely different sort of processing to take place in the DSP. Following acquisition of the digital interface signal and extraction of an average clock signal from it, the worst-case (nearest to zero Volts) amplitude is determined for each time increment relative to the beginning of each data cell. These values are plotted when Intervu.Upper Eye Opening and Intervu.Lower Eye Opening are selected as Data 1 and Data 2 parameters, resulting in a plot of the worst-case inside of the eye. See the Eye Patterns section for more information and references to an example eye pattern test.

## Jitter Detection

INTERVU is capable of measuring jitter both on AES/EBU signals and on simple squarewave clock signals typically used in A/D and D/A converters. These two modes are described in the following sections

### AES/EBU Jitter Detection

The AES/EBU digital interface encodes two channels of digital audio into a single serial data stream. The serial signal consists of 32 cells (bits) per subframe and two subframes (left and right channels) per frame. The frame rate is equal to the sample rate of the embedded audio. Thus, there are 64 cells (bits) in a complete frame and the cell rate is 1/64 the audio sample rate. The first four cells of each subframe are the preamble. The preamble always starts with a three UI (1 1/2 cell) wide pulse followed by sequences of one UI, two UI, and three UI pulses which are different among the three possible preambles.

An ideal pulse train would have regular transitions at exactly equal intervals corresponding to some “master clock” frequency. Jitter is the

difference in timing of actual transitions of the pulse train from when the transitions should theoretically have occurred. Therefore, jitter measurements require a stable, “perfect” clock signal to use as a reference for comparison of the actual transition times.

INTERVU operates by first acquiring 1.5 Megasamples of the digital interface signal at a sample rate of 80.00 MHz. The contents of the acquisition buffer are then processed in a variety of fashions, depending upon the measurement mode and parameters selected. One portion of the processing involves reconstruction of a “perfect” clock for use as the reference for jitter measurements. The Jitter Detection field on the INTERVU (Digital Analyzer) panel determines at which transitions the clock timing is compared to the interface signal. The available selections are Stable Bits, All Bits, and Preambles. The figure explains the operation of these three selections.

The Preambles selection uses the average rate of the trailing edge of the first three-UI-wide pulse in each preamble as the stable clock reference. Each actual transition at a trailing edge of the first three-UI-wide pulse of each preamble is then compared to that reference (average value) to obtain jitter values for display as jitter waveform, histogram of jitter, or FFT spectrum analysis of jitter. The three-UI pulse in a preamble is the most robust portion of the digital interface signal, since it is least affected by reduced bandwidth in the cable or system. Therefore, jitter measurements made with the Preambles Jitter Detection selection tend to be measurements of the intrinsic jitter in the transmitting device clock and are relatively unaffected by data jitter caused by reduced bandwidth. Since this derived reference clock rate is low (twice the audio frame rate), the effective jitter measurement bandwidth equals the audio frame rate (sample rate) when Preambles is selected.

The Stable Bits selection derives the stable reference clock at 1/4 the actual cell (bit) rate (eight times the audio sample rate), synchronized to the beginning transition of the preamble. As described earlier, the preambles always start with a three UI (1 1/2 cell) wide pulse followed by sequences of one UI, two UI, and three UI pulses that are different among the three possible preambles. There is no cell transition time within the preamble that is common to all three preambles. The highest rate at which transitions can be guaranteed to

occur regularly is at 1/4 the cell rate, which includes the beginning and end of each preamble but no transitions within the preamble. This rate is 16 times the audio sample rate, so the effective jitter measurement bandwidth is eight times the audio sample rate (384 kHz at a 48 kHz sample rate).

The All Bits selection derives the stable reference clock at the actual cell (bit) rate. Since there are 64 cells per frame and the frame rate is the audio sample rate, the reference clock is at 64 times the sample rate and the effective jitter measurement bandwidth is 32 times the audio sample rate (1.536 MHz at a 48 kHz sample rate). Since the preamble of each sub-frame will not have transitions at every cell boundary due to its three-UI-wide pulses (violations of bi-phase coding), the DSP interpolates four transitions across the width of each preamble (shown as dashed lines in the diagram).

The filter algorithm used for the Amplitude vs. Time “Interpolate” setting requires 7 samples of input signal before displaying an output. This may make the jitter vs. time display show zeros for the first few microseconds. The amount of data zeroed depends on the Jitter Detection selection. Stable Bits will result in half a frame (10 µsec at 48 kHz) being zero. All Bits will zero 1/8 of a frame (2.5 µsec at 48 kHz) and Preambles will zero 3½ frames (70 µsec at 48 kHz). Since jitter is typically plotted over a time scale of several milliseconds this is not typically a problem. However, it may be misleading when initially setting up a jitter vs. time display if the time scale is inadvertently set too short.

The All Bits selection in the Jitter Detection field provides the maximum analysis frequency range of approximately 1.5 MHz. If Stable Bits is used, the upper frequency limit is reduced by 4:1, to about 380 kHz. If Preambles is the Jitter Detection setting, the bandwidth is reduced by 32:1 from the All Bits case, resulting in about 48 kHz bandwidth. Stable bits and Preambles will result in the lowest residual measurement jitter. Stable bits will be sensitive to all sources of jitter in a typical system, including jitter induced on an interconnect cable. Preambles will be relatively immune to cable effects and will be dominated by jitter in the source.

## Squarewave (Converter Clock) Jitter Detection

In addition to measuring jitter on an AES/EBU or SPDIF/EIAJ serial digital input signal, INTERVU can also measure jitter on any squarewave up to 13 MHz connected to the BNC (or XLR) digital input connector. This feature permits measurement of jitter directly on the clock signal of A/D and D/A converters. The waveform of the jitter may be displayed (time domain view) or a spectrum analysis of the jitter may be performed (frequency domain view).

The “Jitter Detection” field on the INTERVU panel must be set to either “Squarewave Rising” or “Squarewave Falling” to activate this feature. The “Rising” selection measures jitter on rising edges of the signal and the “Falling” selection measures on falling edges. The first four selections of the “Trigger” field (Ch. A and Ch. B Receive and Transmit) and the “Receive Block” selection all are essentially “free run” selections, acquiring signal as soon as Go is clicked or F9 is pressed. The “Receive Error” selection is not useful when measuring squarewave jitter. The External Pre-Trigger and External Post-Trigger selections operate in conjunction with the “Ext Trigger In” BNC connector on the rear of the DSP module. The External Pre-Trigger selection results in retaining the approximately 19 milliseconds of signal immediately preceding this sample, while the External Post-Trigger selection retains the 19 milliseconds of signal immediately following this sample. The Jitter Generator trigger selection works only when System Two’s Jitter Generator (large form of DIO panel) is turned on. This trigger mode can be useful when looking at jitter on a squarewave clock that is derived from an AES/EBU signal fed from System Two’s digital generator output.

Jitter measures time deviation of zero crossings of a waveform compared to a perfect clock of the same average frequency. For AES/EBU waveforms, System Two determines the average clock frequency by measuring the frame rate of the digital input signal. This frame frequency extraction circuitry is not functional for a squarewave signal, so the DIO panel Sample Rate field is not useful with squarewave input. INTERVU determines average clock frequency to the best of its ability from its acquired signal. Since the acquired signal duration is approximately 19 milliseconds, the resulting frequency measurement is limited in resolution. The result is that a graph of the



jitter waveform of a squarewave input clock, plotted across the 19 millisecond record, may appear as a ramp. The desired jitter signal is the deviation from this ramp. The Compute Linearity function is used to extract variations from an underlying systematic linear variation such as this ramp.

Two standard test setups, one for time domain (waveform) views and one for frequency domain views (spectrum analysis) are furnished in the C:\Apwin\S2\Dig\_I-O directory. The time domain test is named CLOCK JITTER.AT2C. The test is stored with Squarewave Rising as the Jitter Detection choice and can be changed to Squarewave Falling. The test acquires signal from the Digital Input BNC connector, extracts the jitter signal, automatically applies the Compute Linearity function to eliminate the ramp discussed above, and graphs the jitter waveform. The test is set up as a repeating sweep.

The frequency domain test is named CLOCK JITTER FFT.AT2C. It is similar to the time domain test but does not use the Compute Linearity function. It graphs the spectrum of the jitter signal from low frequencies to 1/2 sample rate (24 kHz, presuming a 48 kHz squarewave input signal). At other signal frequencies (clock rates), the Source 1 Stop frequency must be changed to 1/2 the signal frequency.

## Trigger

The acquisition of digital interface signal into INTERVU's acquisition buffer may be triggered at several portions of the serial digital interface pulse train, or by occurrence of an interface Error Flag. The selections in the Trigger field are Channel A Receive Preamble, Channel A Transmit Preamble, Channel B Receive Preamble, Channel B Transmit Preamble, Receive Error, Receive Block, Jitter Generator, External Pre-Trigger, and External Post-Trigger.

The Channel A Receive Preamble selection causes signal to be acquired beginning at the end of the first 3-UI-wide pulse in the Channel A preamble received after Go is clicked or the  function key is pressed. This is known as the X Preamble in the AES/EBU standard and the M Preamble in the Consumer standard. The information displayed will thus be approximately the last four Unit Intervals of the preamble followed by the LSB of the Channel A audio

signal if full 24-bit resolution audio is transmitted, or the beginning of the 4-bit Auxiliary data if audio is restricted to 20 bits or less. The Left channel of stereo material is carried in Channel A. The Channel B Receive Preamble selection similarly triggers at the end of the 3-UI pulse of the first Channel B preamble (Y preamble in AES/EBU terminology, W preamble in the consumer standard).

The Channel A and Channel B Transmit Preamble selections cause signal to be acquired beginning at the start of the first Channel A Preamble or Channel B Preamble transmitted from the System Two Cascade digital output after Go is clicked or the F9 function key is pressed. The entire preamble will thus be visible, followed by data. These selections permit measuring delay through a digital device under test.

The Receive Block selection causes signal to be acquired beginning at the end of the first 3-UI wide pulse of the first Channel Status Block Preamble received after Go is clicked or the  function key is pressed. This is known as the Z Preamble in the AES/EBU standard and the B Preamble in the Consumer standard. The first information displayed will be the last four UIs of the Z preamble, followed by the LSB of the Channel A audio signal if full 24-bit resolution audio is transmitted, or the beginning of the 4-bit Auxiliary data if audio is restricted to 20 bits or less, of the frame which marks the beginning of a new Channel Status Block. Channel Status Blocks are 192 frames long, with the C (Channel Status) bit of each of these 192 frames being assembled into the 24 Channel Status Bytes defined in the AES/EBU and Consumer standards.

The Receive Error selection is a pre-trigger function causing the buffer full of samples immediately preceding an interface Error Flag to be retained. The interface Error Flags are generated by the AES/EBU receiver chip of the DIO. An error status is indicated by lighting the Parity, Coding, Lock, or Confidence indicators at the right of the DIO panel. If this acquisition trigger selection is in use and a Parity error, Coding error, Lock error, or Confidence error occurs, the last (approximately) 19 milliseconds of interface signal preceding the error will be retained in the INTERVU buffer for examination via waveform display, spectrum analysis, or probability histograms. The Invalid

indicator is not considered an interface error and thus will not result in an acquisition into INTERVU.

The Jitter Generator selection causes signal to be acquired synchronous to the start of the jitter waveform. This allows stable time displays of jitter that has been generated originally by the System Two Cascade jitter generator. When testing jitter transfer characteristics of a device by stimulating it with jitter from the System Two Cascade, this setting will produce the most stable measurements. A very useful application of this is measuring the ability of a device under test to track sudden shifts in sample rate. By driving the DUT with a signal having low frequency squarewave jitter (such as 10 Hz) and triggering Intervu from the jitter generator, a time domain display of the step response may be obtained.

The External Pre-Trigger and External Post-Trigger selections are both controlled by an external signal connected to the Ext Trigger In BNC connector on the rear of System Two Cascade Dual Domain. The pre-trigger selection causes the last approximately 19 milliseconds of interface signal preceding the trigger signal to be retained in the buffer, while the post-trigger selection will retain the 19 milliseconds following the trigger.

### **Audible Monitoring of Jitter or Imbedded Audio**

It is often useful to listen to the audio on the digital interface being measured. This can give a quick confidence check that you are measuring the signal you think you are measuring. It can also help in determining if errors being measured correspond to the particular audible defect detected. If jitter problems are suspected in the interface being measured, it may be useful to listen to the jitter itself. This can provide clues to the source of the jitter, and it may help correlate audible distortions with the underlying jitter interference.

The built-in loudspeaker or stereo headphones (plugged into System Two Cascade's front-panel jack) monitor either the imbedded digital audio signal or the demodulated jitter signal. This selection is made using the Audio Monitor field on the INTERVU panel. Selecting Audio Monitor will allow listening to the stereo audio carried on the interface. Selecting Jitter Signal will allow listening to the jitter signal

the analysis hardware detects on the interface. The jitter signal which drives the audio monitor is derived from dedicated hardware and not from the DSP executing the INTERVU program. Consequently, the Interface Jitter bandwidth field on the DIO panel controls the low frequency limit of the audible jitter signal. The upper bandwidth of the audible jitter is limited to approximately 20 kHz, not the 100 kHz of the DIO's real time jitter meter.

As with the audible monitor from other DSP programs, the Headphone/Speaker panel must be set to reproduce audio from the DSP. On the Headphone/Speaker Panel, select Stereo and the DSP Monitor selection or Mono and either DSP Monitor A or DSP Monitor B. When listening to the Audio Signal selection the Stereo Mode will reproduce the two channel audio signal on the interface. Using DSP Monitor A or B will allow selection of either channel individually. When listening to the Jitter Signal either mono or stereo modes may be used, since the jitter signal is mono.

Whether the Headphone/Speaker output is used or not, the two DSP Monitor BNC connectors will carry the selected signals. These may be used to drive external analysis equipment or an external sound reproduction system.

## Windows for FFT Analysis

INTERVU has the several windowing functions available. These are Blackman-Harris, Hann, Flat-Top, Equiripple, and None. The Blackman-Harris window provides a good trade-off between the window's ability to separate closely spaced spectral peaks and its ability to discriminate between moderately spaced spectral peaks that are significantly different in amplitude. There can be as much as 0.8 dB of error in the amplitude measurement, depending on whether the tone being measured is centered in the window. The Flat-Top window provides measurements accurate to a few hundredths of a dB for any spectral peak but sacrifices selectivity for closely spaced tones. Note that the amplitude calibration for FFT spectrum analysis of jitter is in terms of the RMS value of the jitter signal. Thus, a 1 kHz sinewave jitter signal measured at 10 nanoseconds peak on the DIO panel and displayed as a waveform of 20 nanoseconds peak-to-peak in

waveform display mode will have an FFT peak at 1 kHz of about 7 nanoseconds ( $\text{RMS} = 0.707 * \text{peak}$ ).

General purpose spectrum analysis applications, such as displaying the interface signal spectrum, can use the Blackman-Harris window. When making fft based amplitude measurements of a discrete frequency jitter component the Flat-Top window should be used. See the discussion of FFT windows in the FFT-Based DSP Program Chapter for more information on the window shapes and their trade-offs.

## Averages

---

INTERVU allows averaging the results of multiple acquisitions and FFTs in order to reduce the variance of noise and make coherent signals stand out more clearly. The Averages field of the INTERVU panel selects the number of data sets to be averaged. Selections from 2 to 128 are available for averaging. A selection of “1” causes no averaging to take place.

## Digital References

---

The Freq. value serves as the reference for relative frequency units used in the Intervu program. Relative frequency units are ones for which the PC computes a new value from the original frequency value and the reference value. These are useful for displaying the spectra relative to the interface sample rate or relative to the jitter frequency.

There are several choices of relative frequency units in APWIN software, including F/R, dHz, %Hz, octs, decs, d% and dPPM. These are available anytime the Sweep Source parameter is set to Intervu.Freq or one of the Data displays is set to Intervu.Frequency. For a complete discussion of these units and their definition see page 18-6 of this Users Manual.

## Example INTERVU Tests

---

The following sections describe the necessary Sweep panel and Digital Analyzer panel setups for each of the tests that INTERVU can perform. Each refers to an example test furnished with System Two Cascade:

- FFT Spectrum Analysis of Interface Signal
- Waveform Display of Interface Signal
- FFT Spectrum Analysis of Jitter Signal
- Waveform Display of Jitter Signal
- Eye Patterns
- Interface Signal Probability vs. Pulse Width (Histogram)
- Interface Signal Rate Probability (Histogram)
- Interface Signal Probability vs. Amplitude (Histogram)
- Jitter Probability vs. Amplitude (Histogram)

Unless instructed otherwise, the installation software will place these examples in the APWIN\S2CASCADE\PROCEDURES\INTERVU directory. When loading one of these tests, this directory may be found using the browser. All of these tests use the Gen Mon input selection since they demonstrate the measurement of signals generated by the System Two Cascade. To use these samples for actual measurements on a DUT the Input Format on the Digital I/O panel must be changed to XLR, BNC or Optical, as appropriate. Tests similar to many of these designed for actual measurements will be found in the C:\APWIN\S2CASCADE\DIOONLYZR directory.

### FFT Spectrum Analysis of the Interface Signal

INTERVU can display an FFT spectrum analysis of the serial digital interface signal from DC to approximately 30 MHz. INTFCFFT.AT2, supplied with System Two Cascade software, is an example of this capability. Intervu.Freq is selected as Source 1, typically with a Start value of zero Hz and a Stop value of about 30 MHz. Intervu.Amplitude is selected as Data 1, typically using Volts or dBV as the vertical unit. A typical vertical range is from about 100 mV to 100  $\mu$ V (-20 dBV to -80 dBV). The spectrum is typical of a pulse train. The first spectral minimum occurs at a frequency that is the

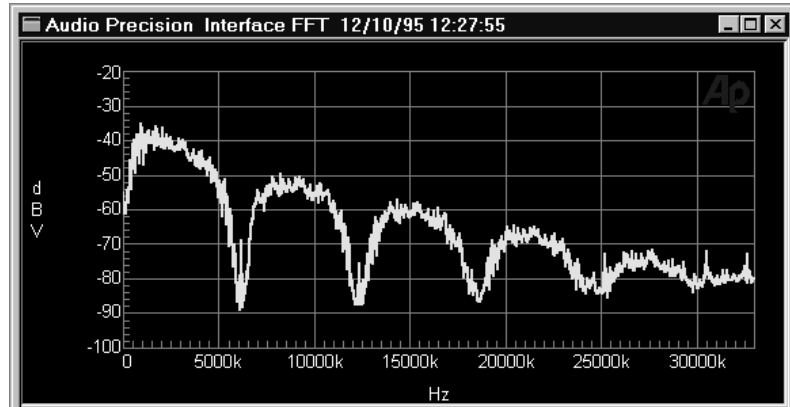

Figure 8-8 FFT Spectrum Analysis of Serial Interface Signal (48 kHz Rate)

reciprocal of one Unit Interval (UI) at the sample rate in use. For example, with a 48 kHz sample rate one UI is approximately 163 nanoseconds and the first spectral null is at about 6.13 MHz.

The interface signal spectrum is particularly useful in showing bandwidth reduction through long or poor digital interface cables, by comparing the spectrum via a short connection with the spectrum through the long cable. The effect of slowed rise and fall times and the cable simulation of the Digital Input-Output panel are also quite evident in a spectrum analysis of the signal. The occupied bandwidth of an externally-furnished digital interface signal can be measured in this mode.

### Waveform Display of the Interface Signal

INTERVU can display the actual interface signal waveform. INTFCWAV . AT2, supplied with System Two Cascade software, is an example of this capability. Intervu.Time is selected as Source 1 while Intervu.Amplitude is selected as Data 1. The acquisition buffer length is 19.66 milliseconds, so any portion of the signal between zero and this value may be viewed except when a Pre-Trigger selection was used to acquire data. If Pre-Trigger is used, the data all precedes the trigger point and thus may be viewed with negative values of Start and Stop time between 19 milliseconds and zero.

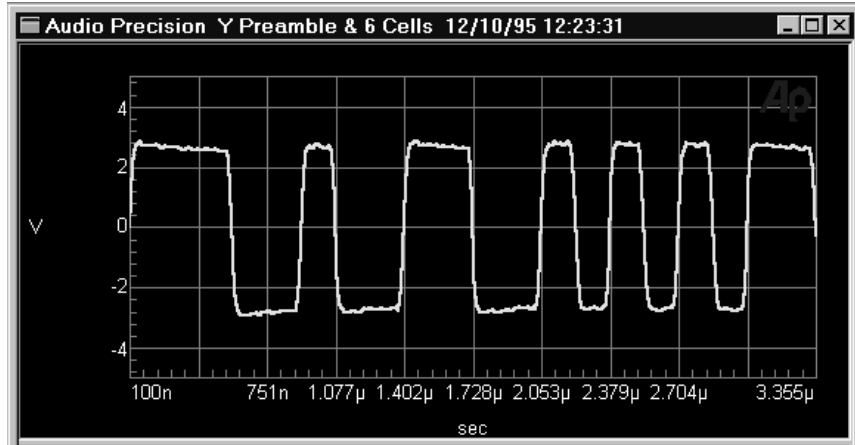

Figure 8-9 Interface Waveform. Y Preamble (3 UI-2 UI-1 UI-2 UI) Followed by Six Data Cells (0,0,1,1,1,0)

The Trigger source selection on the INTERVU panel is important when viewing the interface signal waveform. The Received Preamble and Transmitted Preamble trigger selections cause triggering at the start of a received or transmitted (respectively) subframe. A span between Start and Stop on the order of 100 nanoseconds to a few microseconds permits viewing pulse aberrations and rise and fall times. A span of about 25 or 35 microseconds displays one frame consisting of two subframes, each consisting of a preamble, audio data, and VUCP bits and permits viewing the one UI, two UI, and three UI pulses of the interface. A frame is 20.8 microseconds long at a 48 kHz sample rate and 31.2 microseconds at a 32 kHz rate. Use of a Transmitted Preamble trigger selection permits measurement of time delay through the digital device or system under test. The Receive Block trigger selection triggers at the start of each 192-frame block across which the Channel Status (C) bits are accumulated.

### FFT Spectrum Analysis of the Jitter Signal

INTERVU can perform an FFT spectrum analysis of the jitter signal demodulated from the digital interface input signal. When excessive jitter has been determined to be a problem, spectrum analysis of the jitter signal is a powerful tool in locating the probable source. For example, a strong spectral component near 15.7 kHz can be produced by a video monitor horizontal sweep signal coupling into digital audio



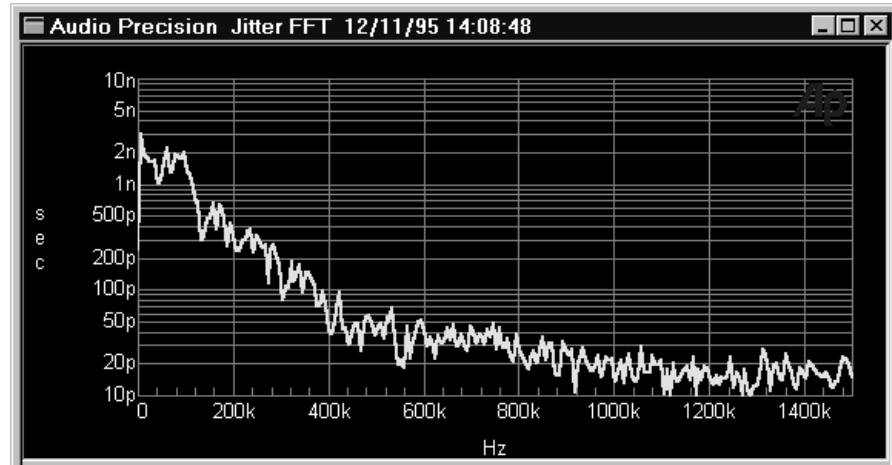

Figure 8-10 FFT Spectrum Analysis of Jitter Signal (100 kHz Lowpass Random Noise from System Two Jitter Generator)

cables and causing jitter. `JITTFFTI . AT2`, supplied with System Two Cascade software, is an example of this capability. `Intervu.Freq` is selected as Source 1. The Start and Stop values can be anything between zero and 1.53 MHz. `Intervu.Jitter` is selected as Data 1. The graph Top value selected depends upon the magnitude of jitter being measured, with values from five to twenty nanoseconds being typical of many devices. Note that calibration is in terms of RMS values, contrasting with the peak values shown on the DIO panel jitter meter and generator.

The All Bits selection in the Jitter Detection field provides the maximum analysis frequency range of approximately 1.5 MHz. If Stable Bits is used, the upper frequency limit is reduced by 4:1, to about 380 kHz. If Preambles is the Jitter Detection setting, the bandwidth is reduced by 32:1 from the All Bits case, resulting in about 48 kHz bandwidth. Stable bits and Preambles will result in the lowest residual measurement jitter. Stable bits will be sensitive to all sources of jitter in a typical system, including jitter induced on an interconnect cable. Preambles will be relatively immune to cable effects and will be dominated by jitter in the source.

When jitter signals below 120 kHz are being studied, use of the FFT digital analyzer program with the Jitter Signal source will provide superior frequency resolution compared to INTERVU. FFT has an

upper frequency limit of at least 120 kHz with the HiBW A/D and at least 30 kHz with the HiRes A/D compared to the 1.5 MHz jitter signal bandwidth of INTERVU with the All Bits jitter detection mode, but far better frequency resolution. Jitter signal selection with FFT is discussed in the FFT-Based DSP Program chapter of the users manual. Jitter frequency components down into picosecond ranges can be resolved by spectrum analysis.

### Waveform Display of the Jitter Signal

INTERVU can display the waveform of the jitter on the digital interface signal connected to System Two Cascade's digital input. When excessive jitter has been determined to be a problem, waveform display of the jitter signal is a powerful tool in locating the probable source. JITTWAVI .AT2, supplied with System Two Cascade software, is an example of this capability. Intervu.Jitter is selected as Data 1. Intervu.Time is selected as Source 1. The Start and Stop values may be set to any values between zero and about 19 milliseconds to best display the jitter signal. If Error Trigger or External Pre-Trigger selections are used the data will be between zero and negative 19 ms.

The graph Top and Bottom values depend upon the magnitude of jitter signal being displayed, with values from five to twenty nanoseconds being typical of many devices. One UI (Unit Interval) of

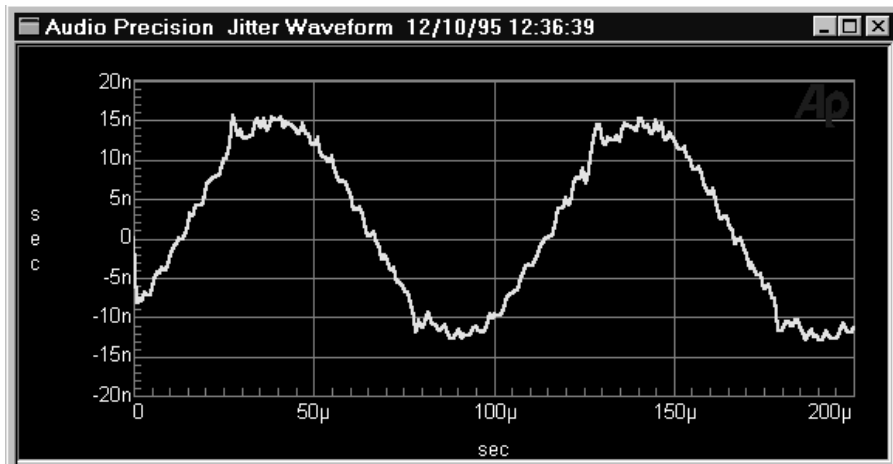

Figure 8-11 Jitter Waveform (10 kHz Sinewave from DIO Jitter Generator)

jitter corresponds to peak values near 200 nanoseconds at the 44.1 kHz and 48 kHz rates. When comparing waveform displays of jitter signals to the DIO panel jitter meter readings, note that with v1.50a and later versions of APWIN, the DIO panel meter is calibrated in peak terms, not peak-to-peak. By selecting a narrow span (a few microseconds) between start and stop times, it is possible to look at the jitter magnitude and polarity cell by cell. In this mode, it is also useful to plot the interface waveform (Intervu.Ampl) as Data 2, in order to see possible relationships between jitter magnitude and the location in the subframe (preamble vs. data).

The filter algorithm used for the Amplitude vs. Time “Interpolate” setting requires 7 samples of input signal before displaying an output. This may make the jitter vs. time display show zeros for the first few microseconds. The amount of data zeroed depends on the Jitter Detection selection. Stable Bits will result in half a frame (10  $\mu$ sec at 48 kHz) being zero. All Bits will zero 1/8 of a frame (2.5  $\mu$ sec at 48 kHz) and Preambles will zero 3 1/2 frames (70  $\mu$ sec at 48 kHz). Since jitter is typically plotted over a time scale of several milliseconds this is not typically a problem. However, it may be misleading when initially setting up a jitter vs. time display if the time scale is inadvertently set too short.

## Eye Patterns

A traditional eye pattern is a time domain (oscilloscope view) of a serial digital signal, usually triggered at the cell rate (every second Unit Interval) of the signal. Eye patterns were originally viewed with analog oscilloscopes. The relatively high trigger rate and the persistence of the oscilloscope CRT resulted in an overlaid view of hundreds or thousands of data cells. Due to the bi-phase nature of the signal, an approximately equal number of positive-going and negative-going transitions are then visible. The appearance of the overlaid patterns is somewhat like an eye if the horizontal time span is about one Unit Interval.

The eye pattern gives a quick view of the quality of a serial digital signal. Normal mode noise on the signal causes vertical expansion of the area covered by successive cells, reducing the height of the opening of the “eye”. Jitter on the signal causes horizontal expansion

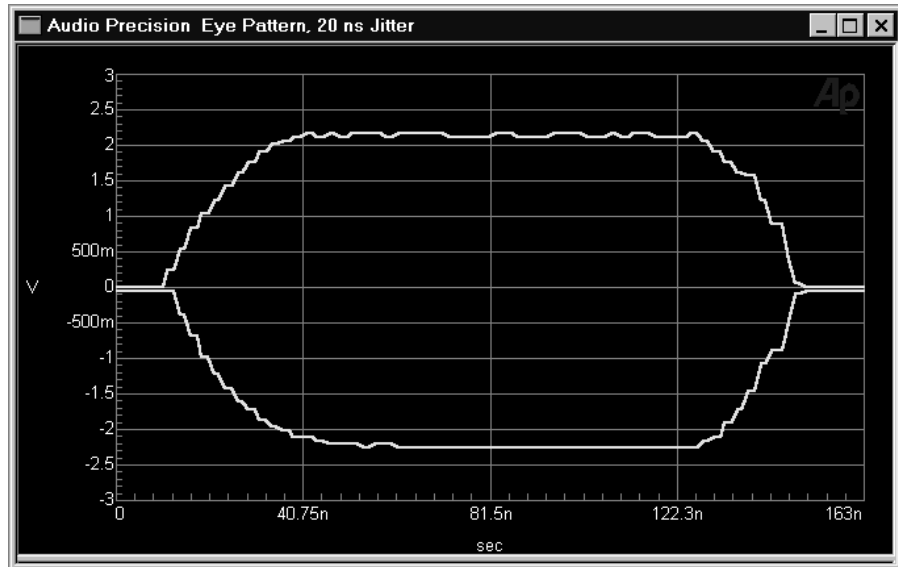

Figure 8-12 Eye Pattern (48 kHz Rate)

of the area covered by successive cells, reducing the width of the eye opening. Smaller eye openings show increased risk that the digital interface receiver will mistake a high voltage for low, or vice-versa, producing errors in the signal. The AES3 specification calls for a minimum eye opening of 200 millivolts vertically by 1/2 UI horizontally.

The INTERVU analysis program and the DSP process a long record of consecutive data cells (about 120,000 Unit Intervals at a 48 kHz sample rate) to produce a graphic display equivalent to the inside of the eye pattern on an analog oscilloscope. `EYEPATRN.AT2`, supplied with System Two Cascade software, is an example of this capability.

In the Amplitude vs. Time field on the Digital Analyzer panel, the Eye Pattern choice is selected. `Intervu.Time` is selected at Source 1, with a Start time of zero and a Stop time of one Unit Interval (about 81 nanoseconds at a 96 kHz sample rate, 162 nanoseconds at 48 kHz, about 177 nanoseconds at 44.1 kHz, about 244 nanoseconds at 32 kHz sample rate). `Intervu.Upper Eye Opening` is selected at Data 1 and `Intervu.Lower Eye Opening` is selected at Data 3. The Eye Opening selections will not be available in the Browser unless Eye Pattern is selected in the Amplitude vs. Time field on the Digital

Analyzer panel. Using Data 3 rather than Data 2 causes both upper and lower opening to be controlled by the Data 1 graph top and bottom selections and the Optimize feature to work properly. Typically, the graph legend is used to select the same color for Data 1 and Data 3, since the two traces together form a complete eye pattern. Acceptance limits may be created for an eye pattern test. 48K-EYE.ADL is furnished as an example limit file for use at the 48 kHz sample rate, using the AES3 specification limits.

Resolution and processing speed for eye patterns are controlled by the Source 1 Steps parameter on the Sweep panel. Fastest operation and the poorest time resolution will result from Steps values up to and including 127. Time resolution is improved 2:1 with Steps values between 128 and 255, but the software will take longer to compute the eye pattern. It is improved 2:1 again with Steps values above 256, at the expense of still slower display updates. Most applications are well served with Steps values of 255.

## Interface Signal Pulse Width Histograms

INTERVU is capable of performing statistical analysis of several characteristics of the digital interface signal and displaying the results in histogram format. WIDTPROB.AT2, supplied with System Two Cascade software, displays the probability of various values of interface signal pulse width. Source 1 is selected as Intervu.Time, with the Start time at zero and the Stop time at a value corresponding to four Unit Intervals. Intervu.Probability is selected as Data 1. A logarithmic vertical scale is useful, with values on the order of 10% for graph Top and 0.01% for graph bottom. The Peak Values mode of Amplitude vs. Time Processing should be used.

With no impairment of the interface signal, the resulting histogram will consist essentially of three vertical spikes at the one UI, two UI, and three UI points on the horizontal axis. The height of each UI spike shows the probability of pulse widths of that value occurring. For typical audio data, the one UI and two UI spikes will be approximately equal, indicating approximately equal numbers of one and two UI-wide pulses (logical ones and zeros in the imbedded audio data). The three UI spike is significantly shorter (lower probability) since pulses of that width occur only in the preamble. Impaired rise and fall

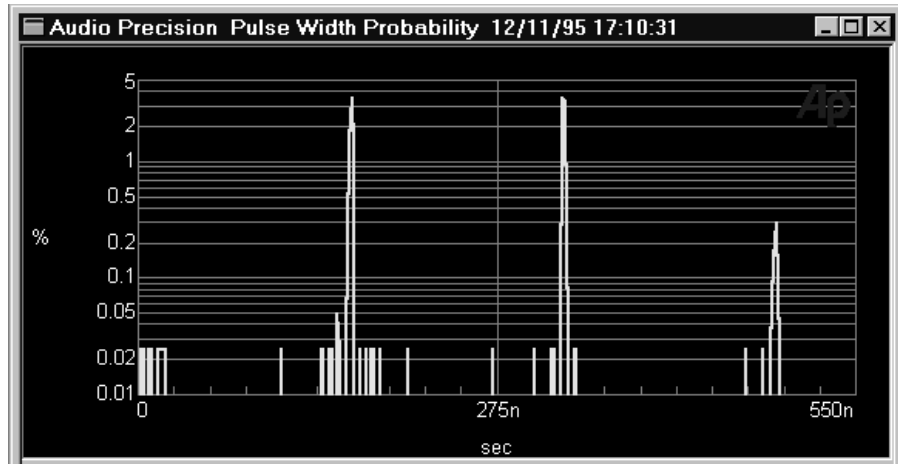

Figure 8-13 Interface Pulse Width (Interface Timing) Probability, 48 kHz Rate

time and/or interfering noise will cause each spike to become wider, at correspondingly lower probability for any specific pulse width value.

The displayed time resolution of the pulse width histogram depends upon the span between the Source 1 Start and Stop values and the Source 1 Steps value. Histograms are computed in the hardware DSP module and divided into 8,192 bins. The accumulated counts across adjacent groups of bins corresponding to the Source 1 step size are then added into “sub-totals”, sent to the host computer, and plotted by APWIN.

### Interface Signal Rate Histograms

INTERVU can “invert” the pulse width histogram described above to obtain a “bit-rate” histogram. `RATEPROB.AT2`, supplied with System Two Cascade software, displays the probability of occurrence of the various instantaneous frequency values of the interface waveform. The time between each successive pair of zero crossings of the interface signal is measured and these times are sorted into bins depending upon their value. `RATEPROB.AT2` shows three “spikes”, corresponding to the frequency equivalents of the three UI, two UI, and one UI pulses that make up the signal. At a 48 kHz sample rate, the three UI pulses are equivalent to a frequency of about 2.07 MHz, the two UI pulses correspond to a frequency of about 3.10 MHz, and

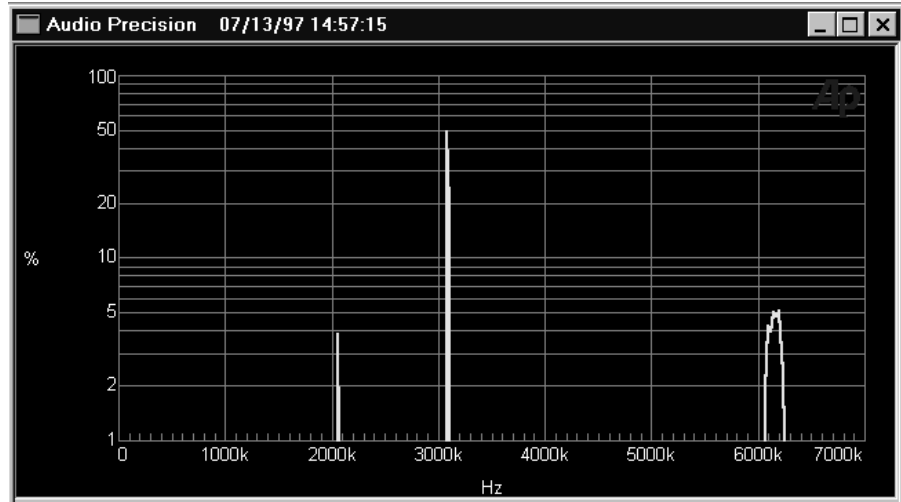

Figure 8-14 Interface Rate Probability, 48 kHz Rate

the one UI pulses are equivalent to a frequency of about 6.16 MHz. Jitter will spread each spike across the nearby spectrum.

### Interface Signal Amplitude Histogram

When characterizing the squareness of a digital signal it is often convenient to view a histogram of the signal amplitude. `AMPLPROB.AT2`, supplied with System Two Cascade software, is an example. Source 1 is selected as `Intervu.Ampl`, with a negative Start value somewhat greater than the maximum expected signal negative peak value and a symmetrical positive value for the Stop amplitude. `Intervu.Probability` is selected as `Data 1`. A graph Top value of about 20% and Bottom value of zero with a linear scale is generally useful.

With no impairment of the interface signal, the resulting histogram will consist essentially of two vertical spikes. One is located at approximately the signal negative peak value and the other at the positive peak value. If the interface signal pulse top and bottom are clean and level (no tilt or aberrations), the spikes will be narrow and of high probability values. Slower rise and fall times cause each spike to broaden in the direction of zero volts. Normal mode noise causes broadening of each spike to both lower and higher amplitude values. If these impairments are severe enough, the two spikes will merge into

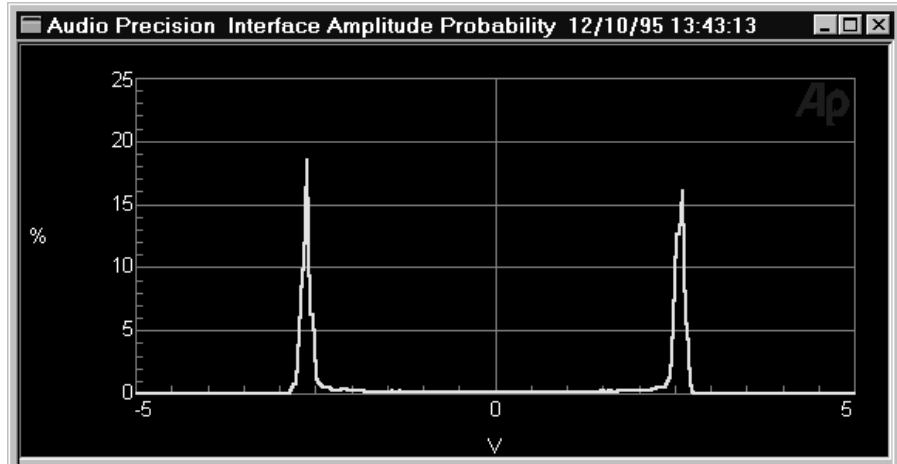

Figure 8-15 Probability vs Amplitude (5 V p-p Interface Signal)

a low probability “lump” spread across the peak-to-peak voltage range of the signal.

## Jitter Histograms

Another of the many statistical analyses performed by INTERVU are histograms of the Jitter signal. JITTPROB.AT2, supplied with System Two Cascade software, displays the probability distribution of the jitter signal. Intervu.Probability is selected as Data 1 and Source 1 is set to Intervu.Jitter. The Start time should be set to a negative value somewhat greater than the maximum expected peak jitter value and the Stop time at a symmetrical positive value. Good initial values are -50 ns for the Sweep Start and +50 ns for the Sweep Stop. If the data is concentrated in the center of the screen these values can be reduced. If it extends past the left and right graph edges they can be increased. When comparing histograms to the DIO panel jitter meter, remember that the DIO panel meter (and generator) calibration are in terms of peak values, starting with v1.50a of APWIN software. The graph Top value may be in the range of a few percent up to 50% and the graph Bottom value will normally be set at zero for linear displays.

The range of possible jitter values between the peak positive and peak negative jitter values in the current acquisition is divided into 256 “bins” by INTERVU, with the jitter of each data cell logged into the bin of corresponding value. The probability axis then displays, for each



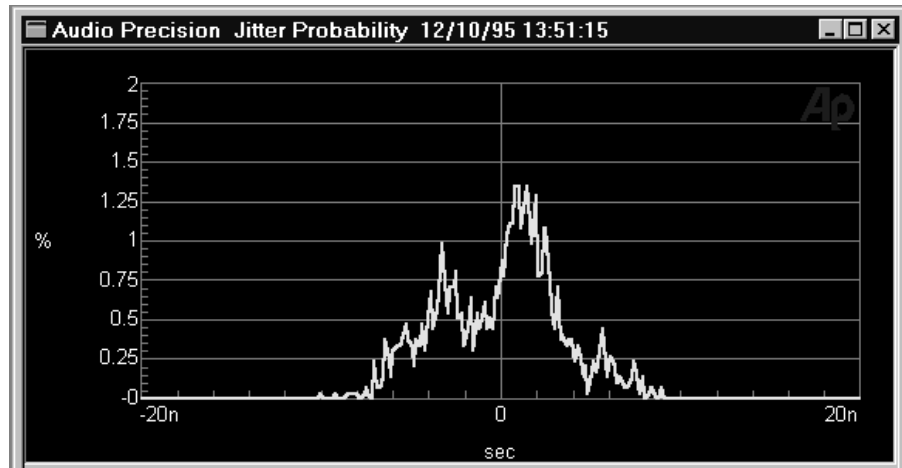

Figure 8-16 Jitter Probability

acquisition of the interface signal, the percentage of the total jitter measurements falling into each bin. If the span from Source 1 Start to Stop and the Source 1 Steps value produce fewer graphed data points than the 256 bins established by INTERVU, the DSP will sum the values across ranges of adjacent bins and send the summed values to APWIN software to be plotted.

The width of the histogram represents the peak to peak jitter. The breadth of the display near its midsection is indicative of the average jitter. A jitter signal with low average jitter will be represented by high probability of near-zero values. Signals with high average jitter are represented by values falling into bins farther away from zero. Squarewave jitter will tend to produce a strong pair of peaks in the display with a low amplitude area between them. These peaks will be at the positive and negative peak jitter amplitudes. Sinewave jitter will also produce a graph with two peaks but the curve between them will follow a gentle arc, much like the shape of a supported at each end by poles. Random jitter histograms will vary somewhat from acquisition to acquisition ( for example when using Sweep Repeat mode), while jitter dominated by a coherent signal will tend to be more consistent.

## Status Bits Panel

The AES/EBU professional and the consumer (sometimes known as SPDIF or EIAJ) standards for serial audio transmission include “administrative” data bits in addition to the bits representing the audio signal. One of the most important administrative bits is the Channel Status bit (C bit). Status bits are organized across blocks of 192 frames into 24 status bytes. Status bits are independent between Channels A and B, although typically they are duplicated on the two channels. The use and meaning of these status bytes is generally different between professional and consumer standards. Byte 0 defines, among other things, whether the bytes are to be interpreted according to the professional or consumer standard. The Status Bits panel permits setting the desired channel status information to be transmitted along with the audio data, and displaying the incoming status bit information. Status information may be set and displayed in both high-level English and as hexadecimal numbers. The high-level and hex settings and displays are both continuously functional, regardless of which format is used for output control.

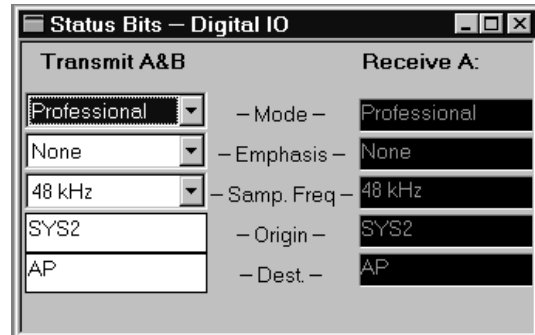



Figure 8-17 Status Bits Panel, Small Version

The Status Bits panel in the digital i/o versions of System Two Cascade is continuously available and functional, whether or not a digital analysis DSP program has been loaded.

To bring the Status Bits panel to the screen:

Mouse: Click on the Status Bits icon  on the toolbar or select Panels Status Bits via the menu bar

Keyboard: Type    (for Panels statUs bits) or  .

The Status Bits Panel may be displayed in small and large sizes. The small size version of the panel includes the Mode, Copyright,

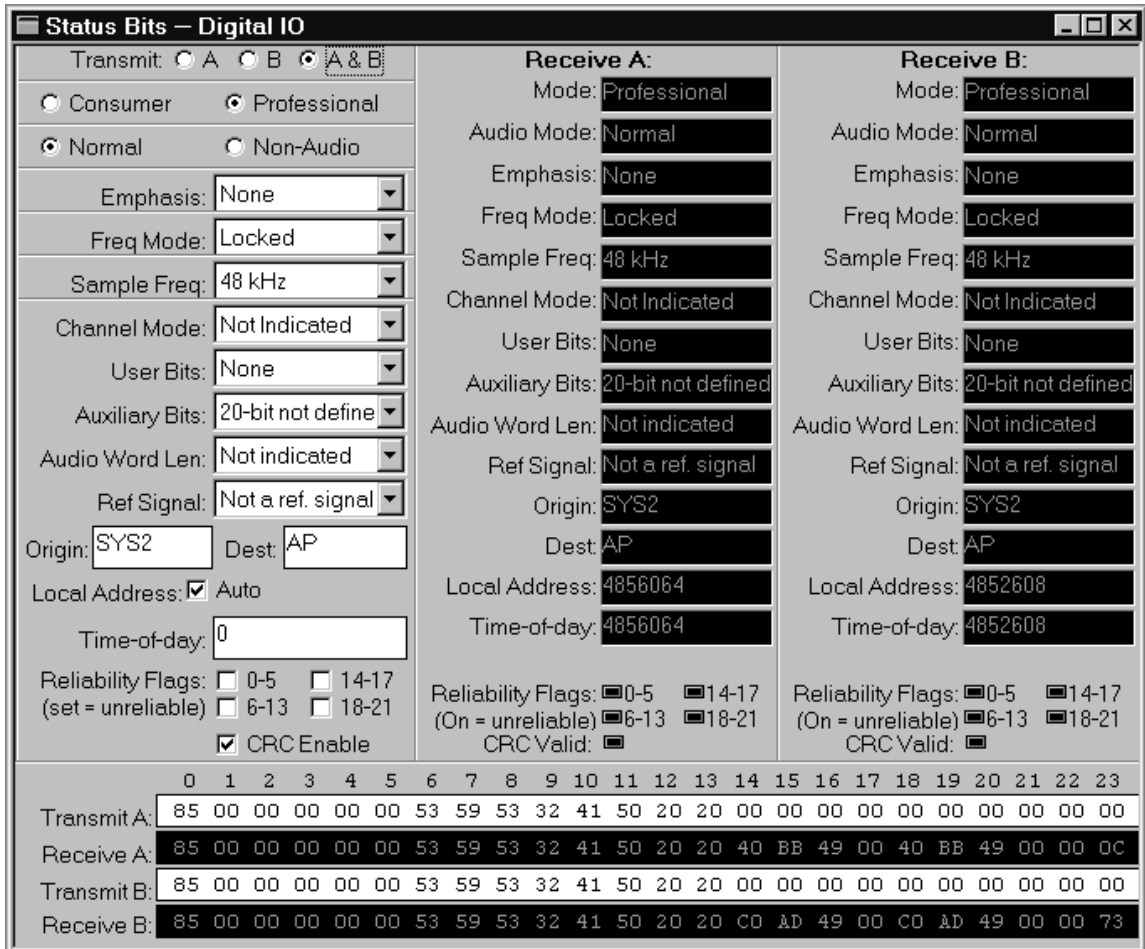

Figure 8-18 Status Bits Panel, Large Version

Emphasis, Sample Rate, and Category setting and reading fields when Consumer format status bytes are being transmitted. When Professional status bytes are transmitted, the small version Status Bits panel includes settings and reading fields for Mode, Emphasis, Sample Freq, Origin, and Destination. The large version of the panel includes settings and readings fields for all defined features in the Professional or Consumer standard. Clicking on the panel icon on the Panels Toolbar brings up the small version panel. Holding down the **SHIFT** key while clicking on the toolbar icon brings up the large version.

The large version of the Status Bits panel is organized into four sections: high level interpreted Transmit commands (at the left), high

level Receive A (center), high level Receive B (right), and hexadecimal settings and displays (across the bottom).

## Transmitted Status Bits Channel Selection

The high level Transmit section of the System Two Cascade Status Bits panel can simultaneously set the status bytes registers for both Channels A and B, or can individually make different settings to the A and B status byte transmit registers while the previous selections continue to be transmitted on the other channel. To select whether the high level settings in the Transmit section will apply to channel A, B, or both, click on the A, B, or A&B button at the top of the Transmit section

Selections of status bytes to be transmitted are made either via “radio buttons” or by clicking a down arrow at the right on a list box and then selecting the desired information from the list that appears.

The Origin and Destination sections of the Professional status bytes definition each permit a four-character alphanumeric (ASCII) code to be transmitted. The characters to be transmitted can be typed directly into the Origin and Dest. fields in the Transmit section.

The Local Address and Time-of-Day features are both timer functions defined in the Professional standard only. As implemented in System Two Cascade, if the Local Address Auto box is checked, both the Local Address value transmitted (bytes 14-17) and the Time of Day value transmitted (bytes 18-21) are continuously increasing counts, in audio samples, of the elapsed time since the Professional format of status bytes was selected or the Auto box was checked (whichever happens later). If the Auto box is not checked, an entry field for Local Address is displayed to the right of the Auto box. An entry field for Time of Day is always displayed in the next row. A fixed number may be typed into either or both of these fields and the  key pressed. The fixed number entered in each field will be continuously transmitted in the status bytes.

The four status byte Reliability Flags are defined only in the Professional (AES/EBU) standard. Each flag is to be set if useful information is not being transmitted in the corresponding status bytes,

so they really are Unreliability Flags. The first flag describes the validity of information in status bytes 0-5, the second flag covers bytes 6-11, the third flag bytes 12-17, and the fourth flag bytes 18-23. Note that these flags are not indications of the quality of the signal, but are simply a way for the transmitting device to tell the receiving device whether or not to pay attention to the information received in each group of six status bytes.

The AES3 standard defines byte 23 as a CRC (cyclic redundancy code) byte to assist the receiver in detecting errors in the preceding 23 bytes (0-22) of each channel status block. If the CRC Enable checkbox is checked, System Two Cascade will automatically compute a CRC byte based on the contents of the first 23 channel status bytes of each block and transmit it as byte 23. This is the normal mode of operation. If it is desired to test the error detection capability of a receiver, the CRC Enable box may be un-checked and arbitrary values may then be entered into byte 23 in the hexadecimal transmit field, using the  key to complete the entry.



## Received Status Bytes

The center and right sections of the Status Bits panel display, in high-level English terminology, the received status bytes. Channels A and B are displayed independently. The displays are up-dated approximately four times per second. When the received status byte code changes between Consumer and Professional, the remainder of the receive section of the panel will be re-drawn since most definitions are different between the two standards.

The four channel status byte Reliability Flags show whether the transmitting device is indicating that the corresponding bytes (bytes 0-5 for the first flag, 6-11 for the second flag, etc.) contain meaningful information. The transmitting device sets the flag if the corresponding status bytes are not meaningful, so a lighted indicator in the receive section indicates that the corresponding status bytes are not useful.

The CRC Valid flag for each channel will light if the received CRC byte (byte 23) indicates an error in any of the first 23 bytes of the channel status block.

## Hexadecimal Transmit and Receive

The bottom section of the System Two Cascade Status Bits panel consists of hexadecimal transmit and receive registers for both channels. The values in either transmit register may be changed by over-typing the existing values and pressing . The controls in the high-level Transmit section above will also change to follow changes in the hex settings. If the Transmit A&B mode has been selected by the buttons at the top of the panel, changing hex values in either Transmit A or B register and pressing  will cause the same change to be made to the opposite register. If either Transmit A or Transmit B mode is selected at the top of the high-level section, independent changes may be made in the A and B hex registers. Any such changes will be echoed in the high-level Transmit section above only if it is set to the channel currently being changed via hex settings. To change the hexadecimal Transmit A or Transmit B register settings, click on the desired transmit field. A vertical character cursor will appear. Use the horizontal arrow keys to move the cursor to the desired location and overwrite the sections of the entry to be changed. Press  to make the change.

## Parallel and Serial Interfaces

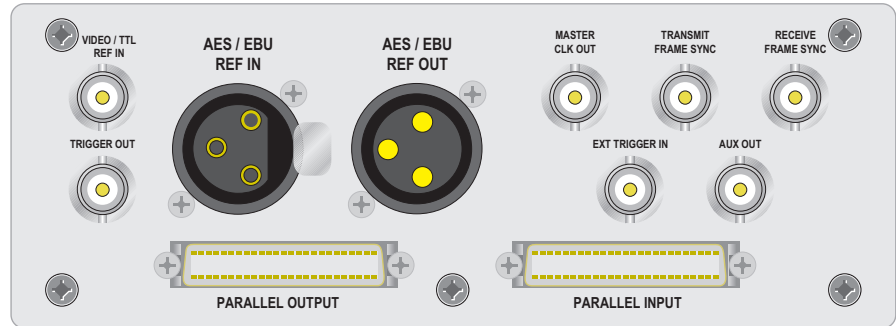

Figure 9-1 System Two Cascade DSP Rear Panel

In addition to the front panel AES/EBU inputs and outputs, System Two Cascade can test parallel interface and many serial interface digital devices via rear connectors. This chapter describes interconnection of the instrument to such devices.

### Parallel Digital Interface

The general purpose parallel ports are multiplexed dual channel, 24-bit linear 2s complement format. They are intended for connecting to parallel-interfaced A/D and D/A converters or for direct connection to DSP systems under test. They are also used to connect the SIA-2322 Serial Interface Adapter (optional accessory) to System Two Cascade Dual Domain.

#### Parallel Port General Information

The parallel ports are available on the rear panel of the system. The input and output each consist of a 50 pin dual row shielded connector. These connectors have ground pins on most contacts on the pin 26-50 side, adjacent to the 22 most significant bits on the pin 1-25 side, and are intended to be wired with twisted pairs for each data bit to maintain optimum waveshape and minimize

radio-frequency interference. To reduce the risk of damage it is strongly recommended that all connections to the parallel ports be made with power to the System Two Cascade turned off.

There are 24 data lines, a channel select line, and a strobe line. The remaining pins are grounds, plus one +5 V power line ( $V_{CC}$  in the table). The table below lists the pinout of both input and output connectors. Figure 9-7 illustrates the physical orientation of the pins on the connectors when viewed from the rear of the instrument.

### Parallel Input

The parallel input accepts 24-bit data on the data lines and latches it when the strobe line makes a transition from low to high. The data is latched into the channel A input when the channel select line is held low and the strobe makes a transition from low to high. The data is latched into the channel B input when the channel select line is held high and the strobe makes a transition from low to high. Latching

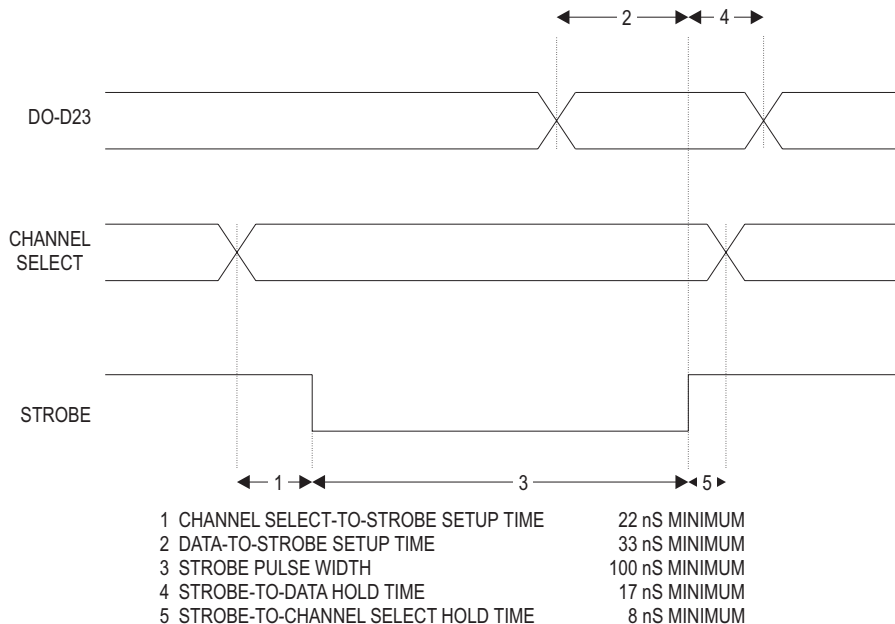

Figure 9-2 Parallel Input Port, Timing Relationships



channel B data also generates an interrupt for the System Two Cascade, causing it to read both channels of data just written to the latches. The channel select line must be held either high or low during the entire time the strobe line is low. A transition on the channel select line while the strobe line is low will cause an incorrect latch operation. Figure 9-2 illustrates the correct operation of the parallel input port and identifies the timing specifications for the operations. Note that data must always be supplied to Channel B since its latch operation triggers the DSP to read the data. If a single channel interface is desired, it must therefore be configured as Channel B and the channel select line connected to +5V.

All data inputs are TTL level-compatible high speed CMOS inputs. This allows connection to a wide variety of devices without loading concerns. The capacitance of each data line is approximately 10 picofarads. There are no termination resistors. If less than 24 bits are applied to the input, the data must be applied to the most significant bits and the unused LSB input lines should be connected to ground. The strobe line and channel select line are TTL level high speed CMOS inputs.

The channel select and strobe inputs are internally pulled high with resistors. If the pins are not connected, this will suffice to maintain the signals high. However, if wires are attached to either of these lines and bundled into cables with the data lines, there may be sufficient capacitance and mutual inductance to couple transitions into one or both inputs, causing mis-operation of the interface. To reduce the magnitude of this coupling, the channel select and strobe lines should be driven from a low impedance source. Using twisted pair or ground-plane ribbon cable may reduce the coupling of data-line transitions into the strobe or channel-select inputs. However, the added load capacitance on the data lines may increase the noise created by data transitions. Placing resistors of from 22 Ohms to 100 Ohms in series with the source outputs will reduce the rise time of signals and reduce coupling into adjacent lines. On bundled cables there may be significant inductive coupling between the data lines and the strobe line. If this occurs, the strobe line may be removed from the bundle and run separately from the remaining lines. Terminating the strobe and channel select lines with a resistive pull-up/pull-down

network at the connector may reduce the coupling and generally improve signal integrity. For most applications a 390 Ohm pull-up to +5V and a 220 Ohm pull-down to ground will present an adequate load for each line. These two networks may be powered by the +5V pin on the interface connector and should be mounted on the connector itself. Proportionately lower resistances may be required when the cable impedance is significantly lower.

Logic noise on the System Two Cascade ground connections may induce noise in the analog portions of the circuit being measured if care is not taken in the connections. This has resulted in some low level spurious noise observed when measuring oversampling A/D converters with switched capacitor input circuits. Oversampling A/D converters which use linear circuits for their loop filters have not shown similar sensitivity to ground noise, nor have conventional successive approximation converters. If ground noise effects are suspected, the grounds of the converter board under test and the System Two Cascade may be isolated with ferrite beads in the ground conductors or by opto-isolators in the data link.

If some of the bits (especially the sign bit) are allowed to leak into the analog signal it will result in odd harmonic distortion (3rd, 5th, 7th, etc.) in the measured results. Excessive distortion is often a clue to examine the leakage paths in the device under test.

## Parallel Output

---

Note that dither is also fully operational for the parallel digital output signal. See the dither section on page 10-20 for details. The output bits below the dither point are truncated by the DSP.

The output port provides data on the data lines at all times. The channel select line determines which channel's data appears on these lines. The output strobe line causes both channels of data to be updated, and signals the System Two Cascade processor that another pair of data words are required. The data is buffered with a two stage FIFO buffer which guarantees that data will be available when needed rather than after the processor's service delay. As long as the maximum sample rate restriction is obeyed the two-stage buffer will

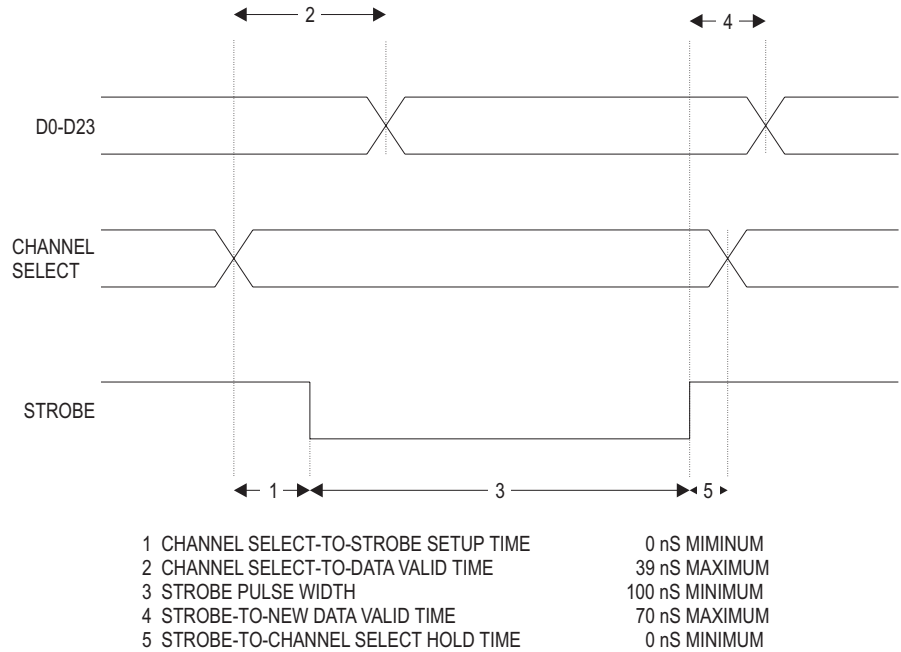

Figure 9-3 Parallel Output Port, Timing Relationships

never empty. Figure 9-3 illustrates correct operation of the parallel output port and identifies timing specifications for the operations.

Note that data may be read from one or both channels, as desired. However, the typical wiring connection to these ports provides an automatic strobe operation when the channels are read. If a single channel output is desired, the port should be configured as Channel B and the channel select line connected to the +5V supplied on the interface.

The parallel inputs and outputs may be operated at any sample rate selectable from the DIO panel. The internal sample clock generator appears on Transmit Frame Sync BNC on the rear panel. A 256x version of the sample clock appears on the Master Clock Output BNC on the rear panel. This higher frequency signal may be useful for clocking oversampling filters, delta-sigma converters, de-glitchers or similar circuits on the device under test.

There is no limitation that the input and output sample rates be exactly the same or synchronous.

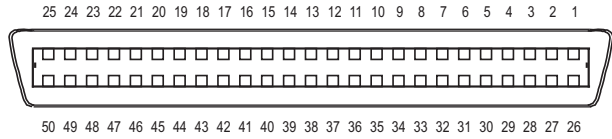

Figure 9-4 Parallel Input and Output Connectors

However, it is assumed that the sample data pairs are read and written at a constant sample rate. The small FIFO buffers will allow sample jitter in the input and output operations of as much as 3/4 of a sample period.

The strobe line and channel select line are TTL level high speed CMOS inputs. All outputs are CMOS with 50 Ohm build-out resistances and rise time limiting networks in series. This allows connection to a wide variety of devices without loading concerns. If less than 24 bits are needed, the most significant bits should be used and the unused LSB lines must be left unconnected.

The channel select and strobe inputs are internally pulled high with resistors. If the pins are not connected, this will suffice to maintain the signals high. However, if wires are attached to either of these lines and bundled into cables with the data lines, there may be sufficient capacitance and mutual inductance to couple transitions into one or both inputs, causing mis-operation of the interface. To reduce the magnitude of this coupling, the channel select and strobe lines should be driven from a low impedance source. Using twisted pair or ground-plane ribbon cable may reduce the coupling of data-line transitions into the strobe or channel-select inputs. However, the added load capacitance on the data lines may increase the noise created by data transitions. On bundled cables there may be significant inductive coupling between the data lines and the strobe line. If this occurs, the strobe line may be removed from the bundle and run separately from the remaining lines. Terminating the strobe and channel select lines with a resistive pull-up/pull-down network at the connector may reduce the coupling and generally improve signal integrity. For most applications a 390 Ohm pull-up to +5V and a 220 Ohm pull-down to ground will present an adequate load for each line. These two networks may be powered by the +5V pin on the interface connector and should be mounted on the connector itself.

Proportionately lower resistances may be required when the cable impedance is significantly lower.

### Parallel Interface Connector Pin Assignments

Pin #	Function	Pin #	Function
1	Channel	26	Vcc
2	Strobe	27	Ground
3	Bit 1	28	Bit 0
4	Bit 2	29	Ground
5	Bit 3	30	Ground
6	Bit 4	31	Ground
7	Bit 5	32	Ground
8	Bit 6	33	Ground
9	Bit 7	34	Ground
10	Bit 8	35	Ground
11	Bit 9	36	Ground
12	Bit 10	37	Ground
13	Bit 11	38	Ground
14	Bit 12	39	Ground
15	Bit 13	40	Ground
16	Bit 14	41	Ground
17	Bit 15	42	Ground
18	Bit 16	43	Ground
19	Bit 17	44	Ground
20	Bit 18	45	Ground
21	Bit 19	46	Ground
22	Bit 20	47	Ground
23	Bit 21	48	Ground
24	Bit 22	49	Ground
25	Bit 23 (MSB)	50	Ground

The +5V power line provided on the connectors is intended only to be used to tie unused data or control inputs high or to power termination networks if necessary. The power supply of the System Two Cascade has not been designed to source current to customer-supplied devices.

## Receive Frame Sync BNC

---

This output connector carries a square wave at the sample rate of the front panel AES/EBU or Consumer input signal. This allows triggering an oscilloscope off the received data words to view the waveform being received. Channel A or channel B of the interface may be selected by the trigger slope control of the oscilloscope.

## Transmit Frame Sync BNC

---

The internal sample rate clock signal is available at the Transmit Frame Sync BNC. This allows triggering an oscilloscope off the transmitted data words to view the waveform being transmitted. Channel A or channel B of the interface may be selected by the trigger slope control of the oscilloscope. When System Two Cascade's output sample rate is slaved to an external reference, the Transmit Frame Sync signal will be slaved to the applied reference. This signal is also used by the SIA-2322 and connects to it with a short BNC cable. This signal may be inverted via the "Invert Frame Sync" checkbox on the Sync/Ref panel.

## Master Clock Output BNC

---

This signal is a clock at 256 times the internal sample rate. For example, at a 48 kHz sample rate this signal will be a squarewave at 12.288 MHz. A jumper on the DIO circuit board can be set to determine whether this signal is jittered or not when jitter injection is selected on the DIO Panel. Adding jitter to this clock can be a useful test of D/A converters. Connecting this clock signal to the clock input of the SIA-2322 Serial Interface Adaptor and checking the "Jitter Clock Outputs" box on the Sync/Ref panel will pass that jitter on to the serial interface device being driven by the SIA-2322.

## Trigger Out BNC

---

The specific function of this connector will depend on the DSP program in use. If any function is implemented by a program it will be described in the particular DSP program chapter. This output is a 5 Volt CMOS/TTL compatible signal with a 50 Ohm source impedance.

---

## SIA-2322 Serial Interface Adaptor

---

An accessory unit, the SIA-2322, is available to greatly simplify connection of serial output digital devices other than AES/EBU and SPDIF/EIAJ to System Two Cascade Dual Domain. The SIA-2322 permits selection of a wide variety of serial formats of both one and two channels with from 8 to 24 bits to be interfaced simply by setting front-panel switches on the SIA-2322. MSB-first and LSB-first data can be used with a variety of word-strobe positions, in either TTL or CMOS logic families. Contact Audio Precision or your Audio Precision International Distributor for more information on the SIA-2322.





## Digital Generator

The digital generator is the only source of signals for the digital domain outputs of the SYS-2500 and SYS-2522, and provides output only at the digital output connectors. The digital generator always operates at the Output Sample Rate (OSR) set on the DIO panel. For information on DSP-generated signals in the analog domain, see the “(D/A)” waveform selections of the analog generator in the Analog Generator chapter. To bring the Digital Generator panel to the screen:

Mouse: click on the Digital Generator icon  on the Panels Toolbar

or

Select Panels Digital Generator via the menu bar

Keyboard: Type    (for Panels digital geNerator), or  .

The Digital Generator panel may be displayed in two sizes. The smaller version (displayed at when the panel is first brought to the screen) shows only the most important controls—waveform selection, frequency, secondary frequency parameters and amplitude ratio control for certain waveforms, the channel select and invert controls, track A (B follows A), output on/off button, and channel amplitude controls. The larger version shows these same controls plus the

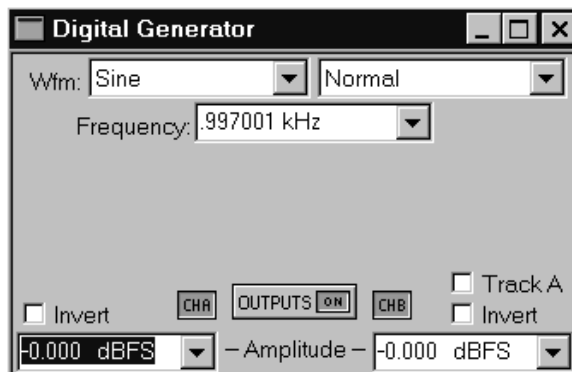



Figure 10-1 Digital Generator Panel, Small Version

Post-equalization amplitudes, EQ Curve selection button, Dither Type field, and reference values for scaling digital full scale to analog domain Volts plus dB<sub>r</sub> and relative frequency units. Clicking on the panel icon on the Panels Toolbar brings up the small version panel. Holding down the  key while clicking on the toolbar icon brings up the large version. To switch between the small and large panels:

Mouse:

Double-click anywhere in the panel title bar, or click on the middle of the three icons at the top right of the panel, in the control bar.

Keyboard: Press the  or  keys.

The System Two Digital Generator is independent from the Digital Analyzer and operates even if no digital analyzer has been selected. It is also independent from the status bytes and digital i/o panels. Digital Generator capability and the DSP-generated analog waveform capability are independent with the exception of Arbitrary Waveforms.

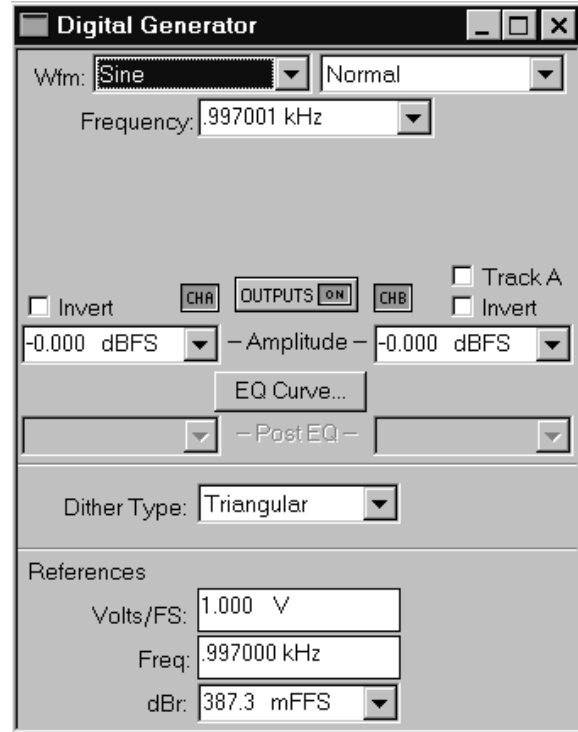
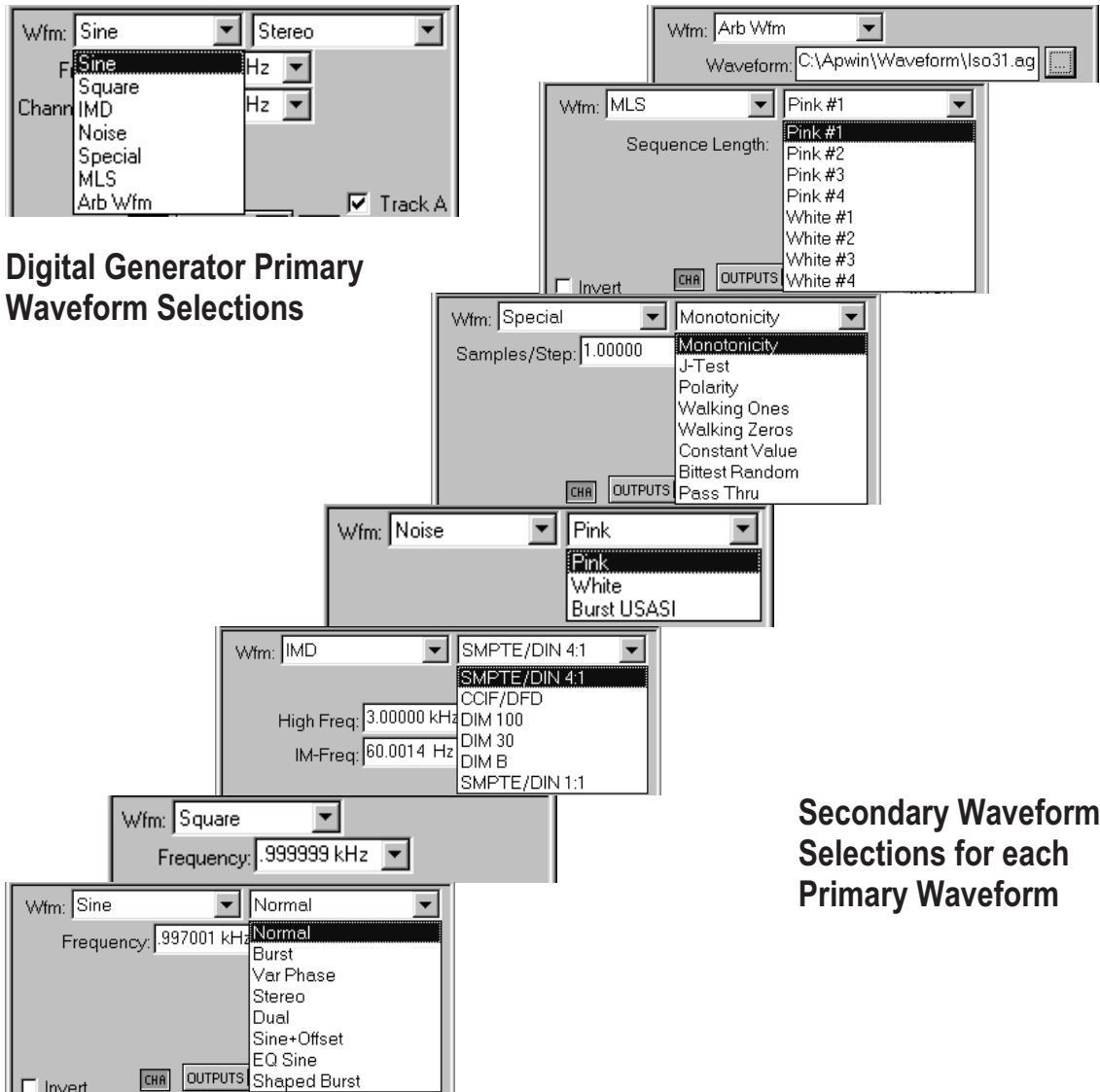

Figure 10-2 Digital Generator Panel, Large Version

## Digital Generator Waveform Selection

The output waveform from the digital generator is determined by the setting of two waveform fields at the top of the panel. A primary waveform selection is made in the left-hand (Wfm) field. Depending upon the primary field selection, a number of subsidiary choices are



**Digital Generator Primary Waveform Selections**

**Secondary Waveform Selections for each Primary Waveform**









Figure 10-3 Digital Generator Waveform Selections

then available in the right-hand field. Figure 10-3 shows the waveforms available from the digital generator. Note that digital generator waveforms and the DSP-generated analog generator waveforms (those with “(D/A)” as part of their primary field description) are totally independent with the exception of the Arbitrary Waveform selection. For example, the digital generator may be creating a Stereo Sine waveform at the digital output while a

DSP-generated, D/A-converted Sine, IMD, MLS, or Arbitrary Waveform is sent to the analog generator outputs.

To change waveforms:

**Mouse:** Click on the down arrow at the right of the box to display a list of available waveforms. Click on the name of the desired waveform to select it.

**Keyboard:** Shift the focus to the Digital Generator panel, if necessary, with the   keys. Select the desired Wfm field with the  key (moves selection downwards) or   keys (moves selection upwards). Press the  key to display the list. Use the   keys to move the waveform selection indication up or down the list. When the desired waveform is selected, press .

## Sine Waveforms

---

The secondary selections available with Sine waveform are Normal, Burst, Var Phase, Stereo, Dual, Sine + Offset, EQ Sine, and Shaped Burst.

### Sine Normal

The Sine Normal waveform is the standard waveform for most audio testing. Frequency coverage is from 10 Hz to 47% of the sample rate (22.56 kHz at a 48 kHz sample rate).

### Sine Burst

The sine burst waveform switches periodically between the normal, calibrated generator sinewave amplitude and a lower amplitude. Switching between the higher and lower levels always occurs at a positive-going zero crossing, thus there will always be an integer number of complete cycles in the burst. The duration and repetition rate of the burst are controllable, as is the lower amplitude.

### Burst Control

---

The burst control area of the Digital Generator panel consists of three additional fields labeled Burst On, Interval, and Low Level. The

maximum Burst length is 65,535 cycles of sinewave. The **Burst On** time may be set in cycles. **Interval** is the time from the beginning of one burst to the beginning of the next burst, not the time between the end of one burst and the beginning of the next. The maximum burst Interval is 65,536 cycles of sinewave. The amplitude of signal between bursts is controlled by the **Low Level** parameter. The Low Level value is relative to the Burst “on” level, which is the calibrated steady-state level controlled by the Amplitude field. The Low Level (low level) line controls the amplitude of the generator output between bursts. The Low Level amplitude may be set in any of four units:

- % lower level expressed as a percentage of calibrated level
- **dB** lower level in decibels relative to calibrated level
- **X/Y** ratio of lower level (X) to calibrated level (Y)
- **PPM** lower level in Parts Per Million of calibrated level value

The lower level amplitude may equal the upper level amplitude, in which case no burst effect will be visible. At large amplitude ratios, the amplitude resolution of the lower level becomes poorer. The display will show the actual available resolution steps, rather than the entered value. The lower level is limited to -120 dB.

## Sine Shaped Burst

A shaped burst, like a normal burst, consists of the sinewave frequency selected in the Frequency field, duration set in the Burst On field, and interval between the start of consecutive bursts as selected in the Interval field. The shaped burst differs in that the envelope of its amplitude

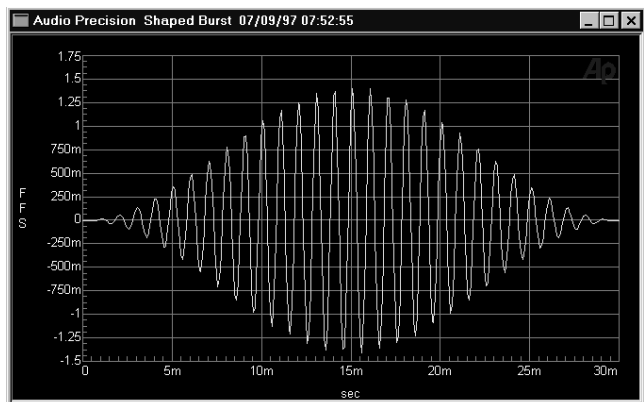

Figure 10-4 Shaped Burst of 1 kHz Frequency, 30 Cycles

follows a raised cosine shape rather than the rectangular shape of the normal burst; see Figure 10-4. The shaped burst energy is contained within a narrower spectrum around the sinewave frequency than the normal, rectangular burst. There is no lower level control with Shaped Burst.

### Sine Var Phase

---

This selection produces the specified frequency at both Channel A and B outputs, with the phase of the Channel B output variable from -180 to +179.9 degrees with respect to the Channel A output as controlled by the Phase field.

### Sine Stereo

---

This waveform selection produces independent sinewaves on Channel A and Channel B. The Frequency field sets the frequency of the Channel A signal and the Frequency 2 field sets the frequency of the Channel B signal. Their amplitudes are independently set by the two Amplitude fields unless the Track A box is checked, in which case the amplitudes are equal and controlled by the Channel A Amplitude field.

### Sine Dual

---

This selection produces two independent sinewaves, both of which are sent to both output channels. The Frequency and Frequency 2 fields permit each sinewave to be set independently in the range of 10 Hz to 47% of sample rate. The Dual Ampl Ratio field allows the user to set the amplitude by which the Frequency 2 field signal will be attenuated with respect to the amplitude of the Frequency field signal. The Sine Dual signal is particularly useful as a calibration signal for digital domain harmonic distortion and FFT analyzers, where the Frequency signal at reference amplitude represents the fundamental signal. The Frequency 2 field sinewave is set to any desired harmonic of the Frequency field “fundamental”, at an amplitude to represent any desired distortion level. For example, Frequency at 1 kHz and Frequency 2 at 3 kHz with a Dual Amp ratio of -40.0 dB (1%) furnishes a 1 kHz signal with third harmonic distortion of 1.0%.

## Sine + Offset

A sinewave from 10 Hz to 47% of the sample rate is combined with a digital DC signal (same as the Special Constant Value waveform). The sinewave amplitude is set, as usual, in the Amplitude field or fields. The DC signal amplitude, with a positive or negative value, is set in the Offset field. The total of the sinewave and DC amplitudes may not exceed positive or negative full scale. Thus, if the sinewave amplitude is zero the Offset value may be set anywhere in the range between -1.0 and +1.0 FS. If the sinewave amplitude is at full scale, the Offset must be zero. Warning messages will be displayed if entries are made into either Amplitude or Offset fields which would exceed full scale. The sequence of changing values in these fields is important, since APWIN will refuse to accept “illegal” combinations even when the user’s mental goal is a “legal” combination.

Sinewave amplitude may be individually set on the two channels. The Offset value is common to both channels. A low-amplitude sinewave with an Offset value to position it at a major bit switching point of ladder-type D/A converters is particularly useful for testing linearity at various points in their operating range.

## Sine EQ Sine—Generator Equalization

Real-time generator equalization of sinewave amplitude can be applied to the digital generator. Equalization works by specifying an amplitude vs frequency curve in the form of a specific reference filename and data column within the file. Sine EQ Sine must be selected as the waveform. At each frequency, equalization function modifies the value in the Amplitude field by looking up (interpolating when necessary) the correction factor from the equalization file for the present generator frequency. This value is sent as the desired amplitude command (post-EQ amplitude) to the instrument. The Post-EQ field shows the actual output level from the generator circuitry, after adjusting the user-requested (pre-EQ) value.

The Digital Generator will not permit an output amplitude entry greater than 1.000 FFS (zero dBFS). If the value of the normal (pre-EQ) Amplitude field as modified by the equalization file would attempt to produce an amplitude greater than 1.000 FFS, an error

message is displayed and the Amplitude field (pre-EQ) is set to zero. User entries may be made into either normal (pre-EQ) or post-EQ fields and the other field will be adjusted automatically. If a frequency value outside the frequency range span of the EQ file is entered on the generator panel or occurs during a sweep, the post-EQ amplitude will go to zero.

## Specifying the EQ Curve

Equalization will not occur until a file and column have been specified and the Sine EQ Sine waveform has been selected. The equalization file may be selected before or after selecting the EQ sine waveform. It is typically faster to first select the Sine EQ Sine waveform, since that results in a message that no file has been selected and the opportunity (by clicking the Yes button in the dialog) to select one. A browser appears which permits navigating to any desired directory and selecting an .ADQ file name. More than a dozen .ADQ files are furnished with APWIN, all located in the C:\APWIN\EQ directory. It is also possible to create your own custom EQ files as described later. After selecting the file, you must select a column which contains amplitude data. The furnished .ADQ files are all two-column files with frequency in column 1 and amplitude in column 2. The “Edit” button on the browser may be clicked to display, and edit if desired, the EQ curve data in the Data Editor. To view an EQ file graphically, use the File Open EQ command. Note that opening an EQ file does not change the Sweep panel settings, so it may be necessary to change Data 1 units and Optimize the graph for the desired display.

If you prefer to select the file and column before selecting EQ sine waveform, click on the “EQ Curve” button on the generator panel which displays the same browser just described. Actual equalization will not take place until the Sine EQ Sine waveform is also selected. When the Sine EQ Sine waveform is selected, the generator amplitude field or fields (pre-EQ) will display the setting in blue characters rather than the normal black. If Sine EQ Sine waveform is selected without an equalization file and column having been specified, APWIN software considers the equalization factor to be unity at all frequencies, so no equalization takes place.



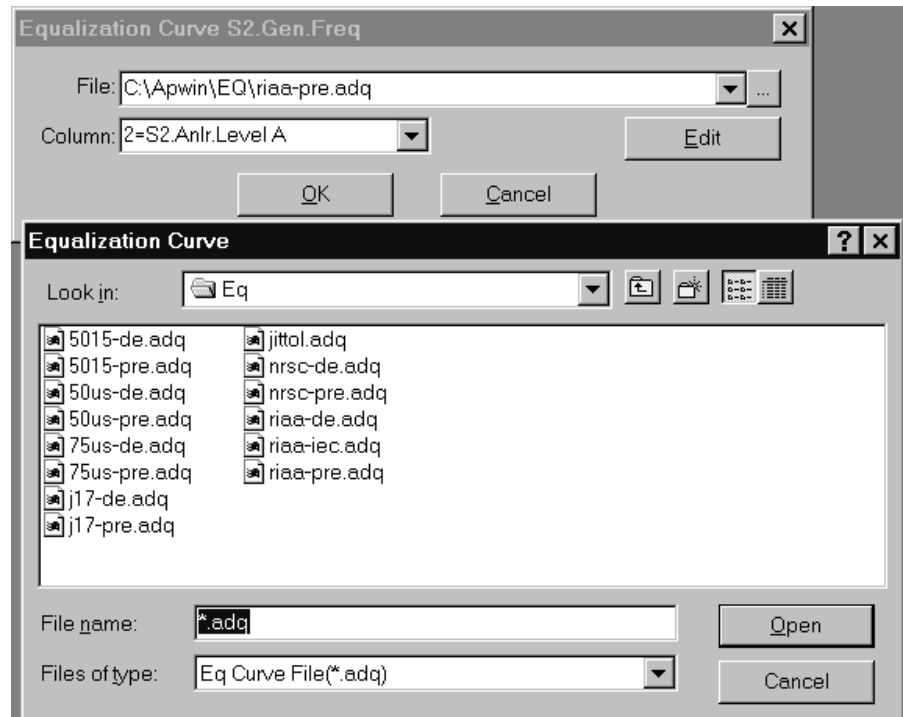

Figure 10-5 EQ Curve Selection Dialog and Browser

## Typical EQ Applications

The most common applications of generator equalization are to produce a nominally-flat output from a device which contains a known equalization function. Typical examples include fm and TV aural broadcast transmitters with 50 and 75 microsecond preemphasis curves. By connecting an equalization curve to the System Two generator that is the inverse of the nominal curve used in the device under test, the resulting measured output should be flat. Small variations from flatness will be a measurement of the accuracy of equalization in the device, since the .ADQ curves furnished are accurate to better than 0.01 dB and the specified generator flatness is of the same order.

## Squarewave

Square does not require a subsidiary waveform field. The squarewave is calibrated in peak equivalent sinewave terms. The

frequency range for squarewaves is from 10 Hz to 1/6 of the sample rate (8 kHz at 48 kHz sample rate, 7.35 kHz at 44.1 kHz rate). In order for the squarewave to be time symmetric and synchronous with the sample rate, the available squarewave fundamental frequencies within that range are limited to the even integer divisors from [sample rate]/4096 to [sample rate]/6. For example, at a 48 kHz rate, the highest squarewave frequencies are thus 8 kHz (48/6), 6 kHz (48/8), 4.8 kHz (48/10), 4.0 kHz (48/12), 3.42857 kHz (48/14), etc.

## IMD Test Signals

---

When IMD is selected, the second waveform field shows selections of SMPTE/DIN 4:1, CCIF/DFD, DIM 100, DIM 30, DIM B, and SMPTE/DIN 1:1.

Amplitude of the composite IMD test signals is controlled from the digital generator Amplitude field. All the IMD waveforms are calibrated to produce the same peak-to-peak signal amplitude that would be produced by a sinewave of the entered value. Thus, the IMD signal peaks will be 1.414 times the indicated amplitude (peak-to-peak, 2.828 times the indicated amplitude). The measured RMS value of all IMD waveforms will be different from the RMS value of a sinewave of the same peak amplitude. The applications advantage is that a device under test will not go into clipping when the signal is changed from a sinewave to an IMD signal at the same generator panel Amplitude value, but could clip if the true RMS value were constant between all waveforms.

### IMD SMPTE/DIN 4:1 and 1:1

These selections generate two sinewaves. The frequency of the reference amplitude signal is controlled by the IM-Freq field and may be freely set in the range from 40 to 500 Hz. The frequency of the high-frequency sinewave is controlled by the High Freq field and may be set anywhere from 2 kHz up to 47% of sample rate. The amplitude ratio of the High Freq sinewave to the low-frequency (IM-Freq) sinewave is 4:1 or 1:1, as specified in the second waveform selection field. The amplitude of the combined IMD test signal is calibrated at the same peak-to-peak value as a sinewave of the value set in the Generator Amplitude field.

## IMD CCIF/DFD

The CCIF/DFD mode produces two equal-amplitude sinewaves. The spacing between the two sinewaves is controlled by the IM-Freq field. The acceptable range for spacing is from 80 Hz to 2 kHz. The two signals are spaced by this amount around a center frequency value controlled by the Center Freq. field, but no signal is generated at the Center Freq value. The acceptable range for the Center Freq value is from 3 kHz up to 47% of sample rate, minus 1/2 the IM frequency spacing. For example, at a 48 kHz sample rate and a 1 kHz spacing, the highest acceptable Center Freq value would be 22.06 kHz ( $0.47 * 48000 - 500$ ). The amplitude of the combined IMD test signal is calibrated at the same peak-to-peak value as a sinewave of the value set in the Generator Amplitude field.

## IMD DIM (TIM)

DIM stands for Dynamic Intermodulation. An alternate frequently-used term is TIM, for Transient Intermodulation. A squarewave at a frequency near 3 kHz is generated and is linearly combined with the sinewave near 15 kHz. The peak-to-peak amplitude ratio of the squarewave to the sinewave is 4:1. The amplitude of the combined IMD test signal is calibrated at the same peak-to-peak value as a sinewave of the value set in the Generator Amplitude field. The specific squarewave frequencies are 1/16 the sample rate for sample rates above 46 kHz (3 kHz at 48 kHz), 1/14 the sample rate for rates between 42 kHz and 46 kHz (3.15 kHz at 44.1 kHz), 1/12 the sample rate for rates from 35 kHz to 42 kHz, and 1/10 the sample rate for rates below 35 kHz (3.2 kHz at 32 kHz). The specific sinewave frequency is at (100/21) times the squarewave frequency, producing a 15 kHz sinewave at the 44.1 kHz rate and 14.2857 kHz at the 48 kHz rate. The DIM 30 selection passes the squarewave through a 30 kHz low-pass filter if the Output Sample Rate (OSR) is 60 kHz or higher; otherwise the squarewave is intrinsically band-limited at OSR/2.

## Noise Waveforms

The Noise waveform secondary field selections are Pink, White, and Burst USASI.

## Pink Noise

The Noise Pink waveform is characterized by equal noise energy per fractional octave, fractional decade, or equal percentage bandwidth. Thus, the octave of pink noise between 5 kHz and 10 kHz will contain the same energy as the octave between 300 Hz and 600 Hz or the octave from 20 Hz to 40 Hz. A constant percentage bandwidth analyzer such as bandpass function of the analog hardware or DSP audio analyzers, and most real-time audio analyzers, will show a flat characteristic with frequency when measuring pink noise. A constant bandwidth spectrum analyzer such as an FFT analyzer will display pink noise as having a fall-off with increasing frequency, at the rate of 3 dB per octave. Pink noise will sound subjectively flat to the ear because the sounds are perceived on a constant bandwidth basis. When checking response of devices such as multiway loudspeaker systems, pink noise will supply more equal levels to low, midrange, and high frequency drivers than will white noise.

## White Noise

The Noise White waveform is characterized by equal noise energy per Hz of bandwidth. The 100 Hz-wide spectral range between 100 Hz and 200 Hz will thus have the same energy as the range between 10,000 Hz and 10,100 Hz. If analyzed by a constant bandwidth spectrum analyzer such as a superheterodyne or FFT analyzer, white noise will show a flat energy characteristic versus frequency (up to the bandwidth limitation). Analysis with a constant-percentage-bandwidth (constant Q) filter such as in bandpass function or most real-time analyzers will show a rising characteristic versus frequency, at the rate of 3 dB per octave.

## Burst USASI Noise

The Noise Burst USASI waveform selects a special two-level modulated waveform with noise spectral distribution similar to voice and music program material. The Federal Communications Commission in the U.S.A. specifically calls out this waveform as a modulation source while using a radio-frequency spectrum analyzer to measure the occupied bandwidth of amplitude modulated broadcast transmitters.

There is no frequency field for the Noise Burst USASI waveform. The Channel A and B Amplitude fields control amplitude at the two channel outputs. Calibration of the Amplitude field is the RMS value of a sinewave of the same peak-to-peak value as the waveform presently being generated.

## Special Waveforms

The Special waveforms are Monotonicity, J-Test, Polarity, Walking Ones, Walking Zeros, and Constant Value.

### Special Monotonicity

Monotonicity is a low-amplitude “staircase” waveform. It consists of five complete cycles of squarewave at each of the ten lowest non-zero amplitude states plus the same time period at zero. Since this definition is with reference to the minimum possible amplitude, the absolute amplitude of the steps depends on the Output Resolution (word width) value on the DIO panel. The squarewave half-cycle duration is controlled by the **Samples/Step** field. For example, with a Samples/Step value of 10 at a 48 kHz sample rate, the squarewave half-period is 208.3 microseconds (10/48000 of a second), each equal-amplitude section is ten half-periods long (2.083 milliseconds), and the entire eleven-step waveform repeats every 22.92 milliseconds

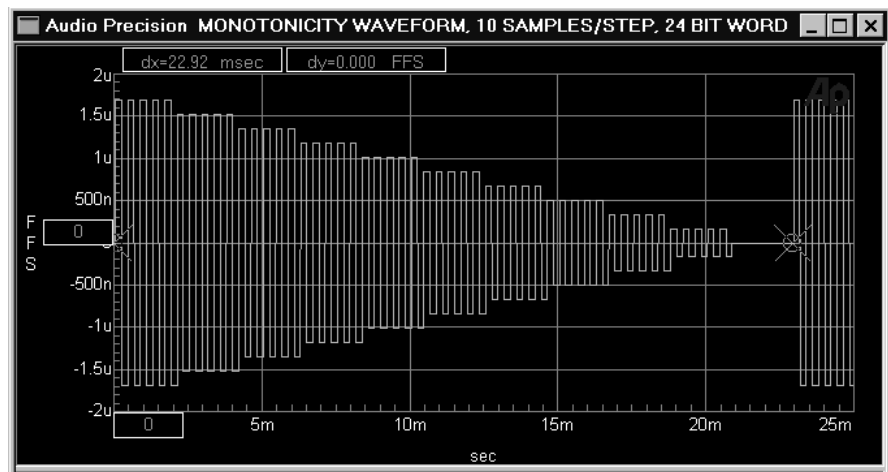

Figure 10-6 Monotonicity Waveform with 24-Bit Word Width, 10 Samples/Step, 48 kHz Sample Rate

( $11 \times 2.083$ ). The Monotonicity waveform is used principally in testing low-level linearity of D/A converters and digital domain devices by viewing their output in the time domain, using the FFT spectrum analyzer program. Non-linearity is shown by unequal step-to-step amplitudes. Non-monotonicity is indicated by a reversal in direction of the expected constant decrease from step to step. Dither is disabled when the Monotonicity waveform is selected. Select “Digital Gen” as the Trigger Source on the FFT panel. The Wave Display field on the FFT panel should be set to either “Display Samples” or “Absolute Value”, not “Interpolate”. See Figure 10-6 for an example Monotonicity waveform under the conditions described above, with 24-bit word width.

### Special J-Test

J-Test is a waveform which produces a maximum amount of data-induced jitter on low-bandwidth digital transmission links. J-Test consists of a squarewave at one-fourth the sample rate combined with a low frequency low amplitude squarewave with a DC offset. Dither is disabled for J-Test and no amplitude control is available, since the signal definition specifies exact data values. The J-Test signal would normally be transmitted while measuring jitter at the receiving end of a cable or digital transmission system, to estimate the worst-case magnitude of jitter caused by reduced bandwidth of the transmission link.

### Special Polarity

Polarity is a signal consisting of two sinewaves, a fundamental and second harmonic, phased so peaks reinforce each other in the positive direction and oppose in the negative direction. The polarity

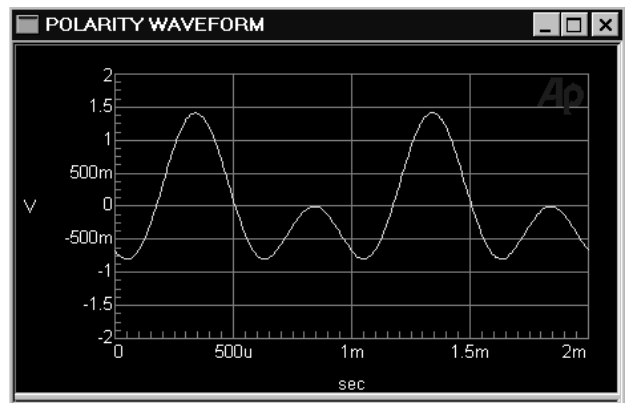

Figure 10-7 Special Polarity Waveform

waveform at the output of the device under test, displayed in the time domain by the FFT program as illustrated in Figure 10-7, will then show whether a phase inversion has taken place in the device or cable under test.

## Special Walking Ones and Zeros

Walking Ones is a signal in which only one bit is at logical one at any moment, with the others all at logical zero. The position of the bit which is at logical one is stepped continuously through the word from LSB to MSB to LSB and “around the corner” to MSB again, at a rate controlled by the **Samples/Step** field. Walking Zeros is similar except that only one bit is at logical zero and all others are at logical one. Walking Ones and Walking Zeros are typically used in troubleshooting circuitry where the word appears in parallel format, in order to find “stuck bits”. Dither is disabled for Walking Ones and Walking Zeros and the amplitude is fixed. The Walking waveforms can be observed on the DIO panel with the bit indicators in the “Data Bits” (rather than “Active Bits”) position if the Samples/Step value is set to about 24,000 (0.5 second per step) or greater. Slower computers may require a larger value for Samples/Step in order to be viewed on the DIO panel.

## Special Constant Value

The Special Constant Value “waveform” simply sends the same digital code at every sample. This is the digital domain equivalent of an analog DC signal. There is no frequency control field for the Constant Value signal. The Channel A and Channel B output Amplitude fields set the amplitude at which the signal remains. Dither is turned off with Constant Value “waveform”.

## Bittest Random

Bittest Random is a specific, predictable pseudo-random waveform uniformly distributed between plus and minus full scale. It is intended for error rate testing of communications links, AES/EBU interfaces, and digital recorders. It is identical to the Bittest Random waveform of System One and the RAND waveform of Portable One Dual Domain and may be used with the bit error analysis capability of either of those instruments. See the BITTEST chapter of this manual for more details.

## Pass Thru

The Special Pass Thru waveform uses the audio signal connected to the rear panel AES/EBU Ref In XLR connector (house sync). The Sync/Ref panel must be set to AES Sync Rate as the Source and the button to the right of the Source field must be turned ON for proper operation of Pass Thru.

## MLS (Maximum Length Sequence) Waveforms

The digital generator can generate 16 variations of a Maximum Length Sequence. A Maximum Length Sequence (MLS) is a pseudo random noise signal with the property that, when passed through a device and mathematically cross-correlated with the input signal to the device, the result is the impulse response of the device. An FFT can then be performed on that impulse response to yield the frequency and phase response of the device. See the Quasi-Anechoic Acoustical Tester (MLS) Chapter for a more complete description.

The Sequence Length buttons select between repetition lengths of 32k and 128k. The 32k repetition length sequences are identical to System Two and System One MLS sequences. The additional length of the 128k sequences is useful in large rooms with longer reverberation times. The 128k sequences are also useful at higher sample rates, such as 96 kHz, since the higher rates shorten the time duration of any particular sequence length.

The second field on the Waveform line selects from among four different MLS sequences (with two different frequency weightings) to avoid interference when several acoustical test stations are operating near one another. Each will cross-correlate to approximately -45 dB against any of the other three. The Pink #1, #2, #3, and #4 sequences are all weighted with a pink noise filter above 80 Hz to increase their low frequency energy relative to high frequency energy and provide a constant power per octave across the audio band. This greatly improves the signal-to-noise ratio at low frequencies, increasing measurement accuracy in typical room ambient noise conditions. The same four sequences are also provided without weighting, labeled White Noise #1, #2, #3, and #4 for unusual applications where the



large high frequency energy level may be desired and signal-to-noise ratio is not a concern.

## Arbitrary Waveforms

The Arb Wfm waveform selection (Arbitrary Waveform) permits generation of waveforms which have been stored as binary files on computer disk. These are typically multitone waveform files used for rapid measurements of response, distortion, noise, phase, and crosstalk/separation. When Arb Wfm is selected, a second field labeled Waveform appears, with an ellipsis button at the right to permit browsing among directories (folders) to select the desired waveform file. A number of useful waveform files are furnished by Audio Precision in the C:\APWIN\WAVEFORM directory. The user may create his own multitone waveform files by use of the furnished Utilities Multitone Creation menu command. Operation of this multitone creation utility is described the Multitone Audio Analyzer (FASTTEST) chapter.

Files displayed are of both the .AGM (generator, monaural) and .AGS (generator, stereo) file types. An .AGM monaural file consists of a single waveform, which will be loaded into both the left and right channel generator buffers for signal generation. An .AGS stereo file consists of two waveforms concatenated into one file. The first waveform in the stereo file loads into the left channel generator buffer and the second file into the right buffer.

If the “Set Sample Rate when loading generator waveforms” checkbox on the General tab of the Utilities Configuration dialog is checked, loading a waveform file also results in automatically setting the Output Sample Rate (OSR) to the value for which the waveform file was designed. This results in accurate output frequencies. If the box is not checked, the user is responsible for setting the OSR to the proper value. If the OSR is not identical to the value used in creation of the waveform file, all frequency components of the signal will be scaled up or down in frequency by the ratio of the two sample rates.

Note that the Arbitrary Waveform generation buffers of the analog generator and digital generator are shared. If both generators have Arb Wfm selected as the waveform, the same waveform file is used for

both and the same signal will be produced at both analog and digital generator outputs.

## Frequency Control and Units

The frequency of most waveforms is controlled by the Frequency field. The signal frequencies in arbitrary waveforms are determined by downloaded waveform files, so the Frequency field disappears when Arbitrary Wfm is selected. IMD DIM frequencies are automatically selected as a function of the Internal Sample Rate in use, so no frequency fields are displayed. Noise waveforms have no frequency parameter. The Constant Value “waveform” sends the same value sample after sample, so no frequency field is displayed. The Sine Stereo and Sine Dual selections produce two sinewaves controlled by fields are labeled Frequency and Frequency 2. In the IMD SMPTE/DIN and IMD CCIF/DFD waveforms, a second frequency parameter labeled is displayed. Several of the Special digital-domain signals must be synchronized to the sample rate, so a Samples/Step field is displayed instead of a Frequency field.

Frequency may be expressed in absolute units (Hz) and in a variety of units relative to the Reference Frequency value near the bottom of the Digital Generator panel. The Frequency box is a numeric entry field. New values may be typed or existing values edited from the keyboard, followed by the  key. Note that changing units does not change the frequency of the generator. The existing frequency will simply be re-stated in the new units.

## Channel Selection

The A and B channel selection buttons determine whether output channel A, B, both, or neither will have signal present when the On-Off button is On. To select output channels, click on either button to select or de-select the corresponding channel.

---

## Channel Invert

---

Either channel may be phase-inverted (180 degrees) by checking the Invert box near the On-Off button. Phase inversion of one channel with respect to the other is used to create subcarrier rather than main carrier output in some stereo multiplex broadcasting systems. When neither box is checked or both boxes are checked, the two outputs are in phase. To invert the phase of either output, click on the desired Invert check box.

---

## Track A

---

System Two digital generator output channels A and B have independent amplitude capability and can be independently set. For most audio applications, the same amplitude will be desired at both. In these cases, it is more convenient to make only one Amplitude setting which will be furnished at both channels. Check the Track A box for this mode. The B channel Amplitude field will disappear and entries in the A Amplitude field will control both channels.

---

## Output On/Off

---

The On-Off button turns on or off the output channels whose individual output control buttons are ON. The On-Off button is a “toggle” function, reversing output conditions each time it is pressed.

---

## Amplitude Control and Units

---

The output amplitude of each channel is determined by the setting in that channel's Amplitude field unless the Track A box is checked, in which case the Channel A Amplitude field controls both channels. Amplitude may be stated in digital and analog domain units. The analog domain units use the Volts/FS scale factor from the Reference section of the panel. This capability permits working with analog output amplitude values from a D/A converter under test when the full scale analog output amplitude of that D/A converter is known. See the Digital Amplitude Units topic for a discussion and definition of the

various digital domain units. A new amplitude value may be entered or the existing value edited from the keyboard, followed by .

Note that the actual output amplitude does not change when units selections are changed, but the existing amplitude is simply re-stated in the new unit. Note also that the value displayed after pressing  may differ slightly from the value entered (especially at extremely low amplitudes), since APWIN software will display the nearest amplitude which the instrument can actually generate.

---

## Dither

Dither is noise combined with the signal to improve linearity, reduce distortion at low amplitudes, and extend the linear operating range below the theoretical minimum for undithered PCM signals of any particular resolution. The additional noise is introduced before quantizing and serves to randomize the quantization distortion to produce an undistorted signal with a slightly higher noise floor. If dither has not been turned off by use of the “None” selection in the Dither Type field, the Output Resolution field on the DIO panel controls the amplitude of dither added to the digital generator output. For example, proper dither for a 16-bit system is obtained by entering 16 in the Output Resolution field.

For more information on dither, see the paper “Digital Dither: Signal Processing With Resolution Far Below The Least Significant Bit” by John Vanderkooy and Stanley P. Lipshitz, presented at the AES 7th International Conference “Audio in Digital Times” in Toronto on May 14-17, 1989.

---

### Dither Type

Dither of the digital output signal may be turned off or selected from three choices of probability distribution function and frequency spectrum in the Dither Type field. The selections are:

**Triangular** probability function dither has no noise modulation effect but produces a slightly worse output signal to noise ratio. Triangular dither can add or subtract up to one bit peak amplitude at the selected Resolution. Thus, Triangular dither increases the noise

floor more than Rectangular. Triangular is normally the preferred choice since it avoids modulation noise effects.

**Rectangular** probability function dither provides better signal to noise ratio than Triangular, but suffers from modulation noise effects. Rectangular dither can add or subtract only 1/2 bit amplitude.

**Shaped** dither is triangular probability distribution noise with a rising 6 dB/octave slope with zero dB effect at 1/2 the sample rate, thus placing most of the dither power at higher frequencies where some falls out of band of most devices and where the human hearing system is less sensitive.

The **None** selection turns dither off.

## Volts/FS Reference (Digital Generator)

When driving external D/A converters or more complex devices which include D/A converters, it is sometimes convenient to think of amplitude in analog rather than digital units. If the value in the Volts/FS Reference field is the analog output voltage of the D/A converter when driven to digital full scale, the various analog domain units (Volts, dBV, dBu, etc.) of the Digital Generator Amplitude field may be used. A new amplitude value may be entered into this field, or the existing value edited from the keyboard, followed by .

## Frequency Reference

The Digital Generator has a number of relative frequency units in addition to absolute frequency in Hz. When any relative frequency unit is selected, APWIN computes and sets the actual frequency based on the relative value in the generator Frequency field and the Frequency Reference value. A new value may be entered or the existing value edited from the keyboard.

## dBr Reference

When dBr units are selected in either channel's Amplitude field, the actual output amplitude is computed based on the decibel value

entered in that Amplitude field and the dBr reference value. The dBr Reference value may be stated in any of a number of amplitude units, including both analog and digital domain units. When analog domain units are selected for the dBr Reference entry, the V/FS field value will be used to convert the analog reference value into the digital domain.

## DSP Audio Analyzer

The DSP Audio Analyzer program (ANALYZER) is designed for both digital and analog domain input signals. It provides a DSP-implemented set of features similar in many ways to the hardware-implemented Analog Analyzer. This includes separate level meters for both channels, separate frequency counters for both channels, and separate flexible main meters (Function Reading meters) for both channels. The Function Reading meters have the ability to measure amplitude selectively or broadband but with a variety of high-pass, low-pass, and weighting filters, THD+N, SMPTE IMD, the ratio between the amplitudes on the two channels (with or without bandpass filtering on one of the channels), and interchannel phase. Two types of true RMS plus quasi-peak detector responses are available. One of the RMS detectors is a fast (synchronous) detector that can produce much more rapid measurements than the hardware Analog Analyzer. DSP Audio Analyzer can measure DC voltage on both analog and digital signals.

### DSP Audio Analyzer vs. Hardware Analog Analyzer

For digital domain signals, the DSP Audio Analyzer is the only general purpose real-time analysis instrument. For analog domain signals, the hardware Analog Analyzer and the DSP Audio Analyzer each have strengths and limitations.

- The hardware Analog Analyzer measurement bandwidth for level and frequency extends beyond 500 kHz, with THD+N measurement capability to 204 kHz. The DSP Audio Analyzer bandwidth is limited to approximately 100-120 kHz, with best performance below 30 kHz.
- The hardware Analog Analyzer has lower residual noise, lower residual distortion, and flatter frequency response than the A/D converters used with the DSP Audio Analyzer. However, the DSP Audio Analyzer's specifications are sufficient for a large

majority of audio devices to be tested. DSP Audio Analyzer's performance is best below 30 kHz, in the range of the High Resolution A/D converters.

- DSP Audio Analyzer has two Function Reading meters, one dedicated to each input channel, and thus can measure parameters such as THD+N, SMPTE IMD, crosstalk, etc., on both channels simultaneously during a single sweep. The hardware analyzer has a single Reading meter and requires two successive sweeps to measure parameters other than Level or Frequency on a two-channel device.
- The Fast RMS detector of the DSP Audio Analyzer permits frequency response sweeps many times faster than the hardware Analog Analyzer.
- Weighting filters for the hardware Analog Analyzer are an extra-cost option, while the DSP-implemented filters of the DSP Audio Analyzer are standard.
- The DSP Audio Analyzer tunable bandpass filter is sharper than the hardware Analog Analyzer.
- The 400 Hz high-pass filter of the DSP Audio Analyzer is steeper and has more ultimate rejection than either the standard or optional plug-in 400 Hz highpass filters of the hardware Analog Analyzer.
- DSP Audio Analyzer can accurately measure DC on analog or digital inputs.

The features and operation of the DSP Audio Analyzer are discussed in the following pages, organized according to the progression of panel fields from top to bottom.

## **DC/AC Coupling and DC Measurements**

The “Coupling” field near the top of the DSP Audio Analyzer panel controls AC or DC coupling or a DC-only path from the digital or analog input signal to the Level meters. The AC Coupling selection



blocks DC. The DC Coupling selection passes DC and AC, producing Level meter readings that are the RMS sum of AC and DC signals combined. The DC Only selection provides DC coupling and a low-pass filter, giving Level meter readings of only the DC component. The Function Reading meter path is always AC coupled.

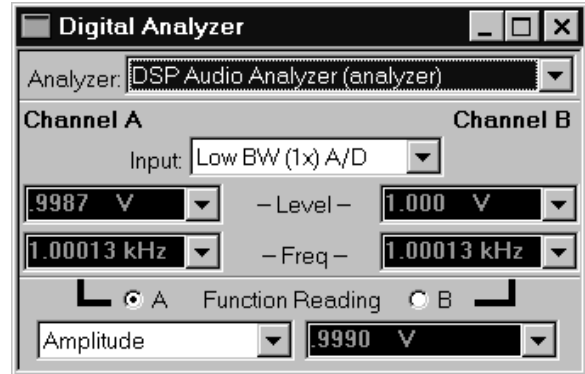

Figure 11-1 DSP Audio Analyzer Panel, Small Form

With the DC Only selection and digital input, measurement can be made of parameters such as DC offset at the output of an A/D converter. With any of the A/D input selections, DC Only provides approximately 0.5% accurate measurements of power supply voltages, offsets, and other analog DC voltages from 160 V down to millivolt levels. Detection is true RMS.

## Input Source Selection

The DSP Audio Analyzer can operate with either digital or analog domain input signals. The Input field near the top of the panel provides the following selections: **Digital**, **HiRes A/D @65536**, **HiBW A/D @131072**, **HiBW A/D @262144**, **HiRes A/D @OSR**, and **HiBW A/D @2xOSR**.

The “**Digital**” selection takes digital domain audio directly from the connector selected in the Input section (Format and connector selection radio buttons) of the Digital I/O Panel.

All the “**A/D**” selections choose the output of analog to digital converters fed from points following the input attenuators and balanced-to-unbalanced conversion circuitry of the two Analog Analyzer input channels. The Analog Analyzer’s autoranging circuitry or a fixed input range selection on the Analog Analyzer panel controls

the audio signal level at this point. DC or AC coupling is controlled as discussed above.

The two “**HiRes A/D**” selections use 24-bit high resolution converters with optimum sample rate ranges up to about 100 kHz. The “**HiBW A/D**” selections use 16-bit converters that operate to 262 kHz sample rates, but with 10-15 dB poorer residual distortion.

The “**65536, 131072, and 262144**” selections provide A/D sampling

rates at exactly 65,536 Hz, 131,072 Hz, and 262,144 Hz.

Corresponding signal bandwidths are approximately 25 kHz, 50 kHz, and 100 kHz. The two “OSR” selections refer to the value in the Output “**Rate**” field of the DIO panel (labeled “**Sample Rate-OSR**” on the large version of the DIO panel). With these selections, signal bandwidth will be approximately 40% of the selected sample rate value.

## Level Meters

Two Level Meters are located near the top of the ANALYZER panel, one for each input channel. The Level Meters are true RMS instruments. The Level Meters use the same type of detector that is selected in the “Det” (Detector) field below the center of the panel. Normal RMS integrates for a fixed period of time, while Fast (synchronous) RMS measures over a certain number of cycles of the waveform. For digital domain signals, the RMS value of a full-scale

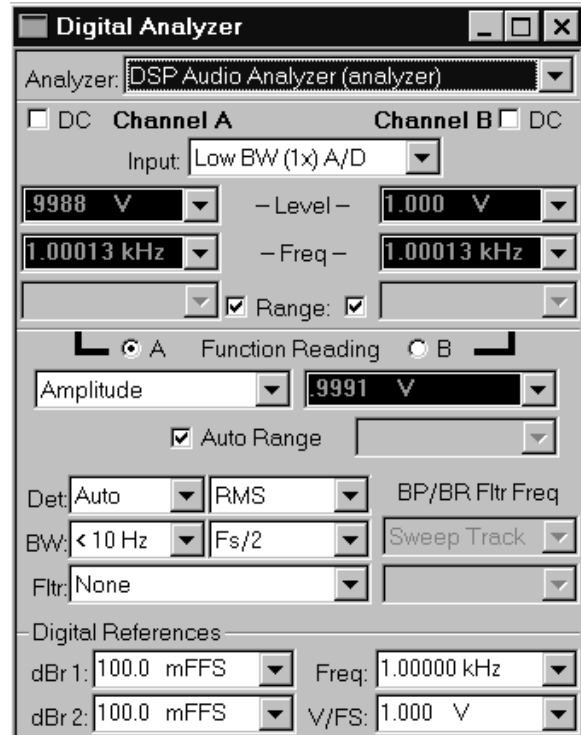

Figure 11-2 DSP Audio Analyzer Panel, Large Form

signal is defined in terms of a sine wave whose peaks just touch the maximum positive and negative digital codes. Therefore, digital full-scale signals with a lower crest factor than a sine wave can display RMS values greater than 1.000 FFS or 0 dBFS. For example, a square wave whose top and bottom are at the maximum digital codes will have an RMS value of 1.414 FFS (+3.01 dBFS).

## Level Monitor Units

Units available depend upon whether Digital or Low BW (1x) A/D is selected in the Input field.

When **Digital** is the Input selection, the available units include digital domain, relative (dBr), and analog domain units. The digital domain units are FFS, %FS, dBFS, and Bits. Relative units are dBr 1 and dBr 2 and are with respect to the values in the Digital References section at the bottom of the panel. The analog domain units are V, V<sub>p</sub>, V<sub>pp</sub>, dBV, and dBu. These analog domain units **when Digital input is selected** all make use of the V/FS scaling factor in the Digital References section at the bottom of the panel. If an A/D converter is being measured, the full-scale analog input voltage of the converter can be entered into the V/FS field and an analog domain unit then selected if desired.

When any of the **A/D** selections as Input, the available units are Volts, dBu, dBV, dBr A, dBr B, dBg A, dBg B, dBm, and Watts. The dBr A and dBr B units are relative to the dBr A and dBr B Reference values entered at the bottom of the *hardware Analog Analyzer* panel. The dBg A and dBg B units refer to the present output amplitude settings of the A and B channels of the *Analog Generator*; during an amplitude sweep or an equalized sweep, this would be the value at each current step of the sweep. The dBm and Watts units are computed assuming the measurement is being made across a circuit of the impedance value entered into the dBm or Watts Reference field at the bottom of the *hardware Analog Analyzer* panel.

## Frequency

The frequency of the signals on the two channels is displayed in the two fields labeled Freq, in the upper center of the DSP Audio Analyzer

panel. Units of measurement include Hz and a wide variety of relative frequency units (% , octaves, decades, delta %, etc.). All these relative frequency units are computed with respect to the Digital Reference Frequency value entered near the bottom right corner of the large version of the panel. For specific definitions of these relative frequency units, see the Frequency Units discussion in the Units chapter.

## Input Range

---

The DSP Audio Analyzer is normally operated with automatic selection of the input ranges. This provides the safest operation with no possibility of clipping due to high-amplitude signals. For special applications, it is possible to manually select the full-scale range. When ranges are selected manually, it is the operator's responsibility to assure that the peak signal level never exceeds the value of the selected range.

Manual range selection may be useful when listening to an audio signal on the built-in loudspeaker or via the headphone jack. When ranging is automatic, the audible signal level will be almost constant over a wide dynamic range. This may make it difficult to make adjustments to a device for minimum distortion or noise, for example.

## Function Reading Meter Function Selection, Display, and Units Selection

---

Panel features of the main (Function Reading) meters consist of a multiple-choice measurement function selection field, display fields for the two channels, and multiple choice selection of units of measurement for the display.

### Function Reading Meter Units

Units available depend upon the function selected and whether the Input is Digital or Analog (A/D). In the various ratio measurement functions (2-Channel Ratio, Crosstalk, THD+N Ratio, and SMPTE IMD), the available units are %, dB, and X/Y, independent of whether Analog or Digital input is selected. In the various amplitude-measurement functions (Amplitude, THD+N Amplitude, and Bandpass), the analog input and digital input units and their references are exactly as described above under Level Monitor Units. In Phase function, the only unit available is degrees.

## Function Reading Meter Measurement Functions

The Function Reading meter measurement functions available are Amplitude, 2-Ch Ratio, Crosstalk, THD+N Ratio, THD+N Ampl (amplitude), Bandpass, SMPTE IMD, and Phase.

### Amplitude

Amplitude function measurements can differ from the Level Meter measurements due to two factors:

- Amplitude function measurements are affected by the high-pass, low-pass, and weighting filter selections in the BW and Fltr fields, while Level meter readings are unfiltered. The Amplitude function must thus be used for weighted noise and band-limited noise measurements.
- Amplitude function measurements may be made with the quasi-peak or one of the RMS detectors, while the Level meters always use the same type of RMS detector selected in the Det field of the reading meter.

### 2 Channel Ratio

2-Ch Ratio function displays the amplitude ratio of the signal in the channel labeled at the top of each column of meter displays and the opposite channel. Thus, the Function Reading Meter display in the column below the “Ch A” heading displays the ratio of Channel A to Channel B amplitudes, and vice-versa. 2-Ch Ratio may be expressed in %, dB, or X/Y units. 2-Ch Ratio function is useful while adjusting stereo channel amplitudes to balance or for measuring gain or loss when the analyzer inputs are connected at the input and output of a device. The value displayed on each channel’s meter is the signal amplitude in that channel (numerator) divided by the amplitude in the opposite channel (denominator).

### Crosstalk

Crosstalk function is identical to 2-Ch Ratio function except that a tunable bandpass filter is also engaged in each channel’s Function Reading meter before the measurement. Crosstalk function will thus

provide more accurate measurements of low-amplitude signals in the presence of noise, since the filter will reject most wide-band noise. The filter must be tuned to the frequency of the signal on the driven channel. See the BP/BR Filter Tuning Source discussion below. Crosstalk may be expressed in %, dB, or X/Y units. The value displayed on each channel's meter is the signal amplitude in that channel (numerator) divided by the amplitude in the opposite channel (denominator).

### THD + N Amplitude

The two THD+N functions use DSP-implemented bandreject (notch) filters to remove the fundamental sinewave signal so that the detector may measure the remaining harmonic distortion products and noise. The THD+N Ampl (amplitude) function expresses amplitude of the remaining distortion products and noise in absolute units (FFS, %FS, dBFS, bits with digital signals: Volts, dBV, dBu, etc. with analog signals), independent of the amplitude of the fundamental signal. THD+N Ampl function is particularly useful when performing amplitude sweeps of audio devices, since it helps make clear that the noise component is constant amplitude unrelated to the signal amplitude. THD+N Ratio in an amplitude sweep obscures this fact, since the measured distortion and noise appears to increase with decreasing signal amplitude because it is being stated as a ratio to the decreasing signal.

The bandreject filter center frequencies may be fixed or may track one of several other parameters. See the BP/BR Filter Tuning Source section below.

### THD + N Ratio

Both THD+N functions use DSP-implemented bandreject (notch) filters to remove the fundamental sinewave signal so that the detector may measure the remaining harmonic distortion products and noise. The THD+N Ratio function expresses the distortion product and noise amplitudes relative to the amplitude of the unfiltered signal measured by the Level Meter. Units of % and dB (below fundamental) are commonly used in THD+N Ratio function. THD+N Ratio is used much more commonly than THD+N Amplitude, but in an amplitude

sweep THD+N Ratio appears to show increasing distortion and noise with decreasing signal amplitude because the distortion and noise is stated as a ratio to the decreasing signal. THD+N Amplitude may be more useful for amplitude sweeps.

The bandreject filter center frequencies may be fixed or may track one of several other parameters. See the BP/BR Filter Tuning Source section below.

## Bandpass

Bandpass function is a selective voltmeter (“wave analyzer”) implemented by DSP techniques. Each channel includes a narrow bandpass filter of about 1/13 octave ( $Q=19$ , 3 dB bandwidth about 5.2% of center frequency). The bandpass filter center frequency may be fixed or may track one of several other parameters; see the BP/BR Filter Tuning Source topic. The filter may be tuned to the steering source fundamental frequency or to the 2nd, 3rd, 4th, or 5th harmonic of the tuning source. This harmonic tracking ability permits swept measurements of individual harmonic distortion, limited to a maximum value of 42% of the sample rate.

## SMPTE IMD

SMPTE IMD (intermodulation distortion to the SMPTE or DIN standards) measures the amplitude of sidebands around the high-frequency component of a two-tone test signal. Appropriate test signals are generated by the Digital Generator and, if the analog hardware IMD option is present, by the analog hardware generator. The combined amplitude of these recovered sidebands is stated as a ratio to the amplitude of the high-frequency tone, with units of % or dB being the most common.

## Phase

The Phase function measures phase difference between the signals (which must be the same frequency) on the two input channels. The value displayed is Ch B minus Ch A, the same as the analog hardware analyzer and the calibration of the Sine Var Phase waveform of the digital and analog generators. The right-hand (Ch B) display is gray

when Phase is selected, since its measurement would be identical except for sign. Phase is always displayed in degree units.

## Function Reading Meter Ranging

---

The DSP Audio Analyzer is normally operated with automatic selection of the Function Reading meter ranges. This provides the safest operation with no possibility of clipping due to high-amplitude signals. For special applications, it is possible to manually select the full-scale range. When ranges are selected manually, it is the operator's responsibility to assure that the peak signal level never exceeds the value of the selected range.

Manual range selection may be useful when listening to an audio signal on the built-in loudspeaker or via the headphone jack. When ranging is automatic, the audible signal level will be almost constant over a wide dynamic range. This may make it difficult to make adjustments to a device for minimum distortion or noise, for example.

## Bandpass/Bandreject Filter Tuning

---

The DSP-implemented Bandpass filter affects only the Function Reading meters, not the Level Meter or Frequency readings. It is a highly selective filter of about 1/13 octave bandwidth ( $Q=19$ , 3 dB bandwidth about 5.2% of center frequency). The bandpass filter is tunable across the audio spectrum from 0.04% to 42% of the sample rate (20 Hz to 20 kHz at a 48 kHz sample rate). It is used in Bandpass and Crosstalk functions.

The Bandreject (notch) function of the filter is used in the two THD+N functions. It is tunable from 0.04% to 42% of the sample rate (20 Hz to 20 kHz at a 48 kHz rate).

Either the bandpass or bandreject form of the filter may be fixed in frequency or may be made to automatically track a parameter during a sweep test. The BP/BR Tuning field permits selection of the source of frequency steering information. Selections in this field are Counter Tuned, Sweep Track, AGen Track, DGen Track, and Fixed. The value in the "Fltr" field will further modify the Source value in Bandpass function if it is set to the "Narrow, Freq x2", "Narrow, Freq x3", "Narrow, Freq x4", or "Narrow, Freq x5" selection instead of



“Narrow”. The bandpass filter may thus be steered to the 2nd through 5th harmonic of the steering source frequency for individual harmonic distortion measurements.

- With **Fixed** selected, the filter will be fixed at the frequency entered in the BP/BR Filter Freq field just below unless the filter is being deliberately varied as part of a sweep test. To sweep the filter frequency during a test, select BP/BR Filter Freq as the Source 1 or Source 2 parameter on the Sweep panel. Fixed tuning mode must be selected in order to use the BP/BR Filter Freq parameter as a Source value.
- With **DGen Track** selected, the filter will automatically track the frequency of the Digital Generator. This mode would normally be used when sweeping digital input-digital output devices with stimulus coming from System Two’s digital generator.
- With **Counter Tuned** selected, the frequency value measured by the DSP Audio Analyzer Frequency counter is the filter steering source. This function would be selected when making THD+N or Crosstalk measurements from an external signal such as playback of a Compact Disc or audio tape or reception of a signal from a distant source.
- With **AGen Track** selected, the digital bandpass-bandreject filter tracks the frequency of the Analog Generator. This mode is useful for testing A/D converters driven from System Two’s analog output.
- With **Sweep Track** selected, the filter tracks the frequency of whichever generator is selected in the Source 1 or Source 2 fields of the Sweep panel.

## Highpass Filter

The Highpass Filter field is the left-most field on the BW line visible on the large form of the DSP Audio Analyzer panel. It is effective in all Function Reading meter functions except Bandpass and Crosstalk. It permits selection between essentially flat response at low frequencies (the <10 Hz selection) or specific highpass filters at 22 Hz, 100 Hz, or 400 Hz. A highpass filter, when selected, is connected in the Function

Reading meter measurement paths of both channels and does not affect the Level Meters or Frequency counters.

The 22 Hz and 100 Hz high-pass filter are four-pole (24 dB/octave) designs in all functions of the Function Reading meter. In the two THD+N functions, the 400 Hz filter also has four poles. In Amplitude or 2-Ch Ratio functions, the 400 Hz filter becomes an extremely sharp, high-rejection ten-pole elliptical high-pass filter. The 400 Hz filter selection in these functions permits quantization noise and distortion measurements of A/D converters and digital systems. Quantization noise and distortion measurements are typically made by driving a digital system at its full input amplitude range with a low-frequency sinewave (typically below 50 Hz) whose frequency is not integrally-related to the sampling rate. This signal exercises the A/D converter while the filter attenuates the fundamental and harmonics below approximately 220 Hz by at least 120 dB, but passes wideband noise above 400 Hz unattenuated.

Performance of the 22 Hz, 100 Hz, and 400 Hz highpass filters is independent of sample rate. The <10 Hz selection three dB point will actually vary from about 3 Hz at the very lowest (8 kHz) sample rate to slightly over 10 Hz at 192 kHz sample rates.

## Lowpass Filter

---

The Lowpass Filter field is the center field on the BW line visible on the large form of the DSP Audio Analyzer panel. Selected lowpass filters are effective (in both channels) of all Function Reading meter functions except Bandpass and Crosstalk. The field permits selection between essentially flat response at high frequencies (the  $F_s/2$  selection) or specific highpass filters at 20 kHz or 15 kHz.  $F_s$  refers to the currently selected sample rate, as determined in the Input field (and DIO panel if an “OSR” selection is made). The 20 kHz and 15 kHz lowpass filters are six-pole elliptic designs. Any lowpass filter, when selected, is connected in the main (Reading) meter measurement paths and does not affect the Level Meters or Frequency counters. Selection of a 20 kHz lowpass (or 15 kHz if specified) when making THD+N measurements is particularly important when measuring converters with large amounts of noise shaping.

Performance of the 15 kHz and 20 kHz lowpass filters is independent of sample rate at sample rates above approximately 44 kHz. As sample rates decrease toward twice the nominal three dB point of the selected filter, it essentially becomes the same as the  $F_s/2$  selection.

## Detector Reading Rate

---

The Reading Rate field (left-most field following “Det” label) controls the rate at which all the DSP Audio Analyzer meters update (integration time). The selections are Auto, 4/sec, 8/sec, 16/sec, 32/sec, 64/sec, 128/sec, and 256/sec. The actual measurement time for a given selection is different depending upon the detector response type selected. For RMS and Quasi-Peak, the measurement time will be approximately the period of the selected rate (for example, about 125 milliseconds at 8/sec). For the Fast RMS detector, the rate selected will set the minimum measurement period. The actual period may be longer, since with Fast RMS the measurement continues until the next positive-going zero crossing of the signal cycle.

Auto will normally be selected except for noise measurements. The Auto algorithm takes into account the signal frequency being measured, whether or not the bandpass filter is in use, and selects the fastest reading rate which will deliver specified accuracy under these conditions.

The 4/sec selection is recommended for noise measurements to provide integration of noise over a longer period. It may sometimes also be selected for the best accuracy and repeatability at very low frequencies.

The 8/sec, 16/sec, 32/sec, 64/sec, 128/sec, and 256/sec choices provide progressively faster measurements, but each has a progressively higher low frequency limit of accurate measurements. For bargraph display while making adjustments to a device under test, one of the faster rates may give better feedback to the operator.

## Detector Type

---

The second field following the “Det” label permits selection of detector type for the Function Reading meter of the DSP Audio

Analyzer. The available selections are RMS, Fast RMS, and Quasi-Peak. When either RMS detector is selected for the Function Reading meter, the Level meters use the same type of detection. When Quasi-Peak is selected for the Function Reading meter, the Level meters use normal RMS detection.

The RMS choice provides conventional true RMS detection with a measurement time approximately the reciprocal of the selected reading rate.

The Fast RMS selection provides synchronous RMS detection. The measurement time is synchronized with zero crossings of the signal waveform and will always consist of an integer number of signal cycles. Fast RMS can thus provide accurate measurements on as little as one cycle of signal. The actual measurement time is the sum of the reciprocal of the Reading Rate value plus the time necessary for completion of the cycle of signal in progress when the Reading Rate period expires. For example, if the Reading Rate is set to 64/sec (period of 15.6 milliseconds) and a 500 Hz signal (2 millisecond period) is being measured, the total time of each measurement could vary between 15.6 milliseconds and almost 17.6 milliseconds depending on the phase of the signal.

The primary purpose of the Fast RMS detector is for very rapid frequency response sweeps. For the greatest sweep speeds when measuring analog output audio devices, the Analog Analyzer input ranges should be fixed at a range which will handle the highest signal level anticipated. When measuring analog input devices, it is also recommended that the "Sine (D/A)" waveform of the Analog Generator be used rather than the hardware analog generator, to avoid the range switching which occurs at approximately 20 kHz, 2 kHz, and 200 Hz with the hardware generator. With these conditions, 30 to 50 point frequency response sweeps across the full audio spectrum can be made in one to two seconds. Four standard test files are furnished for fast response sweeps in all combinations of signal domain: analog-analog, analog-digital, digital-analog, and digital-digital. These tests are, respectively,

```
C:\APWIN\S2CASCADE\A-A\A-A FRQ RESP
FAST.AT2C, C:\APWIN\S2CASCADE\A-D\A-D FRQ
RESP FAST.AT2C, C:\APWIN\S2CASCADE\D-A\D-A
```

**FRQ RESP FAST .AT2C**, and  
**C: \APWIN\S2CASCADE\D-D\D-D FRQ RESP FAST .AT2C.**

Quasi-Peak provides a response conforming with the CCIR-468 specification for noise measurements. It is normally used in conjunction with the CCIR weighting filter.

## Weighting Filters (Fltr Field)

The field labeled “Fltr”, just above the Digital References section of the large form of the DSP Audio Analyzer panel, has different operations in different functions of the Function Reading meter. In Amplitude, 2-Channel Ratio, and the two THD+N functions, this field allows selection of Weighting Filters. In the Bandpass function, the field permits selection of whether the bandpass filter tunes to the fundamental frequency of the source being tracked or to the 2nd, 3rd, 4th, or 5th harmonics. In Crosstalk function, the selection is fixed at “Narrow”. In SMPTE IMD and Phase functions, the field disappears.

## Weighting Filters

Weighting filters are frequently required for noise measurements and sometimes for THD+N. Several selections are provided in the Weighting Filter field—None, “A” Weighting, CCIR Weighting, “F” Weighting, CCITT Weighting, and C-message Weighting. When any of these weighting filters is selected, it affects the Function Reading meter measurement paths of both channels and does not affect the Level Meters or Frequency counters.

“None” measures with flat frequency response from approximately 5 Hz to 1/2 the present sample rate, or a narrower range determined by any Lowpass and Highpass filter selections. “A” Weighting processes the signal through a psophometric weighting filter meeting the ANSI A weighting specification before measuring the resulting amplitude. An “A” weighting filter in combination with the THD+N function is frequently used for dynamic range measurements of A/D converters. CCIR Weighted processes the signal with a CCIR-468 weighting filter before measurement, and is normally used in conjunction with the 4/sec QPK Reading Rate selection. CCITT and C-message weighting filters are sometimes required for

telecommunications applications. The F-weighting filter is based on recent psychoacoustic research and relates to typical human hearing sensitivity at a sound pressure level of 15 phons.

The CCITT and C-message weighting filters are essentially voice-band filters and their shape is accurately held at all sample rates except for the frequency-shifting effect described in the following paragraph. The A, CCIR, and F weighting filters are specified to 20 kHz; at sample rates below 44 kHz, their response within a few kHz of 1/2 sample rate will deviate from specification.

Weighting filter responses are perfectly accurate at only the following sample rates: 8.000 kHz, 11.025 kHz, 12.000 kHz, 16.000 kHz, 22.050 kHz, 24.000 kHz, 32.000 kHz, 44.100 kHz, 48.000 kHz, 65.536 kHz (“65k A/D” Input selection), 86.200 kHz, 96.000 kHz, 131.072 kHz (“131k A/D” Input selection), 176.400 kHz, and 192.000 kHz. At any other sample rate, the filter shape is preserved but “slides” up or down in frequency by the ratio of the actual sample rate in use to the logarithmically-nearest sample rate from the list above.

### Bandpass Harmonic

In Bandpass function, the “Fltr” field offers the selections of “Narrow”, “Narrow, Freq x2”, “Narrow, Freq x3”, “Narrow, Freq x4”, and “Narrow, Freq x5”. The filter bandwidth is fixed at the normal 5.2% bandwidth value under all of these selections, but its center frequency is steered to different integer multiples of the BP/BR Source steering frequency.

### Digital References (ANALYZER)

The bottom section of the large version of the Digital Analyzer panel includes four reference values.

The dBr1 and dBr2 values serve as the reference for the dBr1 and dBr 2 units selectable at the Level Meters and at the Function Reading meter in absolute functions. The dBr1 and dBr2 zero dB reference values may be entered in digital or analog domain units. When analog domain units are used, the V/FS reference value (see below) is used to convert the analog zero dB reference value into the digital domain.

The Frequency value serves as the reference for the relative frequency units (octaves, decades, %Hz, etc) of the DSP Audio Analyzer Frequency counters.

The V/FS value is the analog-to-digital scaling value. When testing an external Analog to Digital converter (A/D), the value of analog input voltage that produces digital full scale output may be typed into this field. The Level Meters or Function Reading meter units may then be selected as V, Vp, Vpp, dBu, or dBV to express the measured digital amplitude in terms of the analog input value to the converter.

### **Sweep settings and readings (ANALYZER)**

When DSP Audio Analyzer is selected on the Digital Analyzer panel and “DSP Audio Anlr” is selected in the Instrument column of the Source and Data Browsers, the following Parameter selections are available for sweeps:

Readings (for selection at Data 1 through Data 6 to be plotted as traces): Freq A or B, Level A or B, and the DSP Audio Analyzer Function Reading meter function (2-Ch Ratio, THD+N Ratio, Crosstalk, etc.) presently selected.

Settings (for selection at Source 1 as the independent, swept variable or Source 2 for nested sweeps): BP/BR Filter Freq., but only if the BP/BR Filter Freq field on the DSP Audio Analyzer panel is set to “Fixed”.





## Digital Data Analyzer (BITTEST)

The Digital Data Analyzer program (BITTEST), in conjunction with certain specific signals created by the digital generator, measures the returned digital audio signals for bit errors. The audio test signal may be a pseudo-random noise sequence, constant valued samples (“digital dc”), a sinewave of selectable amplitude and frequency, or walking bit patterns. Generated word width must generally be equal to or greater than measurement word width, both controlled from the Digital I/O panel. The measurement displays both real-time received data and errors in the received data sequence. Any amount of delay between transmitted and received signals is permissible, allowing testing of devices and transmission links with large amounts of delay or even recorder-reproducers.

Dither cannot be used during BITTEST analysis except with sine waveforms.

BITTEST is useful for investigating the integrity of digital audio data links, recorders, etc. It is also invaluable for design test of digital interfaces. Each waveform measured by the program has a specific testing application. BITTEST operates only with digital domain input and output.

BITTEST is a real time program.

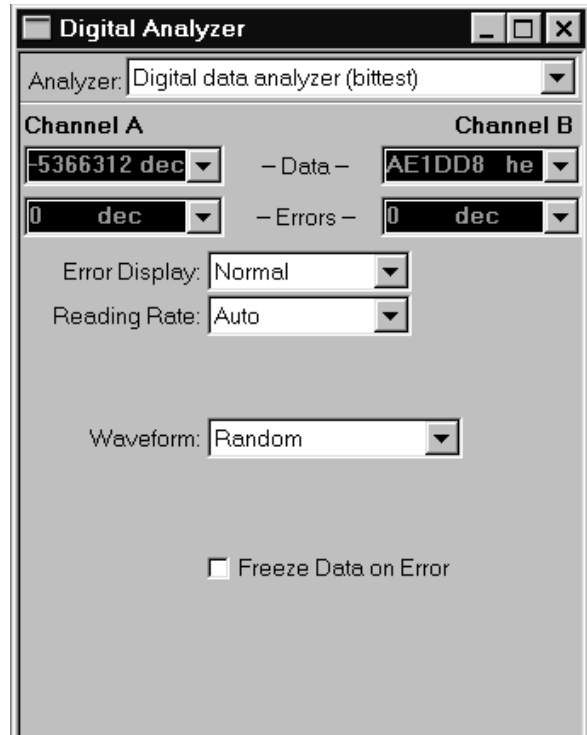

Figure 12-1 BITTEST Digital Data Analyzer Panel, Large Version

Measurements can be continuously observed in panel or bargraph modes. This is particularly useful for making adjustments on devices under test. The Data values and/or Error values may also be graphed versus time in chart recorder fashion, or against Digital Generator Amplitude (Special Constant “waveform”).

### Signal Compatibility for BITTEST

---

Signal generation must be coordinated with BITTEST analysis. BITTEST can analyze five different digital-domain waveforms: Random, Constant, Walking-1, Walking-0, and Sine. When testing real-time devices and using System Two’s digital generator, the same waveform must be selected on both the Digital Generator panel and the BITTEST analyzer. When analyzing a previously-recorded or distantly-generated signal, the Waveform field on the BITTEST analyzer panel must correspond to the waveform being analyzed. In some cases the System Two Digital Generator panel must also be properly set, since the BITTEST analyzer looks to the Digital Generator panel for certain signal parameter information even though the output of the generator may not be currently supplying the signal actually used.

#### Constant

The Constant waveform analysis mode expects a continuous stream of data samples at the same fixed value. This is the digital equivalent of a DC voltage source. The “Special Constant” waveform of System Two’s digital generator and the “Constant” waveform of System One’s BITTEST generator are both compatible with System Two’s BITTEST analysis. On the System Two Digital Generator panel, the data word to be generated is determined by the Amplitude field on the Digital Generator panel. **NOTE: generator dither must be turned off (None) for BITTEST analysis to function with the Constant waveform.** Constant mode aids in the investigation of data-dependent errors in digital systems. If a Constant waveform is digitally recorded and then reproduced, or is transmitted from a distant System, the local System Two Digital Generator Waveform must be set to Special Constant and the Amplitude field must be **exactly** the same as was recorded or is being transmitted even though the locally-generated waveform is not being used. The Output Resolution

(word width) on the Digital I/O panel must at least equal the Input Resolution for BITTEST analysis to function properly.

## Random

The Random waveform analysis mode expects a specific, predictable pseudo-random waveform uniformly distributed between plus and minus full scale. The System Two Digital Generator Waveform “Special—Bittest Random”, System One’s BITTEST Random waveform, and the RAND waveform of Portable One Dual Domain are all compatible. This signal is intended for error rate testing of communications links, AES/EBU interfaces, and digital recorders. It provides the most thorough error testing of any of the waveforms. Digital generator dither is automatically turned off in this waveform, so the Dither panel field setting of the generator used is not important. The Output Resolution on the Digital I/O panel must at least equal the Input Resolution for BITTEST analysis to function properly.

## Walking Bit

There are two walking bit modes. The Walking-1 mode sets all bits to 0 except one bit which is set to 1. This single high bit is continuously incremented from lower to upper bits. When it reaches the MSB it wraps around to the LSB of the selected word width (Output Resolution field, Digital I/O panel). The Walking-0 mode sets all bits to 1 except one bit which is set to 0. This single low bit is continuously incremented from lower to upper bits. When it reaches the MSB it wraps around to the LSB of the selected word width. System Two’s and System One’s Walking-1 and Walking-0 waveforms are compatible with BITTEST analysis. Digital generator dither is automatically turned off in this waveform, so the generator Dither panel field setting is not important. The Output Resolution on the Digital I/O panel must exactly equal the Input Resolution for BITTEST analysis to function properly.

## Sinewave

The Sine waveform is the only waveform of BITTEST that allows error checking of digital audio devices with gain or equalization. It is difficult to test such devices with bit-pattern-based test signals. The

sinewave retains its shape passing through any linear digital device. Good quality digital domain sinewaves from a wide variety of sources are compatible with BITTEST analysis—System Two, System One, Portable One Dual Domain, and even sinewaves recorded on test CDs. The sinewave analysis technique used by BITTEST will automatically adapt to normal dither levels, so Dither may be turned on or off.

### Signal Analysis (BITTEST)

---

#### Data Displays

Received data is displayed on the Ch 1 and Ch 2 Data fields at the top of the panel, truncated to the word length set in the Input Resolution field of the Digital I/O panel. Ch 1 refers to digital Channel 1 (subframe A) and Ch 2 refers to digital Channel 2 (subframe B). BITTEST cannot be used with analog signals. The Data may be displayed in decimal or hexadecimal units. The Data (and Errors) readings are updated at the rate selected in the Reading Rate field (Auto-4/sec-8/sec-16/sec) until an error occurs. When an error occurs (see below), the data display function depends upon the setting of the “Freeze Data on Error” checkbox. If the “Freeze” checkbox is checked, the Data fields will display the value that was received when the first error occurred. If the “Freeze” checkbox is not checked, the Data fields will continue updating, independently of any errors detected.

#### Error Displays

Received data is measured to determine if it matches the data transmitted. Only the number of bits selected in the Input Resolution (bits) field of the Digital I/O panel will be analyzed. This comparison is done with algorithms which are not sensitive to delay between the send and receive sections. The number of errors in the received data per measurement interval are counted independently for each channel. The Error Display field selects the type of analysis to be performed. In the Normal mode, the number of errors detected during the last measurement interval (1/4 second, 1/8 second, 1/16 second) are displayed directly in the Ch 1 and Ch 2 Errors fields of the panel. If Error Display is selected as Maximum, the largest error count during any one measurement interval will be held in the display. A running total of all errors may be accumulated by using the Totalize mode of

the Error Display field. To reset the Totalize or Maximum error displays, press Enter while the Error Display field is selected.

## Waveform

See the Signal Compatibility section above. All modes make error measurements based on the Waveform selection. The random, sine, and walking bit modes compare each successively received sample with the algorithm used to generate the signal. Two samples are required before the error analysis synchronizes with the signal, so errors may be indicated during the initial measurement interval even though no error actually exists. Constant mode requires that dither be turned off at the digital generator.

The Input Resolution (bits) field on the Digital I/O panel sets the number of input bits to be analyzed in all modes. It affects both data and error displays. If the transmitted signal does not have a resolution (word width) at least as great as the input resolution, errors will be displayed.

## Error Detection Flag

Whenever an error is detected the DSP will pulse the AUXILIARY OUTPUT (pin 11) on the rear panel 15-pin D-sub serial interface connector. This allows triggering an oscilloscope to observe received data errors. Since the error indication does not occur until after the end of the data word containing the error, a digital storage oscilloscope or logic analyzer is recommended. That instrument should be set in pre-trigger mode to acquire data before the trigger event.



## FFT-Based DSP Programs

FFT, FASTTEST, and MLS are FFT-based analysis programs furnished with System Two for use with both analog and digital audio signals. Although INTERVU is also FFT-based, it is dedicated exclusively to analysis of the serial digital interface pulse train via a 67 MHz converter and is discussed in the Serial Digital Interface Testing chapter. General and basic FFT concepts are discussed in this chapter. Individual chapters for FFT, FASTTEST, and MLS follow with description of specific control fields and operation of each program.

### System Two FFT Function

Figure 13-1 shows a functional block diagram of System Two DSP FFT programs. Only DSP Channel 1 is shown in detail; Channel 2 is identical. Not all the processing modes and window choices shown are available on every program. Operation of all FFT-based programs consists broadly of three steps:

- acquire signal
- compute
- display

In the “acquire” step, analog (via A/D converters) or digital signal samples are written into the Acquisition Buffers when the  function key is pressed (or equivalent action).

The contents of the “compute” step are widely different between time and frequency domain views, and upon the parameters to be viewed such as a high-resolution spectrum, multitone distortion, phase, or a masking curve.

The “display” step involves transferring the computed results, or more likely a summarized version of those results, from the DSP module to the computer for viewing.

13 fft basics

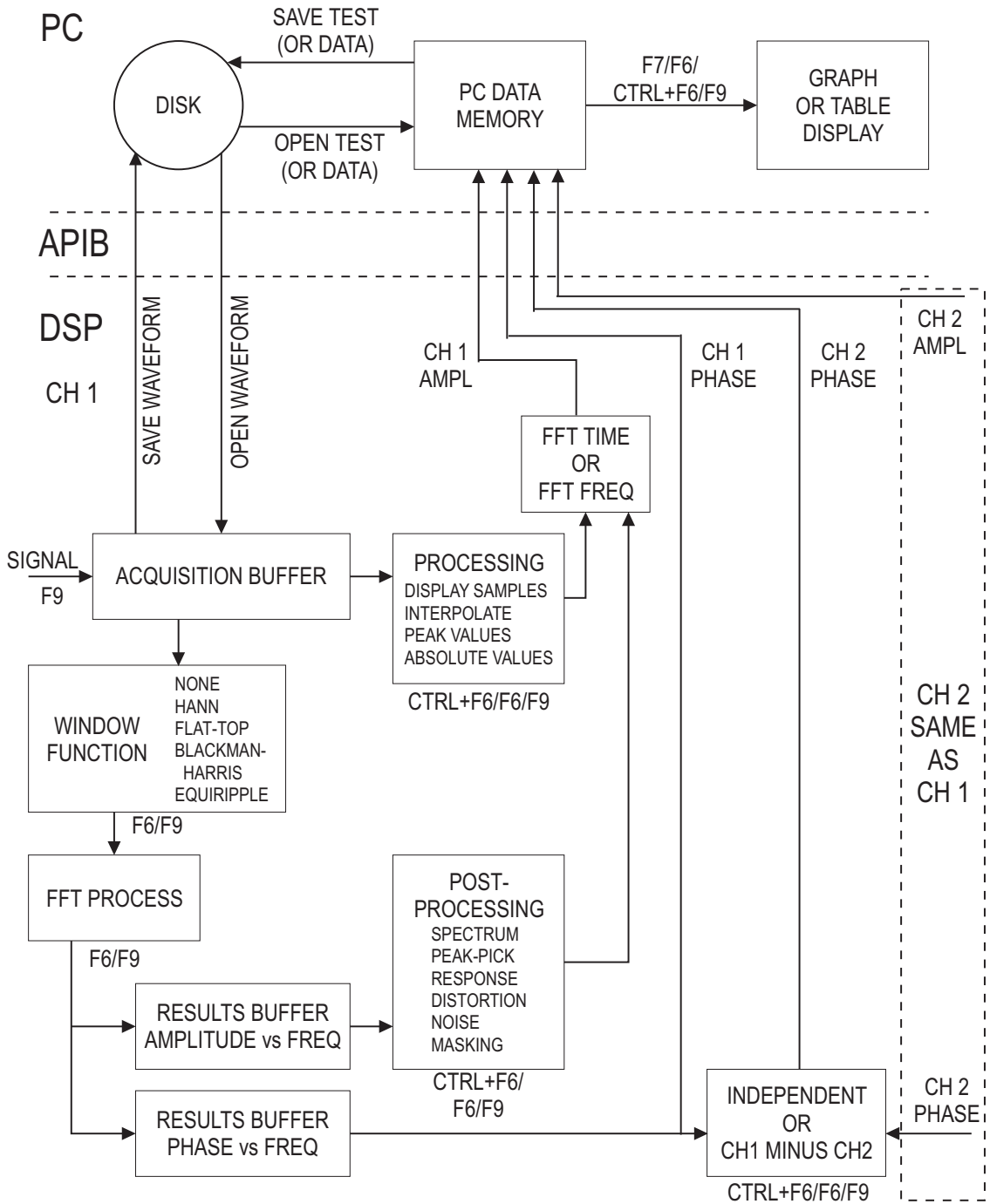

Figure 13-1 Function Block and Process Diagram, System Two FFT Programs





The acquired signal may be viewed in time or frequency domain mode, selected by the choices of FFT Time versus FFT Freq at Source 1 on the Sweep panel.

## Time Domain Basics

When time domain (oscilloscope) view is selected (FFT Time at Source 1), the amplitude values of the samples in the Acquisition Buffers are sent via the Processing block to the computer for display. The Start to Stop time span at Source 1 on the Sweep panel determines which section of the Acquisition Buffer is processed and sent to the PC. The waveform is displayed by selecting Ch 1 Ampl and/or Ch 2 Ampl at any of the Data 1 through Data 6 browsers on the Sweep panel. Waveforms are typically displayed using a linear vertical scale, graph top and bottom values symmetrically located above and below zero (ground), and a non-decibel unit (Volts or FFS or %FS) rather than a decibel unit.

### Time Domain Display Changes

Changes may be made in the selected units or graph top and bottom values and displayed most rapidly by the  key which simply re-graphs the present contents of the computer Data Memory without involvement of the DSP unit at all. Changes in the time span viewed (often by zooming with the mouse), displayed resolution (by changing the number of Steps), and processing mode are made most rapidly without acquiring or transforming signal again by use of the  keystroke. This causes a re-processing and transmission of the processed data to the computer for display, but no new signal acquisition or FFT transform.

### Graphic Resolution vs. Samples

In time domain (storage oscilloscope mode), the Start time, Stop time, and Steps (or Multiply or Stepsize) values on the Sweep panel may be set independently of the FFT Sample Rate. It is thus possible to view only a millisecond or two (48 to 96 samples at the 48 kHz sample rate) spread across the graph, in which case there are typically many plotted points per sample. It is equally possible to view several hundred milliseconds of signal (up to 24k samples with FFT or 16k

samples with FASTTEST) plotted across the graph with typically a few hundred plotted points, which results in one plotted point representing many tens of samples. This flexibility in graphing different plotted point-to-sample relationships can also produce problems in some situations, with several tools available to produce the best results.

## Graphic Aliasing

---

Graphic aliasing is a phenomenon which may occur in time domain presentations (oscilloscope view) of signals when there are a low number of points displayed per cycle of signal waveform. The result may appear to be a signal of a completely different frequency than the actual signal—even DC. For example, assume that a 1 kHz sinewave (1 millisecond period) signal has been acquired at a 48 kHz sample rate. Each cycle of signal is represented in the acquisition buffer by 48 samples. If the combination of Start and Stop times and the Steps values at Source 1 result in many plotted points per cycle of signal waveform, the representation on the graph will be accurate (particularly in the Interpolate waveform display option is chosen on the Digital Analyzer panel). If the time span from Start to Stop covers many cycles of signal and only a few points are plotted per cycle, the display can be very misleading. If the Start to Stop span is 200 milliseconds and the Steps value is 200, one point will be plotted per cycle of waveform in the DSP buffer. The result would be an apparent DC signal rather than a sinewave, since the one point plotted per cycle would be taken at the same phase angle from each cycle.

To help insure freedom from graphic aliasing, start out either with small time spans and relatively large numbers of Steps, or use the Peak Values or Absolute Values of the “Wave Display” field on the Digital Analyzer panel. These selections search through the range of samples in the DSP buffer between plotted points and return the highest value in that range to the computer for plotting, assuring that signal peaks cannot be missed. It may also be helpful to use a prime number such as 177 or 377 as the Steps value at Source 1 to reduce the likelihood of a synchronous relationship between this value and the signal period.

## Frequency Domain (Spectrum Analysis)

---

For frequency domain analysis, “FFT Freq” must be selected as the parameter at Source 1 on the Sweep panel.

The first (acquire signal) step of the process is identical for time or frequency domain viewing of a signal. The second (compute) step is much more complex for frequency domain than for time domain. There is typically pre-processing of the acquisition buffer contents before the FFT is computed and some post-processing of the spectrum analysis results before they are graphed. Pre-processing with the Spectrum Analyzer (FFT) program can include a quasi-AC-coupling computation (which also affects time domain displays) and application of a windowing function. With the Multitone Analyzer (FASTTEST), pre-processing can compare the acquired signal to a digitally-stored reference copy of the expected multitone waveform for the purposes of sophisticated triggering and frequency error correction. Post-FFT processing can include “peak picking” when there are more FFT bins than plotted points on the graph, plus (with Multitone Analyzer) specialized multitone signal post-processing for fast measurements of response, distortion, noise, phase, crosstalk, and computation of psychoacoustical masking curves.

---

## FFT Fundamental Relationships

---

A Fast Fourier Transform (FFT) is a mathematical process for deriving the amplitude and phase spectrum (amplitude versus frequency and phase versus frequency) from a sampled waveform (amplitude versus time) of a signal. Certain simple, fundamental relationships exist between the number of samples (transform length) making up the acquired waveform, the sample rate, and the frequency resolution of the resulting amplitude and phase spectra. The fundamental bandwidth-versus-sampling rate relationship of any sampling process is also relevant.

**Bandwidth = 1/2 sample rate;** for example, with a 48 kHz sample rate, the maximum signal frequency is 24 kHz. When analog signals are sampled and converted by A/D converters, the anti-alias filters used with the converters may further reduce the effective bandwidth.

**Frequency resolution = Sample rate / record length;** for example, with a 16,384 sample waveform and a 48 kHz sample rate,

the frequency resolution (also called **FFT bin width**, or **line spacing**) is approximately 2.93 Hz.

An FFT produces frequency-linear results; the resolution is constant across the bandwidth from DC (0 Hz) to 1/2 the sample rate. For example, with a 48 kHz rate and 16,384 samples, there will be 8,192 bins (lines), each 2.93 Hz wide, extending from 0 Hz to 24 kHz. The results of an FFT may be graphed on a logarithmic frequency scale if desired, but the actual FFT resolution is linear and thus equal across the spectrum.

The signal to be transformed is first acquired into a memory buffer called the acquisition buffer. The entire available acquisition buffer length is not necessarily filled each time signal is acquired, depending on the Transform Length setting.

The amount of signal actually acquired into this buffer is called the record length. FFT has acquisition buffers for both channels which are 256k (262,144 samples) long, although the user may choose to acquire shorter records into those buffers. FASTTEST has acquisition buffers 32,768 samples long for each channel.







<b>Program</b>	<b>Acq.buffer length</b>	Acq. time at 48 kHz
FFT	262,144 samples	5.46 sec
FASTTEST	32,7668 samples	682.66 ms

## Frequency Domain Basics

When frequency domain (spectrum analysis) view is selected by FFT Freq at Source 1, a portion of the Acquisition Buffer will be Fourier transformed. The portion transformed begins with the first sample of the Acquisition Buffer for Multitone Analyzer (FASTTEST). With Spectrum Analyzer (FFT) and Quasi-Anechoic Tester (MLS), a panel field defines the location of the beginning of the transform. The length of the Acquisition Buffer to be transformed can be adjusted in all three programs. The record to be transformed may be multiplied by a window function or (typically with synchronous signals) no window may be used. The FFT process results in magnitude (amplitude versus frequency) and phase (phase versus frequency) sets of results, each of which is stored in a separate Results Buffer.

The Amplitude vs. Frequency results are displayed by selecting Ch 1 Ampl or Ch 2 Ampl at any of the Data 1 through Data 6 browsers on the Sweep panel. Spectrum analysis is typically displayed either in a non-decibel units (Volts, FFS, or %FS) with a logarithmic vertical scale, or with a decibel unit.

## Frequency Domain Display Changes

Changes may be made in the displayed units or graph top and bottom values and re-graphed most rapidly by the  key. This simply re-graphs the present contents of the PC Data Memory without involving the DSP. Changes may be made in the window function, transform length, and transform starting point (with FFT) and displayed most rapidly by the  keystroke rather than acquiring signal again. The  key causes a new FFT transform and sends data to the computer but no new acquisition. Changes may be made in the post-processing selections of FASTTEST (for example, going from response to distortion to noise with a multitone signal), frequency span displayed by Source 1 Start and Stop, graph top and bottom values, displayed resolution via number of Steps, etc., most rapidly without either acquiring signal or transforming signal again via the  keys. The  keys re-process the existing FFT results according to the present settings on the Digital Analyzer and Sweep panels without either acquiring signal or performing a new FFT. Zooming in or out on the graph automatically sends a  command to the DSP unit unless this feature has been disabled by the Utilities Configuration command (Reprocess FFT Data on Zoom checkbox).

## Windowing Function

Unless the signal to be analyzed was deliberately generated in such a fashion as to be synchronous (to go through an exact integer number of cycles) with the transform buffer, a window function must be applied before the FFT is computed. (See the “None, sync to sine” section of the FFT chapter for an exception to this rule). Each available window function has a different set of trade-offs in effective close-in selectivity (signal spillover into nearby FFT bins) and in amplitude measurement error if the signal does not fall at an exact bin center frequency. The

available window selections for each analyzer program are discussed in the individual chapters.

## FFT Windowing Concepts

The fundamental mathematics behind a Fast Fourier Transform (FFT) makes the assumption that the portion of an acquired signal being transformed is a perfect, synchronous section of a signal which continues indefinitely. This is the same as assuming that if the section of signal in the transform buffer were spliced from the last sample to the first sample to form a loop and then “played back” continuously from that loop, the resulting signal would be identical to the acquired signal. In the real world, this is virtually never the case. Unless a test signal is deliberately generated in such a fashion that it goes exactly through some integer number of cycles in the length of the analyzer acquisition or transform buffer, there will be an amplitude discontinuity at the “splice”. Such a discontinuity results in energy spread across the entire spectrum, raising the baseline of the spectrum analysis to such high values that all but the strongest signals are buried.

The solution to this problem for typical, non-synchronous signals is to multiply the amplitude of all the samples in the transform buffer (amplitude versus time) by a “windowing” function before the FFT is computed. The windowing function has a value of unity (1.000) at the center of the buffer and drops to zero at the ends. The resulting “windowed” amplitude versus time signal will always splice smoothly without discontinuities, since the zero values at both ends match. The resulting FFT has greatly reduced signal energy across the spectrum. However, the “windowed” function is clearly not exactly the same as the original signal. The FFT of the windowed function is different in two ways from a theoretical synchronous FFT (if that were possible) of the original signal before windowing. First, some signal spillover (spreading) into several adjacent and nearby frequency bins above and below the actual signal frequency will occur, obscuring possible low amplitude signals at nearby frequencies. Second, the measured amplitude of any signal component will be somewhat lower than the true value unless that signal lies exactly in the center of an FFT bin. Bin centers are at frequencies exactly determined by sample rate and record length, and signal components being measured may fall at any point across a bin.

## Post-FFT Processing

At the conclusion of the Fast Fourier Transform, magnitude-vs.-frequency (and phase-vs.-frequency with FASTTEST and MLS) data arrays exist in DSP memory for both signal channels. Generally speaking, the entire contents of those arrays are not simply sent to the computer for display. The user-set Start and Stop frequency values on the Sweep panel may call for only a portion of the data to be sent to the computer. The number of Steps on the Sweep panel may be greater or smaller than the number of FFT bins in the Start-Stop frequency span, with either condition requiring some post-FFT processing. With FFT, a spectrum averaging feature is available to improve the signal to noise ratio of the displayed spectrum. In multitone analysis, different forms of processing are used in order to extract frequency response, phase response, total distortion and noise, noise in the presence of signal, psychoacoustical masking curves, and crosstalk from the FFT data.

### Displayed Points Do Not Equal FFT Bins

The maximum FFT Length is 32,768 samples, which results in 16,384 FFT bins (spectral lines). Since 1024 pixels is a rather high graphic resolution and the portion of the screen dedicated to the graph is only a fraction of that number, it is typical for the number of Steps at Source 1 on the Sweep panel to be set to 500 or less. Thus, many FFT bins are typically represented by one displayed point. In order to avoid missing significant signals, the DSP employs a form of post-FFT processing known as “Peak Picking”. When the computer requests data at two points which span more than one FFT bin, the DSP scans across all FFT bins between the two requested frequency points, finds the greatest bin amplitude, and sends that value to the computer to be graphed as the amplitude of the new point.

When the user has set Start and Stop frequencies to a small span, or zoomed on the graph into a small frequency span, the opposite situation may occur—there may be many displayed points per FFT bin. The computer may thus request data several times within the same FFT bin. In this case, the DSP simply returns the same bin amplitude value to each request that falls within the bin boundaries. With the typical 48 kHz sample rate and maximum 16384 sample FFT,

for example, the width of each FFT bin is about 2.93 Hz. If the graph has been zoomed in to a 100 Hz (34 bin) linear span with 500 steps, approximately 15 displayed points fall into each bin. The resulting graph has the appearance of a city skyline with rectangular flat-topped sections representing the width and amplitude of each bin.

## Transform Data without Acquire

---

FFT-based (batch mode) DSP programs have three distinct, sequential phases to their operation when the  key is pressed or Go button or green light icon is clicked. First, data is accumulated into the acquisition buffer until the buffer is filled to the specified acquisition length. Second, a Fast Fourier Transform (FFT) is performed to obtain amplitude (and sometimes phase) versus frequency data which is stored in a different memory buffer from the acquired signal (amplitude versus time). Third, a post-processed version of the amplitude versus time or amplitude versus frequency data (depending upon Sweep panel settings at Source 1 and Data 1 or 2) is transmitted from the DSP module in the test system to the computer for graphing by APWIN software. See the FFT functional block diagram on page 13-2.

It is often desirable to re-transform the data already present in the acquisition buffer, rather than acquiring new data. This will be the case when a previously-acquired waveform is downloaded from computer disk to the DSP module for further analysis. It will also be the case if it is desired to re-transform the existing contents of the acquisition buffer while using a different window function.

The Transform Data without Acquire command on the Sweep menu, or the equivalent  keystrokes, cause the second and third phases described above to take place (FFT transformation and transmission of results to computer).

## Reprocess Data

---

FFT-based (batch mode) DSP programs have three distinct, sequential phases to their operation when the  key is pressed or Go button or green light icon is clicked. First, data is accumulated into the acquisition buffer until the buffer is filled to the specified acquisition length. Second, a Fast Fourier Transform (FFT) is performed to obtain



amplitude (and sometimes phase) versus frequency data which is stored in a different memory buffer from the acquired signal (amplitude versus time). Third, a post-processed version of the amplitude versus time or amplitude versus frequency data (depending upon Sweep panel settings at Source 1 and Data 1 or 2) is transmitted from the DSP module in the test system to the computer for graphing by APWIN software. See the FFT functional block diagram on page 13-2.

It is sometimes desirable to perform a new post-processing of the FFT results and transmission of the post-processed data to the computer for display, without either acquiring new data or re-transforming the data already present in the acquisition buffer. This is faster than re-transforming followed by new post-processing. It is automatically done (unless turned off in the Utilities Configuration menu) when zooming in on a section of an FFT display and wishing to obtain optimum resolution of the new sub-set of the original data, or when changing multitone post-processing methods between the normal (response and level), distortion, or noise functions.



The Reprocess command on the Sweep menu, or the equivalent  keystrokes, cause the third phase described above to take place (post-processing of FFT results and transmission of results to computer).

### Re-Process FFT Data on Zoom

When this box is checked, each graph zoom in action (by dragging the mouse) or Zoomout or Zoomout to Original action (right mouse button menu on graph) will be accompanied by a “Sweep Re-Process Data” () command. If the acquired signal is still in DSP memory, this assures that the resolution is always the maximum supported by either the number of points graphed or the FFT transform length.

### Saving and Loading Waveforms

The complete contents of the Acquisition Buffers, or smaller sections of one or both channel buffers, may be saved to computer disk for a later download to the DSP and continued re-analysis. “Before and after” results may be viewed by saving a waveform to disk from one set of conditions, changing the device or configuration and

saving new results, and then downloading one saved waveform into the Ch 1 DSP Acquisition Buffer and the other into Ch 2. The two buffers may then be compared in time or frequency domain, using the  or  keystrokes described above as appropriate. See the Saving and Loading Waveforms sections of the individual chapters for details.





## DSP Memory vs. PC Memory

The full set of original signal samples remain in the Acquisition Buffer until:

-  is pressed again, or
- a different waveform is downloaded from computer disk, or
- the DSP program is changed (selection in Analyzer field at top of Digital Analyzer panel is changed), or
- power to System Two Cascade is turned off.

The spectrum analysis results remain in the Results Buffers until one of those same events, or

-  is pressed again.

Only a processed (and usually very abbreviated) version of the data is ever in APWIN Data Memory in the computer. For example, assume a 16384 sample Acquisition Buffer and a 48 kHz Rate. Following , the Acquisition Buffer therefore contains over 341 milliseconds of signal represented with 48 samples per millisecond. If Sweep Source 1 is set to a Start time of zero, a Stop time of 2 milliseconds (typical if viewing a 1 kHz signal), and a Steps value of 200, the computer Data Memory will contain 201 amplitude values at 10 microsecond intervals. Changing the Stop time to 10 milliseconds and pressing the  key (re-graph contents of computer Data Memory) will only show signal in the first 2 milliseconds; nothing beyond that has been sent from DSP to computer since the Sweep Stop value was 2 milliseconds when  was pressed. Pressing  (or ) will then send data from the first 10 milliseconds of DSP Acquisition Buffer to the PC. If the Steps value was not changed, there

will still be 201 amplitude values but now spaced at 50 microsecond intervals. If the test is saved (or data is saved) and later re-loaded, only the representation of the data which was in computer Data Memory will be available for view. If complete flexibility is desired to change between time and frequency domain views, zoom to the limits of the FFT or time sample resolution, perform FFTs of different portions of the record, etc., then the entire acquired waveform should be saved to disk by the File Save Waveform command so that it can later be down-loaded to the DSP via File Open Waveform and analysis continued.



# FFT Spectrum Analyzer

## General Purpose FFT spectrum analyzer (FFT)

FFT is a general-purpose waveform display and spectrum analyzer DSP program for System Two Cascade. It is usable for analog or digital domain input signals. FFT provides time domain (oscilloscope) display of waveforms or frequency domain (spectrum analyzer) display of signals up to 120 kHz. Features include pre-trigger to permit retention of a specified portion of signal prior to the occurrence of a trigger event. Signal buffer length for each channel is up to 256k samples, corresponding to signal duration of over five seconds at a 48 kHz sample rate. Selectable transform lengths from 256 samples to 32,768 samples are available to control the trade-off between acquisition and processing time versus frequency resolution of the resulting spectrum analysis. FFT provides the ability to position the start of the section to be transformed anywhere in the acquired record, including any pre-trigger section. FFT provides both spectrum averaging and synchronous (time domain) averaging. Both techniques improve the ability to measure low level or other noisy signals.

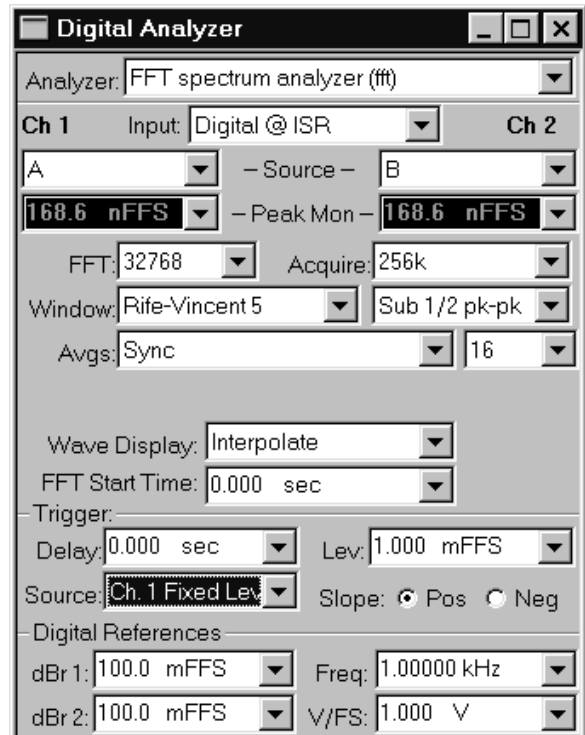

Figure 14-1 FFT Spectrum Analyzer Panel, Large Version

FFT has eight windowing functions. Several types of waveform processing are provided for optimum time domain displays.

## Input Source Selection

The General Purpose FFT Spectrum Analyzer can operate with either digital or analog domain input signals. The Input field near the top of the panel provides the following selections: **Digital**, **HiRes A/D @65536**, **HiBW A/D @131072**, **HiBW A/D @262144**, **HiRes A/D @OSR**, and **HiBW A/D @2xOSR**.

The “**Digital**” selection takes digital domain audio directly from the connector selected in the Input section (Format and connector selection radio buttons) of the Digital I/O Panel.

All the “**A/D**” selections choose the output of analog to digital converters fed from points following the input attenuators and balanced-to-unbalanced conversion circuitry of the two Analog Analyzer input channels. The Analog Analyzer’s autoranging circuitry or a fixed input range selection on the Analog Analyzer panel controls the audio signal level at this point. DC or AC coupling is controlled as discussed above.

The two “**HiRes A/D**” selections use 24-bit high resolution converters with optimum sample rate ranges up to about 100 kHz (bandwidth greater than 40 kHz). The “**HiBW A/D**” selections use 16-bit converters that operate to 262 kHz sample rates (bandwidth of 120 kHz), but with 10-15 dB poorer residual distortion.

The “**65536**, **131072**, and **262144**” selections provide A/D sampling rates at exactly 65,536 Hz, 131,072 Hz, and 262,144 Hz. Corresponding signal bandwidths are

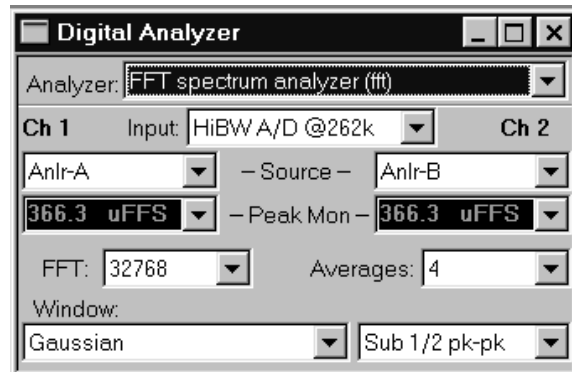

Figure 14-2 FFT Spectrum Analyzer Panel, Small Version

approximately 30 kHz, 60 kHz, and 120 kHz. These three sampling rates produce FFT bin widths that are even, integer numbers of Hz in width. For example, with an FFT (transform) length of 32,768 samples at the 65,536 Hz rate, bin widths will be exactly 2.000 Hz. The two “OSR” selections refer to the value in the Output “**Rate**” field of the DIO panel (labeled “**Sample Rate-OSR**” on the large version of the DIO panel). These OSR selections are furnished primarily for testing D/A converters in order to provide analog domain spectrum analysis matched to the digital input stimulus. With these selections, signal bandwidth will be approximately 40% of the selected sample rate value.

---

## Source

The selections available in the Channel 1 (left) and Channel 2 (right) Source fields depend upon the basic Digital/Analog selection in the Input field above.

When **Digital** is selected as Input, the Source field selections for both Channel 1 and Channel 2 are A, B, or None. **A** and **B** refer to the A and B channels of the two-channel digital signal. With normal stereo program material, A carries the left and B carries the right channel signal. The “**None**” selection disables acquisition of signal into the FFT acquisition buffer, thus preserving whatever signal was there previously. This permits acquisition of signals into the Ch 1 and Ch 2 buffers at two different times for comparison of different devices or the same device at different times.

When any of the A/D selections are made at Input, the Source field selections for both channels of the FFT analyzer are Anlr-A, Anlr-B, Anlr Reading Ampl, Anlr Reading Ratio, Ch. A Generator, Ch. B Generator, Jitter Signal, and None.

**Anlr A** and **B** are Analog Analyzer circuit points following all input ranging and balanced-to-unbalanced conversion, but prior to any filtering. These are essentially the same circuit points connected to System Two Cascade’s front-panel BNC connectors labeled Analyzer Signal Monitors, Channel A and Channel B.

**Anlr Rdg Ampl** and **Anlr Rdg Ratio** connect to the Analog Analyzer Function Reading meter, the final analog-processed signal before the detectors. This point follows all highpass, lowpass, and option filtering and follows the bandpass/bandreject filter. If the Function Reading meter is in either THD+N mode, the bandreject filter will attenuate the test signal fundamental sinewave to a low level. Up to 60 dB of additional gain is automatically added in the Function Reading meter, following the bandreject filter, under these circumstances. Distortion products and noise signals are thus fed to the A/D converters at levels typically 60 dB higher than normal, resulting in virtually no contribution of distortion from the A/D converters themselves. If the IMD analyzer or W&F analyzer options are present and selected, this point carries the output signal from those option boards. This is essentially the same circuit point connected to the front panel BNC connector labeled Analyzer Signal Monitors, Reading. The Anlr Reading **Ampl** selection furnishes absolute units such as Volts, dBV, and dBu with analog input and dBFS, FFS, and %FS with digital input. The Anlr Reading Ratio selection furnishes the %, dB, and X/Y units. The reference for these relative units is the Analog Analyzer Level meter when the Analog Analyzer Reading meter is set to THD+N, IMD, Ratio, and Crosstalk functions. If the Reading meter is set to W&F function, the reference is an internal calibration factor equal to 100% wow and flutter.

The Ch. A and Ch. B Generator selections connect the A/D input to the Analog Generator Channel A and B monitors, respectively. These are fixed-amplitude replica of the Analog Generator output waveform and are essentially identical to the front-panel BNC connectors labeled Generator Signal Monitors Channel A and Channel B.

The Jitter Signal selection connects the A/D input to the Digital Input/Output board signal proportional to the jitter of the incoming AES/EBU or Consumer signal. This permits spectrum analysis of the jitter.

As with Digital Input, the None selection disables acquisition of signal into the FFT acquisition buffer, thus preserving whatever signal was there previously. This permits acquisition of signals into the Ch 1



and Ch 2 buffers at two different times for comparison of different devices or the same device under different conditions.

---

## Peak Level Monitors

---

The Peak Mon reading fields on the FFT panel continually display the digital domain peak amplitude. Only digital domain units (FFS, dBFS, %FS, or bits) available for these meters.

The primary purpose of these Peak Monitors is to avoid overload of the A/D converters. When signal is being acquired from the Anlr A, Anlr B, Anlr Reading, or Gen Mon sources and Automatic Ranging is in use in the System Two Analog Analyzer, converter overrange should never be a problem. If any of the Analog Analyzer Range controls is fixed, it is the user's responsibility to see that the maximum signal amplitude never exceeds digital full scale.

---

## Transform Length

---

The transform length and sample rate determine the fundamental frequency resolution (bin width, or line spacing) of an FFT. Bin width equals sample rate divided by transform length. For example, with a sample rate of 131,072 Hz and an FFT length of 16,384 samples the resulting bin width is 8.000 Hz. Longer transform lengths thus produce greater frequency resolution in the FFT, but require longer times to acquire and to transform the signal. When the  function key or "Sweep Transform Data without Acquire" menu command is used to re-transform any portion of a record previously acquired, only the number of samples specified in the FFT field will be transformed.

To change the FFT transform length, click the down arrow at the end of the FFT field and select the desired value. Available selections are 256, 512, 1024, 2048, 4096, 8192, 16384, and 32768 samples.





---

## Acquisition Buffer Length

---

When either  or Go is initiated to acquire and transform, the FFT analyzer program can acquire either an amount of data exactly corresponding to the present FFT (transform length) setting, or can

acquire specific longer amounts up to 256k (262,144) samples. The “Track FFT” selection in the Acquire field causes only the amount of data equal to the present FFT field setting to be acquired. Acquisitions will thus be the fastest possible for any given resolution, but there will be no “surplus” data samples to be analyzed by changing the Start Time. The remaining selections from 800 samples through 256k cause the specific stated value to be acquired. When the signal acquired is longer than the FFT length used, FFTs may then be performed at different points throughout the record to profile the spectral content across the entire buffer.

After the initial acquisition and transform (Go), re-transformation may be made of another portion of the acquired signal. Specify a new value for FFT Start Time, change the FFT Length, and press the  key or use the Sweep Transform Data without Acquire command. Transformation begins with the sample at the time value in the FFT Start Time field and extends through the number of samples selected in the FFT (length) field. The full acquired signal remains in memory until the next acquisition () , a change in DSP program, or turning off power to System Two Cascade. If a negative value was entered in the Pre-Trigger Time field before  was pressed, the portion selected by the FFT Start Time field can extend back into the pre-trigger portion of the record by entering a negative value in the FFT Start Time field.

Any portion of the acquired signal may be viewed in the time domain by selecting the desired Start and Stop values at Source 1 on the Sweep panel when Source 1 is FFT Time.

## Window Selection

See the FFT Windowing Concepts section of the FFT-Based DSP Programs chapter for basic conceptual information on windows. The available window selections for FFT are Blackman-Harris, Hann, Flat-top, Equiripple, None, None, move to bin center, Hamming, Gaussian, Rife-Vincent 4, and Rife-Vincent 5. Each available window function has a different set of trade-offs in effective selectivity (signal spillover into nearby FFT bins) and in amplitude measurement error if the signal does not fall at an exact bin center frequency. See Figures

14-3 and Figure 14-4 for comparison close-in selectivity curves of the window selections of FFT. The figures compare the windows using a digital domain signal, where the lower noise levels permit better examination of the rejection characteristics and side lobes of the windows. The Hamming and Hann windows have the best selectivity near the top but limited rejection of more-distant signals. The Blackman-Harris, Equiripple, and Rife-Vincent windows have much better rejection of more distant signals. The Flat-Top window has the poorest selectivity, but virtually no amplitude error across the center three bins. Each available window selection is discussed below.

To select a window, click on the down arrow at the end of the Window box and click on the desired windowing function. Note that the window function is applied after signal acquisition and before the actual FFT transform. It is thus simple to change FFT Window selections and re-transform the data with the **F6** key, without making another acquisition. With the Append box on the Sweep panel checked, FFTs of the same signal with several different window functions applied can be graphically compared.

## Hann Window

The Hann window is a raised cosine window named after its

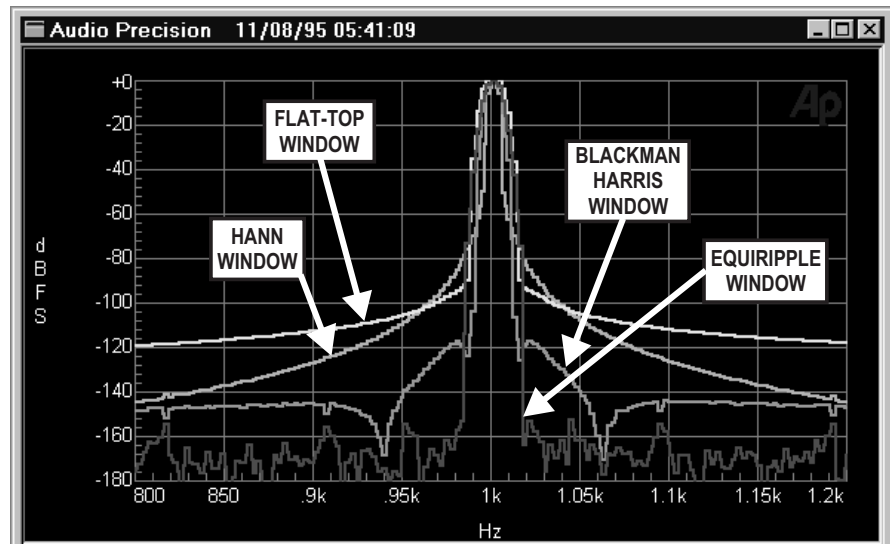

Figure 14-3 Available Window Functions, FFT

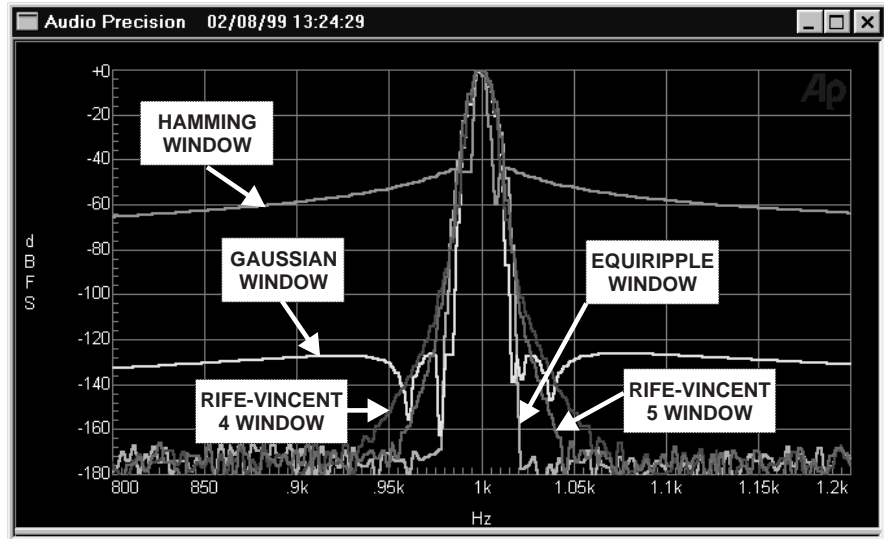

Figure 14-4 Additional Window Functions Available with System Two Cascade, FFT; Equiripple Shown in Both Figures for Comparison

inventor, Austrian meteorologist Julius von Hann. It provides good selectivity near the top (about 6 dB down one bin away from center and about 30 dB down two bins away), with no side lobes. Its skirts more than 3 bins off center are not as steep as the Blackman-Harris window. The Hann window causes approximately -1.5 dB maximum amplitude error due to window attenuation if the signal is at the extreme edge of the bin.

### Blackman Harris Window

The Blackman-Harris 4-term minimum sidelobe window was developed by R.B. Blackman and F.J. Harris. Compared to the Hann window, it is not quite as selective across the central several bins (about 3 dB down in the adjacent bins and about 14 dB down two bins off), but has steeper skirts beyond that point. The Blackman-Harris window has sidelobes below -92 dB (response fall-off is not monotonic). It has a reasonably flat top with a maximum amplitude error of about -0.8 dB if the signal is at the extreme edge of the bin.

### Flat-Top Window

The Flat-Top window is designed for the greatest amplitude measurement accuracy. It provides a maximum amplitude error due

to window attenuation of less than 0.02 dB even if the signal is at the extreme end of the bin. However, its selectivity is poorer than the other windows furnished. The Flat-Top window is the appropriate window for accurate amplitude measurements (such as when measuring individual harmonics) except when signals are so closely spaced that its selectivity becomes a problem.

### **Equiripple Window**

---

The Equiripple window, developed at Audio Precision, is an approximation to the Dolph-Chebyshev window that has the narrowest main lobe width for a given maximum sidelobe depth. The main lobe is approximately 12 bins wide; that is, the first null is about six bins from the main lobe center. The first sidelobe, which is also the highest sidelobe, is 147 dB down from the main lobe. The maximum amplitude error with a signal at the bin boundary is about 0.5 dB.

### **Hamming Window**

---

The Hamming window has the sharpest “nose” selectivity of all the furnished windows. Adjacent bins average about 7 dB down and two bins away the response is about 40 dB down. Amplitude error is about -1.7 dB for a signal at the extreme edge of a bin. The Hamming window has side lobes (that is, response fall-off is not monotonic) starting only 40-50 dB below the center bin, or about 4 bins away from center.

### **Gaussian Window**

---

The Gaussian window “nose” selectivity is only slightly wider than the Blackman Harris window and the near-by rejection is considerably better than Blackman Harris, reaching an average of 100 dB down in the fifth bin away from center. The side lobes are down more than 130 dB, compared to about -100 dB for Blackman Harris. Maximum amplitude error is about -0.7 dB for a signal at bin edge.

### **Rife-Vincent Windows**

---

Both Rife-Vincent windows have smooth, monotonically-falling responses with no sidelobes. The Rife-Vincent 4 window has about -0.6 dB maximum amplitude error, is down about -100 dB 7 bins off and about -150 dB 15 bins off. The Rife-Vincent 5 is slightly wider at

the “nose”, with about -0.5 dB maximum amplitude error with a signal at bin edge. It has sharper “skirts” with attenuation reaching about 106 dB 7 bins off and about 150 dB 12 bins off.

### **None (No Window, Rectangular)**

---

The “None” choice does not apply any window function before the FFT. It is sometimes called a rectangular window. This mode is normally used only with synchronous signals. It is not generally useful for non-synchronous signals since energy will appear to be spread across the entire spectrum unless the signal is exactly at bin center. The amplitude error due to window attenuation is about 4 dB when the signal is at the extreme edge of a bin.

### **None, move to bin center (Synchronous FFT of Non-Synchronous Sinewave)**

---

The fundamental mathematics of a Fast Fourier transform assume that the length of the transform buffer is synchronous with the signal. A synchronous condition means that every frequency component has an exact integer number of cycles in the transform buffer, so that if the buffer were spliced end-to-beginning, a continuous signal without transients would result. An FFT of a synchronous signal requires no windowing and thus furnishes the full selectivity and resolution theoretically available from the FFT. However, signals acquired from analog sources or “non-cooperating” digital sources are very rarely synchronous. Thus, most FFTs are performed only after applying a windowing function to the time domain signal. The windowing function removes the gross transients but causes signal to spread across a number of FFT bins centered on the signal center frequency, and causes gain error. Signals are typically spread across seven to nine bins by a window function, which greatly reduces the ability of an FFT of any given length to resolve closely-spaced signals.

The FFT Spectrum Analyzer program FFT provides a selection “None, move to bin center” (formerly called None, sync to sine) in the “Window” field. This selection is designed for use with single sinewave signals. Following F9 or Go and acquisition of a sinewave signal, the frequency of the acquired signal in DSP memory is measured. A frequency error correction technique is then applied to shift the

frequency of the signal in the acquisition buffer to the nearest exact FFT bin center frequency. This may also be thought of as stretching or compressing the waveform record to the nearest length which results in an exact integer number of complete waveform cycles in the buffer. The FFT is then performed, using no window. The result is excellent selectivity, with signal spreading to the adjacent FFT bin normally 120 dB down or more. Due to the correction, the signal in the DSP buffer will now be at an exact bin center and thus no longer be at the original frequency.

For example, assume that it is desired to test an A/D converter operating at a 48.00 kHz sample rate, using a test signal frequency of 997 Hz. This frequency is desirable since it is quite non-synchronous with the sample rate and thus exercises the converter through a large number of its possible states. Assuming an FFT transform buffer of 16,384 samples, the two nearest synchronous frequencies are 996.09375 Hz (exactly 340 cycles in the buffer) and 999.0234375 Hz (exactly 341 cycles). The “None, move to bin center” mode of the FFT program will shift the frequency of the acquired 997 Hz signal in DSP memory to 996.09375 Hz as the nearest synchronous frequency and then perform a window-less FFT. The A/D converter under test was thus exercised at the desired 997 Hz frequency, but the frequency correction yielded a result as if the signal had been at the synchronous frequency of 996.09375 Hz.

Note: if a signal is present only on one input channel, the unused channel Source field should be set to “None”. If this is not done, the frequency correction mechanism will display an error message when it fails to find a sinewave signal of significant amplitude.

The frequency correction technique has a maximum correction range of about  $\pm 3.0\%$ . Assuming a 16,384-sample transform and 48 kHz rate, this sets approximately 50 Hz as the lower limit above which a sinewave at any arbitrary frequency can be guaranteed to be brought to a synchronous frequency. The technique will work at still lower frequencies if the actual signal frequency is within 3.0% of a synchronous frequency. Assuming a 16,384 sample transform, bin centers may be computed from the equation  $f = (N * \text{Sample Rate}) / 16384$  where N is an integer. For example, with  $N = 7$  (exactly seven complete cycles in the FFT buffer) and a 48 kHz rate, the synchronous

frequency is 20.5078125 Hz. A  $\pm 3.0\%$  range around that frequency extends from approximately 19.9 Hz to 21.1 Hz and a sinewave anywhere within that range will be corrected to the synchronous frequency.

Note that the window function is applied after signal acquisition and before the actual FFT transform. It is thus simple to change FFT Window selections and re-transform the data with the  key, without making another acquisition. With the Append box on the Sweep panel checked, FFTs of the same signal with several different window functions applied can be graphically compared. However, any frequency error correction accomplished by the “None, move to bin center” selection of FFT will be performed only once.

## Dynamic Range

---

FFT uses 48-bit (double precision) mathematics, resulting in a dynamic range greater than 140 dB, except when analyzing the jitter signal or when using the HiBW A/D converters. 24-bit single precision mathematics are used for jitter, all sources with the HiBW converters, and in the other FFT-based programs (FASTTEST, MLS). The 24-bit math results in an effective dynamic range of about 108 dB between the strongest signal present and the level where amplitude measurement errors may approach one decibel on weaker signals. The inherent noise and distortion in the jitter signal and the High BW converters do not warrant the use of double precision FFT computations.

## Quasi AC Coupling

---

FFT can be DC-coupled to the input signal or can operate in one of two modes of quasi-AC coupling. The field at the right of the Windows selection field offers three choices: DC Coupled, Subtract Avg, Subtract 1/2 pk-pk. When “Subtract Avg” is selected, the DSP computes the average value of all samples in the acquisition buffer and subtracts that computed value from the value of each sample before an FFT transform or waveform display. The “Subtract 1/2 pk-pk” selection computes the maximum difference between positive and negative peak values in the acquisition buffer and subtracts half that amount from each sample before transform or wave display. The



general effect of either of these selections is thus similar to having used AC coupling before acquiring the signal, as long as no signal peaks exceeded digital full scale. Use of either quasi-AC coupling function may be valuable when examining low-level signals which contain a significant amount of DC offset, particularly in time domain (oscilloscope) presentations where the DC offset might otherwise cause the signal to be off-screen at the selected vertical span. The “Subtract 1/2 pk-pk” selection generally results in less DC remaining than the “Subtract Avg” selection. Note that either selection may introduce DC error, particularly on very low frequency signals.

This quasi-AC coupling occurs before Triggering, so the selection is also important when attempting to trigger on a low-level portion of a signal. In the synchronous averaging mode, the DSP must find a zero crossing in order to align waveforms in time for averaging. If the waveform contains enough dc there will be no zero crossings. The user can remove this dc before averaging, thereby producing zero crossings which will allow alignment. The “Subtract Avg” mode may introduce error on low frequency signals that would be a significant problem in the DSP finding zero crossing locations. For well behaved signals the “Subtract 1/2 pk-pk” function should produce acceptable results.

## Averaging

The FFT spectrum analyzer provides two fundamentally different averaging techniques for better ability to measure program material and noise, or low-level and other noisy signals. These are power (spectrum) averaging and synchronous averaging. Both operate by acquiring a signal, storing that signal (or a processed version) into DSP memory, acquiring again and adding the new signal (or a processed version) to the previous acquisitions, etc. Both go through this process for the number of successive acquisitions specified by the user. Both ultimately divide the accumulated result by the number of acquisitions in order to scale it back to the correct amplitude. They differ in that spectrum averaging operates only on the frequency domain result (spectrum analysis) after each FFT is performed, while synchronous averaging operates on the time domain signal and is therefore useful both for time domain and frequency domain analysis. Averaging

factors from 2 to 4096 are available. A selection of “1” disables averaging. During an averaging process, the the Status Bar at the lower left of the screen displays in count-down fashion the remaining number of averages still to be acquired.



Figure 14-5 FFT Averages Counter on Status Bar

## Spectrum (Power) Averaging

The primary purpose of spectrum averaging is to provide a more accurate measurement of the amplitude versus frequency characteristics of varying signals. Spectrum averaging is selectable in the field to the right of the “Avg’s” label as “Power (spectrum only)”. It operates only on the frequency domain (amplitude vs. frequency) results following an FFT. It will not operate if a time domain display (FFT Time at Source 1) has been selected. If a time domain view is selected following a spectrum averaging process, the **CTRL** **F6** keystroke (rather than **F6**) must be used to view the time domain data and only the last acquisition of the series of averaged acquisitions will be viewed. Averaging over many seconds or minutes of noise or of program material such as music or voice is very useful in order to determine the long-term average amplitude versus frequency distribution. Power law averaging (root-mean-square) is used by FFT to correctly average noise signals.

Coherent (steady, continuous) signals will be unaffected by Power (spectrum) averaging. Variable signals such as noise and program material will converge to their average values at each frequency as the averaging factor is increased. The result is that the peak-to-peak variance in the displayed noise floor or program material is reduced while coherent signal amplitudes are unchanged. The average level of the noise floor is not changed. Figure 14-6 shows the fft of a low amplitude signal without averaging. Figure 14-7 shows the same signal after 128x Spectrum averaging. Note that the average level of the noise is about -160 dBV in either case, but the peak-to-peak variance in the noise has been reduced by the averaging. The slight rise in noise levels at high frequency due to noise-shaped dither is visible in the averaged result but not on any single acquisition and FFT.

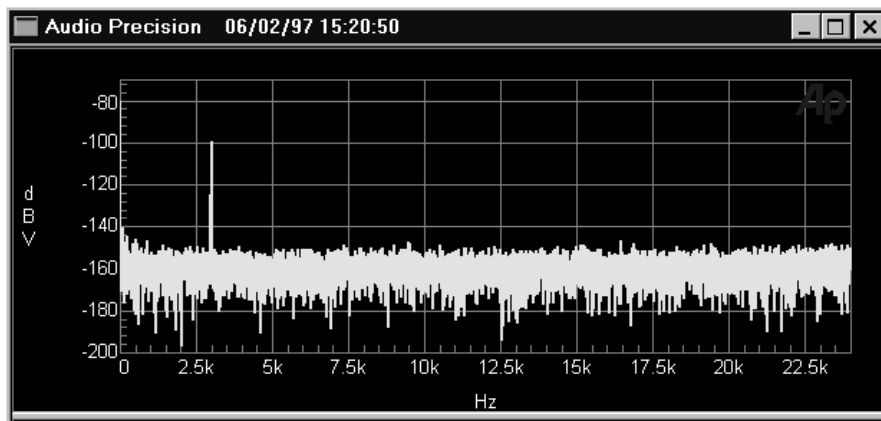

Figure 14-6 Low Level Signal, No Averaging

Coherent signals very near the noise floor, such as the distortion product at 9 kHz in the figure, may become visible as the noise converges to its average value.

## Synchronous Averaging

The primary purpose of synchronous averaging is to reduce noise levels in order to provide more accurate measurements of signals which would otherwise be lost in the noise. Synchronous averaging is performed on the acquired (time domain) signal, before any FFT transform. Synchronous averaging is useful even when an FFT is not desired. For most selections in the Window field, synchronous

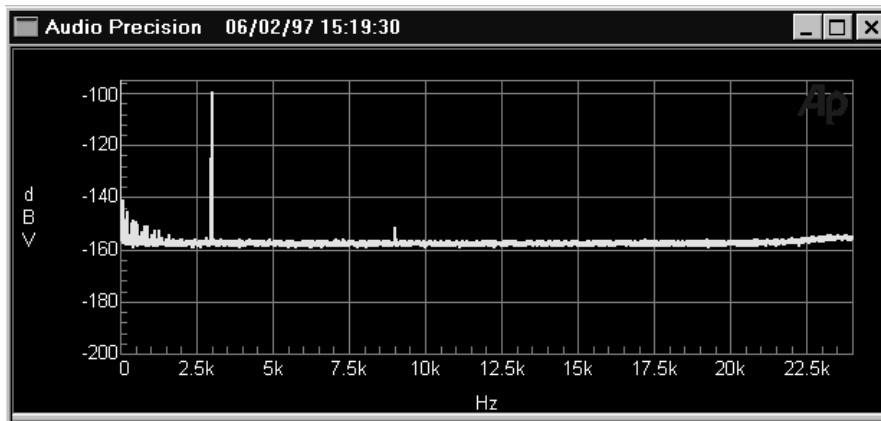

Figure 14-7 Same Low Level Signal, 128x Power (Spectrum only) Averaging. Noise Variance is Reduced, No Change in Average Noise Level

averaging is selected by either the “Sync” or the “Sync, re-align” choices in the Avgs field. If the Window selection is “None, move to bin center”, there are four synchronous averaging choices in the Avgs field: “Sync, re-align, move center first”, “Sync, re-align, average first”, “Sync, move center first”, and “Sync, average first”.

In order for the amplitude of coherent signals to be preserved during synchronous averaging, each new acquisition must be accurately time-aligned with the previous acquisitions before it is added to the accumulating signal in DSP memory. This time alignment may be accomplished by proper triggering at acquisition, or by a DSP re-alignment process. The “Sync” (synchronous) selections without the “re-align” assume that the triggering selections on the FFT panel are sufficient to cause each acquisition to start at the same relative point on the waveform. The “Sync, re-align” choices select the second technique. With “re-align”, signal is acquired with any triggering selection, including Free-running (untriggered). The DSP then slides the signal forwards or backwards in time until it is aligned with the sum of already-accumulated signals.

With “None, move to bin center” in the Window field, the two “average first” selections will provide the fastest operation since the “sync to sine” operation is only done once, following all acquisitions and averaging. The “move center first” selections perform the “sync to sine” operation at each acquisition and thus slow overall measurement time. However, if the signal frequency changes from acquisition to acquisition due to flutter or drift, the “move center first” selections may provide more accurate measurements. Frequency changes during synchronous averaging will result in amplitude errors since the signals will not be time-aligned at the end of the buffer even if synchronized at their initial zero crossing.

The final averaged result will start at the value in the Delay field and continue from that point for the Length value. Any signal before and after is erased. For example, if “8192” is selected in the FFT field and 100 milliseconds is entered in the Delay field (assuming that the Acquire field value is sufficiently long to contain 100 milliseconds plus 8192 samples), the final averaged result will start at 100 ms and continue for a bit more than 8192 samples beyond that point (to approximately 271 milliseconds at a 48 kHz sample rate). Time

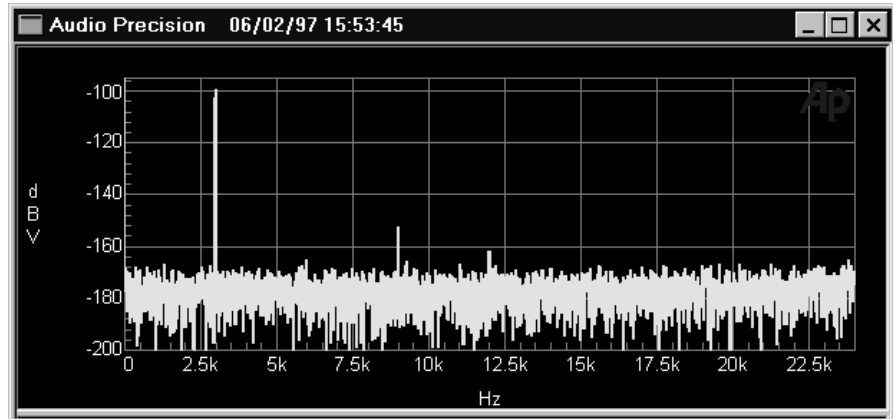

Figure 14-8 Same Low Level Signal, 128x Synchronous (Time Domain) Averaging. Average Noise Level is Reduced, No Change in Noise Variance

domain view or FFT transforms may then be made anywhere within that 8192 samples.

An FFT of a synchronously-sampled signal will be correct only if the signal transformed, as determined by FFT Start Time and Length, lies completely within the occupied portion of the buffer. In the example above, any FFT Start Time less than 100 milliseconds would produce erroneous data. Any combination of Start Time and Length extending beyond the 271 millisecond point would also produce bad data.

With synchronous averaging and time alignment via proper triggering or the “Sync, re-align” mode, coherent signals will be unchanged by the averaging process. The average value of noise signals will be reduced by 3 dB for each doubling of the averaging factor. Figure 14-8 shows the same signal conditions as the previous two figures with 128x synchronous averaging. Note that the peak-to-peak variance of the noise is still approximately as it was with no averaging, but the average level of the noise is now approximately -180 dBV. A 128x synchronous averaging factor would theoretically be expected to produce a 21 dB reduction in the noise floor. In addition to the 9 kHz distortion product, another is visible at 12 kHz and the hint of another shows at 6 kHz.

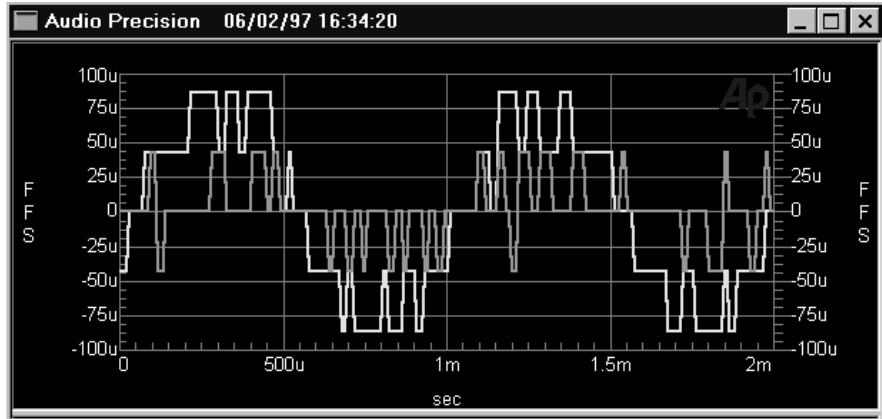

Figure 14-9 -85 dBFS and -100 dBFS 16-bit sinewave signals, normal dither, no averaging.

As noted earlier, synchronous averaging is also useful when viewing noisy signals in the time domain. Figure 14-9 shows a time domain display of -85 dBFS and -100 dBFS 16-bit sinewave signals with normal triangular dither and no averaging. All that can really be seen is that one signal occupies the five lowest-amplitude digital codes and the other occupies the three lowest codes. Figure 14-10 is the same signal with 256x synchronous averaging, triggered from the digital generator. The sinusoidal waveform is now clearly visible.

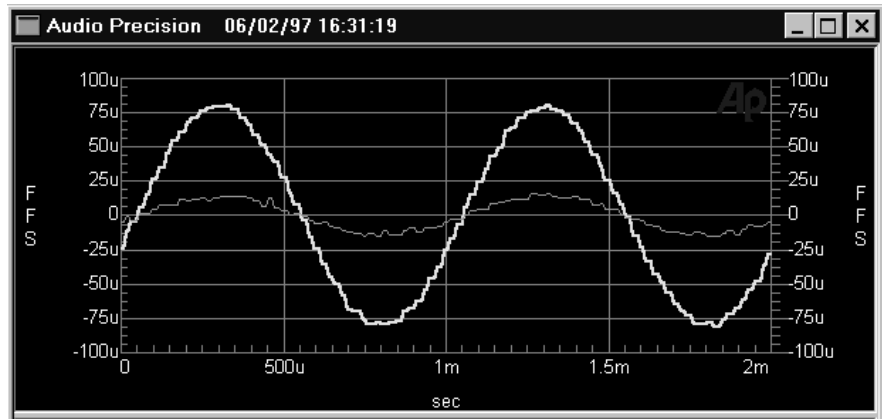

Figure 14-10 -85 dBFS and -100 dBFS 16-bit sinewave signals, normal dither, 256x synchronous averaging, DGen triggering

## Triggering with Synchronous Averaging

If synchronous averaging without re-align mode is used, proper triggering is absolutely essential. Random, untriggered acquisitions will not be aligned in time, resulting in cancellation of coherent signals and large amplitude errors. In stimulus-response testing from System Two Cascade, either the Analog Gen or Digital Gen (as appropriate) trigger sources on the FFT panel should be used. If an external signal is presented from another signal source, one of the Ch 1 or Ch 2 selections should be used as trigger source. If signals are being acquired on both channels, they must be at the same frequency or must have harmonically-related frequencies when re-align mode is not used. Sync without re-align will properly measure only signals harmonically related to the trigger source. Signals whose frequency is not related to the trigger source may have large amplitude errors or may entirely disappear.

## Re-alignment

The “re-align” mode first acquires signal according to whatever triggering selections are in use, interpolates the acquired signal between the actual sample values, locates the first positive-going zero crossing in the interpolated data, time-aligns that with the first zero crossing in the accumulated record, and adds the signal from that point onwards into the averaging buffer. This process is carried out after each of the series of acquisitions to be averaged, resulting in precise time alignment. Triggering is not critically important in this mode if the signal is not noisy and the signal repetition rate is relatively high, since the necessary alignment takes place in the DSP buffer after Acquisition. Noisy signals may not be correctly aligned by this mode, resulting in amplitude error. The primary disadvantage of the re-align mode is the additional time taken by the DSP to do the operation after each acquisition.

The re-align mode works independently on each channel. If the two channels carry different frequency signals, “re-align” mode thus must be used.

The re-align mode should be used for accurate amplitude measurements on all signals above about ten percent of sample rate.

Without realignment, the random time relationship between the signal itself and System Two Cascade's sample clock will cause random misalignment up to one-half clock period, resulting in partial cancellation that becomes significant at high frequencies. Realignment works with interpolated versions of the signal and thus aligns accurately, for accurate amplitude measurements, even at high frequencies.

## Waveform Display Processing

Four modes are available in FFT for processing the amplitude-versus-time relationship of a sampled signal before displaying the waveform. These modes are applicable only to “digital storage oscilloscope” operation (amplitude versus time graphs) and have no effect on FFT spectrum analysis.

The four modes available in the “Wave Display” (Waveform Display) field are Interpolate, Display Samples, Peak Values, and Absolute Values. To change Waveform Display modes, click on the down arrow at the end of the Wave Display field and click on the desired selection. The Wave Display field is visible only on the large version of the Digital Analyzer panel.

When Interpolate is selected, the DSP module will perform an interpolation calculation based on the assumption that the signal was band-limited by a low-pass filter before sampling. The Interpolate selection produces a much more accurate display of the signal waveform when the signal frequency is high (such as sample rate/100 or higher).

When Display Samples is selected, no processing takes place in the DSP module. At each time value plotted on the X-axis, the DSP simply sends the amplitude of the nearest-in-time acquired sample to the computer for plotting. When the signal frequency is low compared to the sample rate, this may produce an acceptable representation of the original signal waveform. At high signal frequencies, the waveform may be entirely unrecognizable in the Display Samples mode. For example, a 16 kHz sinewave acquired at the 48 kHz sample rate will have each cycle of waveform represented by only three amplitude



samples and the result will look very little like a sinewave. The Display Samples mode may be useful when examining the true, quantization-limited waveforms of low amplitude digital signals.

When Peak Values is selected, the DSP searches all sample amplitudes in the acquisition buffer between each pair of X-axis time values plotted and sends to the computer for plotting the largest positive or negative value in that span, preserving the plus or minus sign. The intended use of the Peak Values mode is when graphing a relatively long time span on the X-axis, where the combination of Start-to-Stop time span and Steps value on the Sweep panel results in skipping across many actual acquired samples between plotted points. For example, assume a signal is acquired at the 48 kHz sample rate (20.8 microseconds between samples). If the waveform of that signal is being viewed from 0 to 200 milliseconds with 400 steps, the time span between plotted points on the graph X-axis is 0.5 milliseconds (500 microseconds). There are approximately 24 samples between plotted points. If Peak Values or Absolute Values modes are not used, an unfortunate combination of signal frequency, X-axis span, and Points value can make it appear that no waveform, a near-DC signal, or a waveform at a completely different frequency is present (see the Graphic Aliasing section on page 13-4). Since Peak Values searches through all sample values within each span between plotted points and sends the largest value to be plotted, signals cannot be missed.

When Absolute Values mode is selected, the DSP searches all sample amplitudes in each plotted-point-to-plotted-point span as it does in Peak Values mode, but takes the absolute value of the largest positive or negative value and thus always sends a positive number to the computer. The advantage of Absolute Values mode is that logarithms may be computed when all numbers involved are positive, so a dB units may be used on the Y axis to display the waveform. Waveform display with Absolute Values mode thus can create a wide dynamic range oscilloscope which displays the envelope of an audio signal, calibrated in familiar dB units such as dBV, dBm, dBu, etc. Absolute Values mode is most effective when the X-axis span and Points values are selected to produce approximately two plotted points per cycle of the waveform being plotted. For example, if an envelope display of tone burst waveforms of a 1 kHz signal (1 millisecond



period) are being plotted across a 50 millisecond span, the Points value on the Sweep panel should be set to approximately 100.

---

## Start Time

FFT permits the user to select any point in the acquired signal record as the beginning of the portion to be transformed. The FFT transform is then computed for the contiguous section of samples starting at that sample and continuing for the number of samples chosen in the Length field. FFT thus permits selective spectrum analysis of different sections of a complex signal such as program material or special test signals such as sinewave bursts.

To change the value of Start Time, click in the field and type in a new number from the keyboard. The acceptable range of numbers depends upon the sample Rate set on the Digital I/O panel, since the acquisition buffer is a fixed length in samples. At a 48 kHz sample rate, for example, the Start Time field will accept numbers between plus and minus 341 milliseconds.

If the original signal acquisition () was made with a negative value in the Pre-trigger Time field, negative values up to and including that same value may be used as FFT Start Time values to permit spectrum analysis of the pre-trigger section of the acquired record. A common example is when using the Analog Generator's BUR option sinewave burst signal as test stimulus to some dynamic processor such as a compressor or limiter. In this example, signal acquisition into FFT is triggered from the tone burst signal (see the Trigger Source topic). A negative value entered in the Pre-Trigger Time field causes the acquired signal following  to consist of time before and after the trigger event. Setting FFT Start Time to a negative value will then position the starting point of the section to be transformed before the trigger at the burst beginning, permitting spectrum analysis during the attack time of the processor.

---

## Delay (Pre-Trigger) Time

FFT has the ability to fill the acquisition buffer with signal samples starting at a user-defined time before or after the trigger occurs, then

continuing until the buffer is full. This permits analysis of signal conditions both before and after the triggering event. A negative value entered in the Delay field determines how much time (and thus how many samples) prior to the trigger event are retained. The Delay field is visible only on the large form of the FFT panel. The total length of signal acquired will be as defined in the Length field, with the remainder of the acquisition buffer filled after the trigger. For example, with the “24k” Acquire field value the length of the acquisition buffer for each channel is 512 milliseconds at a 48 kHz rate. If the Delay time value is -50 milliseconds, for example, then 462 additional milliseconds of signal following the trigger will also be acquired to fill the entire 512 ms buffer.

Pre-trigger data is acquired in this fashion: when the  key is pressed or Go is clicked, FFT and the DSP module immediately begin acquiring data samples, even though no trigger event may have yet occurred. If the acquisition buffer should completely fill before a trigger event occurs, data continues to be acquired in a FIFO (first in first out) basis with the oldest data being dropped as new data is added. When the trigger event occurs, FFT effectively creates a marker at that location (time zero) and another marker at the pre-trigger time before time zero while continuing to acquire until every location up to the pre-trigger marker is filled. Any portion starting from the pre-trigger time through time zero to the end of the record may then be displayed in oscilloscope fashion or transformed and viewed as a spectrum analysis.

## Acquisition Triggering Section

The Acquisition Triggering section of FFT consists of the Source field, Sens (sensitivity) or Lev (level) field for certain Source selections, and the Slope “radio buttons” (Positive/Negative). Acquisition of signal into the FFT acquisition buffer may start immediately when  is pressed or Go is clicked, or may wait for a trigger event, depending upon the setting of the Source field. The Source and Sens/Lev fields and Slope buttons are visible only on the large version of the Digital Analyzer panel.

To change triggering source selections, click on the down arrow at the end of the Source box, then click on the desired selection. The selections are Free Run, Ch 1 Auto, Ch 1 Fixed Sens, Ch 2 Auto, Ch 2 Fixed Sens, External, Digital Gen, Analog Gen, AC Mains, Jitter Gen, Ch 1 Fixed Lev, and Ch 2 Fixed Lev.

When Free Run is selected, signal acquisition begins immediately after  or Go is initiated, regardless of signal amplitude. This is the typical operating mode with steady-state test signals.

The six Channel 1 and Channel 2 selections are software triggers, monitoring the signal (which may come from Digital or A/D sources) on the specified channel.

### Fixed Sensitivity

---

Ch 1 Fixed Sens and Ch 2 Fixed Sens use the value set in the Sens (sensitivity) field as the triggering threshold. The Sens field appears only when one of these two selections is made. FFT will trigger on the first zero crossing of the selected slope (Positive or Negative “radio button”) after the signal amplitude is sufficient to swing both through zero and the “Sens” value. If the signal contains sufficient DC offset that it does not swing through zero, no triggering will take place. In this case, use one of the quasi-AC coupling modes (Subtract Avg or Sub 1/2 pk-pk) which will cause the processed signal to pass through zero and permit triggering to function. The Ch 1 Auto and Ch 2 Auto selections will cause triggering at one-half the peak-to-peak value if the selected channel has a signal amplitude greater than digital “infinity zero”.

### Fixed Level

---

The Ch 1 Fixed Lev and Ch 2 Fixed Lev fields operate identically to conventional oscilloscope triggering. A “Lev:” numeric entry field is displayed when either of these trigger selections is chosen. Positive or negative values may be entered into this field. An acquisition will be triggered the first time the signal with the specified slope (Positive or Negative) passes through this level. Note that the values in this field

The Digital Generator selection functions only on units with digital output capability (SYS-2522, SYS-2500). If the digital generator is

generating any of the waveforms selectable in the Waveform field, a Digital Generator trigger occurs at each zero crossing of the waveform, positive-going or negative-going as selected by the Slope buttons. If the Digital Generator is generating a signal from a waveform file, a Digital Generator trigger occurs as the first sample is read from the waveform file.

The AC Mains selection is the AC line powering System Two Cascade.

The Analog Generator selection is the same signal as at the Generator Aux Signals Sync Output BNC on the front panel of System Two Cascade. This signal is:

- a squarewave at the analog generator frequency in sinewave and squarewave waveforms
- the envelope of the burst signal in all Burst waveforms
- a squarewave at the lower IMD frequency in SMPTE/DIN IMD waveform
- a squarewave at 1/2 the frequency spacing in CCIF/DFD IMD waveform
- the squarewave IMD signal in DIM IMD waveform
- a pulse at the pseudo-random repetition rate in Pseudo noise modes
- a pulse whenever the waveform touches the maximum possible negative value in Random noise modes.

The External selection refers to the EXT TRIGGER IN BNC connector on the rear of the DSP module. This source is operational only with SYS-2522 and SYS-2500 units. The trigger circuitry is edge-sensitive, and FFT will trigger on a positive-going or negative-going edge on the signal at this connector, depending upon the setting of the Slope buttons on the FFT panel.

The Jitter Generator selection provides a trigger at each cycle of the waveform selected in the Jitter Generation section on the large form of the Digital I/O panel. This provides stable viewing of jitter waveforms generated by System Two Cascade.

The triggering Slope controls are two “radio buttons” labeled Positive and Negative. Selecting Positive causes triggering to occur on a positive-going portion of the signal selected, while Negative causes triggering on a negative-going waveform.

---

## Digital References

---

The bottom section of the large version of the Digital Analyzer panel with the FFT analyzer selected includes four reference values.

The dBr1 and dBr2 values serve as the reference for the dBr1 and dBr 2 units selectable at the Data 1 through Data 6 areas of the Sweep panel. The dBr1 and dBr2 references on the FFT panel may be entered in either analog or digital domain.

The V/FS value is the analog-to-digital scaling value. When testing an external Analog to Digital converter (A/D), the value of analog input voltage that produces digital full-scale output may be typed into this field. The Data 1 through Data 6 units may then be selected as V, Vp, Vpp, dBu, or dBV to express the measured digital amplitude in terms of the analog input value to the A/D converter under test.

The Frequency value serves as the reference for the relative frequency units (octaves, decades, %Hz, etc) selectable at the Source 1 area when FFT is the Instrument and FFT Freq is the selected Parameter in the Source 1 browser.

---

## Sweep Settings, Readings, and Units

---

When the FFT is selected on the Digital Analyzer panel and “Fft” selected in the Instrument column of the Source and Data Browsers, the following Parameter selections are available for sweeps:

Readings (for selection at Data 1 through Data 6 to be plotted as traces): Ch. 1 Ampl, Ch. 2 Ampl., Ch 1 Phase, and Ch 2 Phase. The units for Phase are degrees.

Amplitude Reading Units: when Digital input is selected on the DSP analyzer panel, the available readings units on the Sweep panel are FFS, %FS, dBFS, Bits, V, Vp, Vpp, dBu, dBV, dBr1, and dBr2. The FFS, %FS, dBFS, and Bits selections are the normal digital domain units. The V, Vp, Vpp, dBu, and dBV analog domain units all use the V/FS conversion factor at the bottom of the FFT analyzer panel. These analog domain units may be useful when testing A/D converters, by entering the full-scale analog input value for the converter under test. The dBr1 and dBr2 units refer to the zero dB reference values entered into the dBr1 and dBr2 Reference fields at the bottom of the Digital Analyzer panel. Normal usage is with dBr1 serving as the Channel 1 reference and dBr2 serving as Channel 2 reference, but this relationship is not required. The calibration of the dBr1 and dBr2 units refers directly to the dBr1 and dBr2 Reference values entered on the digital analyzer panel when those reference values are entered in digital domain units (FFS, dBFS, etc). If the values entered into the dBr1 and dBr2 Reference fields are in analog domain units (V, dBV, dBu, etc.), those analog domain reference values are converted to the digital domain via the V/FS Reference value on the FFT panel before being used as zero dB reference values.

When any A/D selection is made for Input and anything other than Anlr Reading Ratio or Jitter Signal is selected as the Source, the available readings units on the Sweep panel are V, dBu, dBV, dBr A, dBr B, dBg A, dBg B, dBm, and W (Watts). V, dBV, and dBu are absolute units with the standard definitions. The dBr A and dBr B units are with reference to the dBr A and dBr B Reference values on the Analog Analyzer panel. The dBg A and dBg B units are with reference to the current value of the Analog Generator Channel A and Channel B output amplitude fields. The dBm and Watts units are with reference to the dBm and Watts Reference impedance values on the Analog Analyzer panel.

With any A/D selection is made for Input and Anlr Reading Ratio is selected as Source, the available units are dB, %, and X/Y. These relative units are with respect to the reading of the Level meter of the

Analog Analyzer panel that is measuring the input channel selected on the Analog Analyzer Reading meter..

With A/D selected as Input and Jitter Signal selected as Source, the available units are UI (Unit Intervals) and dBUI (decibels relative to 1.000 UI).

Sweep panel Settings selections for FFT (for use at Source 1 as the independent, swept variable or Source 2 for nested sweeps) are: FFT Time, FFT Freq., FFT Pre-Trig Time, and FFT Start Time. When any of the three Time parameters are selected as the setting, the available units on the Sweep panel are seconds. When FFT Freq is selected as the setting, the available units are Hz plus all the variable frequency units (%Hz, octaves, PPM, etc.). The relative frequency units are all with respect to the value in the Frequency Reference field at the bottom of the digital analyzer panel.

---

## Saving and Loading Waveforms

---

Both channels of acquired waveform remain in the DSP Acquisition buffer until one of the following events:

-  (Go, Sweep Start, etc) is pressed to acquire new waveforms
- a different DSP program (or no DSP program) is loaded, by changing the “Analyzer” field contents on the Digital Analyzer panel
- power is turned off to System Two Cascade
- different waveforms are downloaded from disk as described in this section.

While the waveform is still present in the Acquisition buffer, full flexibility exists to change back and forth between time and frequency domain analysis (FFT Time vs. FFT Frequency at Source 1). You may view different time portions of the record, perform FFTs of different transform length, position the transform starting point at different places in the record, change window functions, change FFT post processing modes, change time domain processing modes, etc. The



results of any and all of these different modes of analysis may be saved one at a time, as .AT2C test files to disk. However, once the waveform is gone from DSP memory, no further ability exists to analyze the signal other than re-loading test files to look at the specific analyses which were saved. If full flexibility for continued analysis is desired, the acquired waveform itself may be saved to disk, rather than merely saving test files each of which represents one particular processed result of one type of analysis. The saved waveform can then later be downloaded to the DSP Acquisition buffers for further analysis. Single-channel waveforms saved at different times can later be individually loaded into the two channels of Acquisition buffer for comparison in the time or frequency domains.

## Saving Waveforms

Selected sections or the entire contents of the Acquisition buffers may be saved to a disk file by the File Save As menu command, selecting either the “Stereo Waveforms (\*.AAS)” or “Mono Waveform (\*.AAM)” as the Save As file type.

A Stereo Waveform file (.AAS) consists of two waveforms joined together into a single file. A Mono Waveform file (.AAM) contains a single waveform. To simultaneously save the waveforms from both Acquisition buffer channels, select the Stereo choice. To save only one of the channels, select Mono.

When the waveform file type is selected, a file name is typed in by the user, and the Save button is clicked, a dialog box as illustrated in Figure 14-11 will appear.

The left half of the dialog box defines what will be saved into the first section of a waveform file and the right half defines what will go

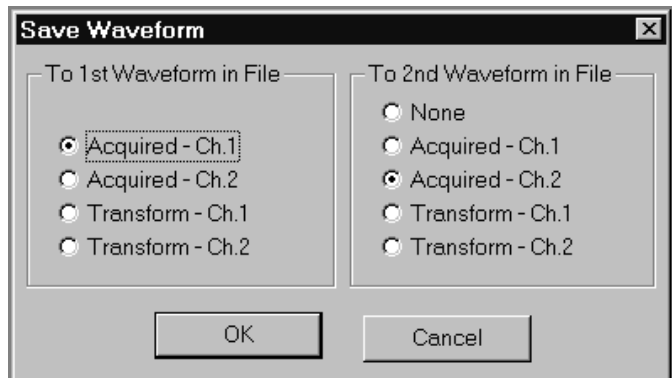



Figure 14-11 Save Waveform Dialog

into the second section.

### Full Acquisition Buffer vs. Transform Sub-Section

The choices in each section are None, Acquired-Ch 1, Acquired-Ch 2, Transform-Ch 1, and Transform-Ch 2. When saving a Mono file, the right half of the dialog is not applicable and will be gray. The “Acquired” choices will result in saving the entire contents of an Acquisition buffer to disk. The “Transform” choices result in saving only the sub-section of the Acquisition buffer specified by the Transform Length selection. If the Transform Length value has been reduced following acquisition, the “Transform” selection will be the shorter value presently specified in the transform field while the “Acquired” selection would save the entire length which had been acquired. The length of signal acquired is determined by the Acquire field setting when /Go is executed. When the “Transform” selection is chosen and the currently-selected transform length (FFT field) is less than the full buffer (for example, a 1024 sample transform out of a 72k sample acquisition buffer), the starting point of the section saved to disk is the sample corresponding to the FFT Start Time setting. If a smaller section of the waveform is sufficient for the intended future analysis purposes, use of the “Transform” selections can result in much smaller disk files than the “Acquired” selections. DSP memory width is 24 bits and computer disk files are organized around 8-bit bytes, so the length of a disk file is approximately three times the length of buffer it was saved from. One channel from a 19k-sample acquisition buffer will thus result in approximately a 57k file size, while use of the “Transform” selection with a selected Transform length of 1024 samples would result in about a 3k file size.

### One vs. Two Waveforms

The selections in the left half of the dialog box determine which buffer contents go into a Mono waveform file or into the first section of a Stereo waveform file. The contents of the second section of Stereo waveform files are defined by the settings of the right half of the dialog box. If a Mono waveform is being saved, the right half of the dialog will be gray. It is normally preferable for the two sections of a Stereo waveform file to contain records of the same length, so normally one

would not use the “Acquired” selection for one section and the “Transform” selection for the other.

## Combining Mono to Stereo

It is possible to save single channel waveforms acquired at two different times and then combine them into a Stereo waveform so that simultaneous time or frequency domain analysis may be made for some “before and after” conditions. Save a Mono waveform from the first set of conditions, specifying the channel number where the desired data is presently located. Under different test conditions or with a different device under test, save another Mono waveform with a different name. Use the Open Waveform feature described below to load one of these waveform files into the Ch 1 Acquisition buffer and the other into the Ch 2 Acquisition buffer. Then, use the Save As command, select Stereo waveform and supply a new file name, and select the Ch 1 waveform into the first section and Ch 2 into the second.

It is also possible to use the DOS Copy command to concatenate two Mono waveform files into a new Stereo file. The command (from the DOS prompt) is:



```
COPY /B FILENAME1.AAM + FILENAME2.AAM NEWFILE.AAS
```

## Loading (Opening) Waveforms

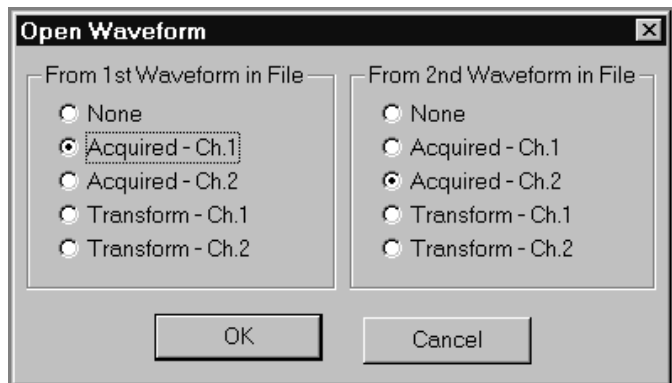
Existing waveform files may be downloaded from computer disk to the DSP via the File Open command with its subsidiary selections of Stereo Waveforms (.AAS) or Mono Waveforms (.AAM).



Selection of the *Figure 14-12 Open (Load) Waveform Dialog*

desired waveform file name (after navigating to the desired directory, if necessary) and clicking the Open button then displays the Open Waveform dialog box as illustrated in Figure 14-12. The left half selections determine which DSP buffer the first section of the waveform file will be loaded into. The right half of the dialog is gray when opening a Mono waveform. With a Stereo waveform, the right half defines which buffer the second section of the waveform file loads into. The “Acquired” and “Transform” selections work similarly to the Save Waveform operations described above. Clicking OK then actually downloads the waveform file contents. After the waveform is loaded, the  and  keys and settings on the Digital Analyzer panel and Sweep panel may be used as described earlier for continued analysis of the waveform.

If the downloaded file length is greater than the length of the specified buffer, an error warning will be displayed. If the downloaded file length is greater than the buffer size, the portion which fits in the buffer can be analyzed normally and the remainder cannot be viewed. FFT has a longer buffer than FASTTEST and so can completely view files saved from FASTTEST. FASTTEST will be able to accept only the first 32,768 samples of a full waveform file saved from FFT. If the downloaded file length is shorter than the buffer size, erroneous analysis will result if the selected Transform Length extends beyond the last data sample in the buffer. The contents may first be displayed in Time Domain mode to determine exactly where the signal ends.



# Multitone Audio Analyzer

The Multitone Audio Analyzer (FASTTEST) is an FFT-based analysis program furnished with System Two Cascade for use with both analog and digital audio signals.

## Multitone and Synchronous FFT Concepts

Multitone testing with synchronous generator and analyzer waveform buffers provides many advantages:

- Testing speeds with multitone techniques are 10 to 100 times faster than conventional swept sinewave techniques.
- Multitone testing can provide total distortion and noise measurements, including both harmonic and intermodulation distortion products in one test
- Synchronous multitone testing is the only known technique for measuring noise in the presence of a test signal, providing for the first time meaningful noise measurements on dynamic processors such as compressors, modulation processors, and noise gates
- A multitone signal is much more realistic than a single sinewave, with both spectral and dynamic characteristics (crest factor) similar to music and voice
- A brief (fractional second) inserted burst of multitone signal in a broadcast program or recording can be recognized and captured by an analyzer for regular, unattended testing of broadcast transmission facilities
- Multitone signals provide realistic stimulus to low bit rate encoders and the output can be analyzed according to psychoacoustic models including frequency masking effects

The major advantages of multitone testing depend on synchronous signals and window-less FFT analysis. As discussed in the FFT-Based DSP Program chapter (see page 13-8), windowing functions are required when analyzing non-synchronous signals by FFT. Application of a window function, however, causes energy to appear to spread over 5 to 10 FFT bins above and below the actual signal frequency. A synchronous signal is one with an exact integer number of signal cycles in the FFT analysis transform buffer. With a synchronous signal, each FFT bin represents a perfect rectangular selectivity curve one bin wide with no spillover to adjacent bins. Synchronous signals are created by:

- having a generator waveform buffer size equal to or an integer sub-multiple of the analyzer FFT transform length
- using the Utilities Multitone Creation menu command to create waveform files in which every multitone signal component is forced to have an exact integer number of cycles in the generator buffer length. See the Utilities Multitone Creation description on page 15-26.

## Multitone Signals

---

A typical multitone test signal consists of a number of sinewaves at frequencies distributed across the audio spectrum. It is usually most convenient for all the sinewaves to have the same amplitude, but amplitudes may be set individually to more closely match typical spectral energy distribution of program material, for example. Also convenient is for the sinewave frequencies to be logarithmically spaced across the spectrum, such as at 1/3-octave intervals. However, any arbitrary spacing scheme may be used which does not violate the synchronous condition. The practical result of a synchronous relationship is that all signal frequencies must be an integer multiple of a basic frequency which is the sample rate divided by the generator waveform length. For example, with a 48 kHz sample rate and a System Two Cascade DSP generator buffer length of 8192, the corresponding basic frequency is 5.859375 Hz. It is normally desirable not to locate signals at the exact 2nd or 3rd harmonic of lower frequency signals in order to leave those bins free for measurement of harmonic distortion products.

## Multitone Analysis

---

The multitone signal, after passing through the device under test, is captured into the analyzer and an FFT performed. Rather than sending a complete FFT analysis to the computer for display, additional post-processing is done following the FFT to extract the most relevant audio performance information:

- Frequency response is plotted by the DSP unit sending to the computer only the amplitudes of the FFT bins containing the fundamental sinewave products of the test signal.
- Phase is plotted by the DSP sending to the computer the phase values at the FFT bins containing fundamental sinewave products.
- Total distortion and noise is plotted by the DSP unit integrating the amplitudes of all FFT bins except those which contain fundamental sinewave signals.
- Noise in the presence of signal depends upon the generator buffer length being exactly half the analyzer transform buffer length, creating “empty bins” in the analyzer which will contain noise from the device under test but no generator-related signals.
- For psychoacoustically-based analysis of coders and decoders, DSP post-processing after the FFT can generate a composite frequency masking curve for any multitone signal.
- Crosstalk function requires use of a stereo multitone waveform, with one or more unique frequencies on each channel in addition to any number of tones common to both channels. It determines the frequency of every generator waveform signal which appears in only one channel. Crosstalk then reports to the computer the amplitudes of all FFT right channel bins at unique left channel frequencies, and all left channel bins at unique right channel frequencies.



## Multitone Audio Analyzer

The Multitone Audio Analyzer (FASTTEST) is a specialized and augmented FFT (Fast Fourier Transform) program usable for analog or digital domain input signals. It combines the functions of the FASTTEST, FASTTRIG, and CODEC programs of System One. The Multitone Audio Analyzer provides time (oscilloscope view) or frequency domain (spectrum analyzer) views of the signal, but the time domain views are rarely used. This program cannot be used until an appropriate multitone arbitrary waveform file is selected on the generator panel (analog or digital) which is driving the device under test. With multitone test signals as the generator arbitrary waveform, the Multitone Audio Analyzer performs post-FFT processing to measure frequency response, total distortion and noise, noise in the presence of test signal, crosstalk, and generate psychoacoustic masking curves in addition to providing conventional spectrum analysis and waveform display. Trigger modes include external, digital generator-synchronized and free running. It can also be made to trigger only upon receipt and recognition of the specific multitone signal presently stored in the generator as a reference. Variable trigger delay may be set to allow devices such as audio processors to settle before measurement. The Multitone Audio Analyzer is normally operated in a synchronous mode with the test signal so that no windowing function is required and maximum theoretical FFT selectivity is achieved. Synchronization is achieved even when the test signal frequencies have been shifted up to  $\pm 3\%$  in passage through the device under test, by a frequency error correction technique. The Multitone Audio Analyzer tests low-bit-rate perceptual coders with multitone signals by summing quantization noise and distortion and comparing it to an imbedded psychoacoustic model of the frequency masking effect in humans.

### Input Selection

The Multitone Audio Analyzer can operate with either digital or analog domain input signals. The Input field near the top of the panel provides the following selections: **Digital, HiRes A/D @65536, HiBW A/D @131072, HiBW A/D @262144, HiRes A/D @OSR,** and **HiBW A/D @2xOSR.**

The “**Digital**” selection takes digital domain audio directly from the connector selected in the Input section (Format and connector selection radio buttons) of the Digital I/O Panel.

All the “**A/D**” selections choose the output of analog to digital converters fed from points following the input attenuators and balanced-to-unbalanced conversion circuitry of the two Analog Analyzer input channels. The Analog Analyzer’s autoranging circuitry or a fixed input range selection on the Analog Analyzer panel controls the audio signal level at this point. DC or AC coupling is controlled as discussed above.

The two “**HiRes A/D**” selections use 24-bit high resolution converters with optimum sample rate ranges up to about 100 kHz (bandwidth greater than 40 kHz). The “**HiBW A/D**” selections use 16-bit converters that operate to 262 kHz sample rates (bandwidth of 120 kHz), but with 10-15 dB poorer residual distortion.

The “**65536**, **131072**, and **262144**” selections provide A/D sampling rates at exactly 65,536 Hz, 131,072 Hz, and 262,144 Hz. Corresponding signal bandwidths are approximately 30 kHz, 60 kHz, and 120 kHz. These three sampling rates produce FFT bin widths that are even, integer numbers of Hz in width. For example, with a transform length of 32,768 samples at the 65,536 Hz rate, bin widths will be exactly 2.000 Hz. Note that the 120 kHz maximum bandwidth is an analyzer figure. Multitone test signals in the analog domain can be generated to a maximum frequency of about 60 kHz, and in the digital domain to approximately 50 kHz. The two “OSR” selections refer to the value in the Output “**Rate**” field of the DIO panel (labeled “**Sample Rate-OSR**” on the large version of the DIO panel). These OSR selections are furnished primarily for testing D/A converters in order to provide analog domain spectrum analysis matched to the digital input stimulus. With these selections, signal bandwidth will be approximately 40% of the selected sample rate value.

## Source Selection

The selections available in the Channel 1 (left) and Channel 2 (right) Source fields depend upon the basic Digital/Analog selection in the Input field above.

When **Digital** is selected as Input, the Source field selections for both Channel 1 and Channel 2 are A, B, or None. **A** and **B** refer to the A and B channels of the two-channel digital signal. With normal stereo program material, A carries the left and B carries the right channel signal. The “**None**” selection disables acquisition of signal into the acquisition buffer, thus preserving whatever signal was there previously. This permits acquisition of signals into the Ch 1 and Ch 2 buffers at two different times for comparison of different devices or the same device at different times.

When any of the A/D selections are made at Input, the Source field selections for both channels of the Multitone Audio Analyzer are Anlr-A, Anlr-B, Anlr Reading Ampl, Anlr Reading Ratio, Ch. A Generator, Ch. B Generator, Jitter Signal, and None.

**Anlr A** and **B** are Analog Analyzer circuit points following all input ranging and balanced-to-unbalanced conversion, but prior to any filtering. These are essentially the same circuit points connected to System Two Cascade’s front-panel BNC connectors labeled Analyzer Signal Monitors, Channel A and Channel B. These are the only two sources likely to be used in normal applications of Multitone Audio Analyzer.

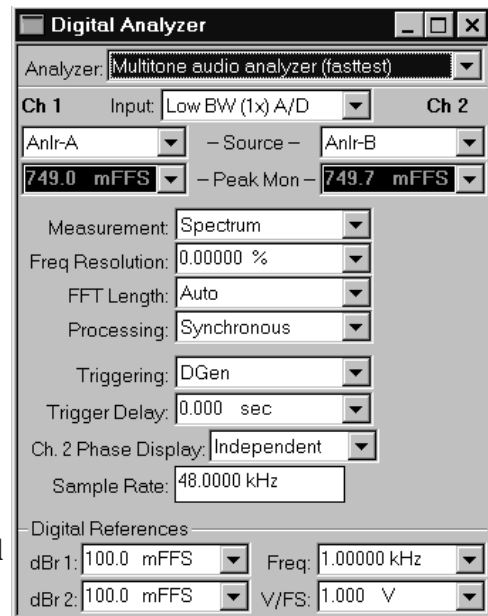

Figure 15-1 Multitone Audio Analyzer (FASTTEST), large version

**Anlr Rdg Ampl** and **Anlr Rdg Ratio** connect to the Analog Analyzer Function Reading meter, the final analog-processed signal before the detectors. This point follows all highpass, lowpass, and option filtering and follows the bandpass/bandreject filter. If the Function Reading meter is in either THD+N mode, the bandreject filter will attenuate the test signal fundamental sinewave to a low level. Up to 60 dB of additional gain is automatically added in the Function Reading meter, following the bandreject filter, under these circumstances. Distortion products and noise signals are thus fed to the A/D converters at levels typically 60 dB higher than normal, resulting in virtually no contribution of distortion from the A/D converters themselves. If the IMD analyzer or W&F analyzer options are present and selected, this point carries the output signal from those option boards. This is essentially the same circuit point connected to the front panel BNC connector labeled Analyzer Signal Monitors, Reading. The Anlr Reading **Ampl** selection furnishes absolute units such as Volts, dBV, and dBu with analog input and dBFS, FFS, and %FS with digital input. The Anlr Reading Ratio selection furnishes the %, dB, and X/Y units. The reference for these relative units is the Analog Analyzer Level meter when the Analog Analyzer Reading meter is set to THD+N, IMD, Ratio, and Crosstalk functions. If the Reading meter is set to W&F function, the reference is an internal calibration factor equal to 100% wow and flutter. Neither of these sources is likely to be used with Multitone Audio Analyzer.

The Ch. A and Ch. B Generator selections connect the A/D input to the Analog Generator Channel A and B monitors, respectively. These are fixed-amplitude replica of the Analog Generator output waveform and are essentially identical to the front-panel BNC connectors labeled Generator Signal Monitors Channel A and Channel B.

The Jitter Signal selection connects the A/D input to the Digital

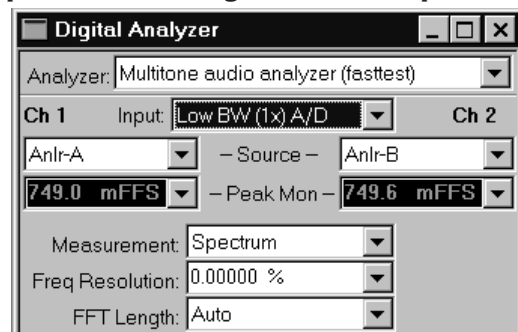

Figure 15-2 Multitone Audio Analyzer (FASTTEST), small version

Input/Output board signal proportional to the jitter of the incoming AES/EBU or Consumer signal. This source is not likely to be used with Multitone Audio Analyzer.

As with Digital Input, the None selection disables acquisition of signal into the FFT acquisition buffer, thus preserving whatever signal was there previously. This permits acquisition of signals into the Ch 1 and Ch 2 buffers at two different times for comparison of different devices or the same device under different conditions.

---

## Peak Level Monitors

---

The Peak Mon reading fields on the Digital Analyzer panel continually display the digital domain peak amplitude at the output of the Ch 1 and Ch 2 A/D converters. Only digital domain units (FFS, dBFS, %FS, or bits) available for these meters. Clicking the down arrow at the end of the display field, then clicking the desired unit will change the selection.

The purpose of these Peak Monitors is to avoid overload of the A/D converters. When Automatic Ranging is in use in the System Two Analog Analyzer, converter overrange should never be a problem. If any of the Analog Analyzer Range controls is fixed, it is the user's responsibility to see that the maximum signal amplitude never exceeds digital full scale.

---

## Measurement

---

The Measurement field controls the type of post-processing done to FFT results before they are sent to the computer for display and possible limits comparison. The six selections are Spectrum, Response, Distortion, Noise, Masking, and Crosstalk. To change the selection, click on the down arrow at the right of the Measurement field, then click on the desired selection.

- **Spectrum:** this selection provides a normal FFT spectrum display with no processing except for "peak picking". The Spectrum selection is typically used without a sweep table (.ADS file), and with a relative large number of Steps at Source 1 of the Sweep

panel to provide good frequency resolution. Typical Steps values are from 250 to 500. If the transform length in use results in more FFT bins in the Start-Stop frequency span being plotted than the number of Steps, peak-picking takes place. With peak-picking, the DSP searches all FFT bins between the previous plotted point and the point presently being plotted and sends the highest bin amplitude in that range as the amplitude of the new point to be sure that no signals are missed.

- **Response:** this selection is always used with a sweep table (.ADS file) which lists the exact frequencies of the sinewaves in the multitone signal which are to be used for frequency response measurements. The DSP sends to the computer to be plotted only the amplitudes of the FFT bins containing those exact frequencies, resulting in a frequency response graph. There are typically from 3 to 30 sinewaves in most multitone signals.

If the value in the Frequency Resolution field is greater than zero, the DSP performs an RSS (root-sum-square) integration of all the bin amplitudes within plus or minus the Frequency Resolution value around each sweep table frequency and sends the integrated sum value to the computer to be plotted. This mode is intended for frequency response measurements on devices such as analog tape recorders that introduce frequency modulation (flutter) to signals. Flutter spreads each tone's energy across a small region of the spectrum. This reduces the amplitude of the fundamental tone, since the total energy in the fundamental and all sidebands remains constant during frequency modulation. The RSS summation of FASTTEST combines this spread energy back into a single value, much as the human hearing system responds to signals with small amounts of FM.

- **Distortion:** this selection excludes the amplitudes of the FFT bins known (from the generator waveform) to contain fundamental signals. All other bin amplitudes are summed (RSS) between each adjacent pair of frequencies defined by the Source 1 settings or the values in an attached sweep table. It is not necessary to use a sweep table (.ADS file) listing the exact fundamental frequencies of the sinewaves in the multitone signal being used.

Distortion and noise can thus be summed across the spans determined by the Sweep panel Start, Stop, Log/Lin, and number of Steps, or the spans can be determined by a sweep table. If it is desired to sum the noise and distortion into critical bands, a sweep table can be used which defines the edges of the human hearing system critical bands. The resulting distortion and noise curve is normally compared to the composite masking curve generated in Masking function (see below).

If the value in the Frequency Resolution field is greater than zero, the DSP also excludes all the bin amplitudes within plus or minus the Frequency Resolution value around each fundamental tone frequency before sending the integrated sum value to the computer to be plotted. This mode is intended for distortion measurements on devices such as analog tape recorders that introduce frequency modulation (flutter) to signals. Flutter spreads each tone's energy across a small region of the spectrum. If these close-in sidebands that fall outside the bin containing the fundamental are not to be considered as distortion, they must be excluded, much as the human hearing system masks low amplitude signals nearby in frequency to a stronger signal.

- Noise: this selection may be used with a sweep table (.ADS file) listing the fundamental frequencies of the multitone signal in use, but need not be. Noise mode depends on the FASTTEST FFT Length being set to the value twice the length of the waveform file that generates the multitone signal; the Auto selection normally accomplishes this automatically. The analyzer frequency resolution is thus twice the resolution of the generated signal. The result is that every alternate analyzer FFT bin falls between bins at which the generated signal could contain fundamentals or bins into which harmonic or intermodulation distortion products could fall (assuming that the device under test does not shift fundamental frequencies or produce frequency modulation). The amplitude of these alternate "empty" bins consists of noise generated in the device under test, largely unaffected by fundamental signals or distortion. If the same sweep table is used in Noise mode that is used for response and

distortion measurements, the resulting graph will be a spectrum analysis of noise in the presence of test signal. If a two-point sweep is made with Start at 20 Hz and Stop at 20 kHz, for example, the plotted value at 20 kHz represents the RSS integration of all “empty bins” across the audio band

- Masking: this selection generates a composite masking curve for the particular multitone signal in use. The shape of the curves is based on a model published by psychoacoustician Brian Moore in the Proceedings of the AES 12th International Conference, June 1993, pp 22-23. The shape of the curves varies with frequency. The center frequency of each section of the composite masking curve is located at the fundamental frequencies present in the waveform file downloaded to the generator buffer. The reference amplitude at each frequency is determined by the measuring the amplitude at each fundamental frequency. The masking curve is normally used by saving it as a limit (.ADL) file, then comparing noise and distortion (Distortion selection) integrated across critical bands to the limit curve.
- For Crosstalk function to work properly, there must be at least one unique frequency in each of the generator channel waveforms in addition to sinewaves common to both channels. Crosstalk function automatically determines from the two generator waveform buffers which frequencies are unique to each channel. Then, Crosstalk measures the amplitude on the opposite (non-driven) channel at each of those unique frequencies.

If Crosstalk is used without a Sweep Table, the resulting graph consists of a series of horizontal plateaus, each centered around the frequency of a crosstalk tone and scaled vertically to the measured crosstalk level of that tone. Results are easier to interpret when a Sweep Table is used. The table consists of a list of the approximate frequency of each pair of unique tones, assuming that the left-only and right-only tones in the test signal are fairly closely-spaced pairs.

Sample crosstalk waveforms have been included in the C:\APWIN\WAVEFORM folder. XTLKLEFT.AGM, XTLKRIGH.AGM



are monophonic waveforms for left and right channel buffers respectively. XLTK.AGS is a stereo waveform with 4 frequencies different on each of the channels.

---

## Frequency Resolution

---

The Frequency Resolution field is a numeric entry field with % units. The user may enter values up to 13% which are used to control triggering and error correction and in Response and Distortion Measurement functions.

For recognition and triggering on short bursts of externally-applied multitone signal, the Frequency Resolution field must be set to a value at least as large as the percentage that frequencies may have been shifted in the device under test. For example, to capture a multitone burst from an analog tape recorder whose speed may differ by as much as 2% from the tape machine which recorded the signal, a value of 2% or greater must be entered into the Frequency Resolution field.

In Response function, the amplitudes of all FFT bins within plus and minus the Frequency Resolution value of each sweep table value are combined in RSS (root-sum-square) fashion and furnished to the computer as the integrated amplitude of the bins within that range. The purpose of this function is to provide accurate frequency response measurements of devices with wow and flutter. Wow and flutter spreads the energy from a single tone across a narrow spectral band.

In Distortion function, the amplitudes of all FFT bins within plus and minus the Frequency Resolution value of each sweep table value are excluded from the RSS computation of energy falling between tones. Distortion function defines all signals other than the fundamental tones as distortion and noise. Entering a non-zero value of Frequency Resolution causes flutter sidebands to not be included in the distortion measurement.

---

## FFT Length

---

The FFT Length field value controls the record length used when signal is acquired or a re-transformation is initiated. Longer transform

lengths produce greater frequency resolution in the resulting FFT, but require longer times to acquire and to transform the signal.

To change the FFT Length, click the down arrow at the end of the field and select the desired value. Available selections are Auto, 512, 1024, 2048, 4096, 8192, 16384, and 32768 samples. The Auto selection automatically sets the acquisition buffer and transform length to be exactly twice the length of the arbitrary waveform presently loaded into the analog or digital generator. This condition is necessary for the Noise function of the Multitone Audio Analyzer to work.

The time required to acquire a waveform of this length may be computed from knowledge of the sample rate.

## Processing

Normal operation of FASTTEST involves acquisition of a multitone signal which was generated from a multitone waveform file by System Two Cascade's generator. The multitone waveform files furnished with APWIN and System Two Cascade are created so as to be synchronous with one or another of the analyzer acquisition buffer lengths available in FASTTEST. Every sinewave in the generated signal goes through an exact integer number of cycles in the generator buffer and in the analyzer transform buffer. No windowing function is then required and maximum theoretical FFT selectivity is achieved with full dynamic range available in bins adjacent to a bin containing a full-scale signal. This mode of operation is selected by the "Synchronous" selection in the Processing field.

A key feature of the Multitone Audio Analyzer is its ability to compare the tone frequencies in an acquired multitone waveform with the digital reference copy of the transmitted or pre-recorded waveform presently in the generator buffers. If this comparison shows that the tone frequencies have been shifted up or down due to the signal originating from a device with a different clock frequency from the analyzer or due to analog tape player speed errors, FASTTEST corrects all the tone frequencies to the reference signal values. This re-creates the original synchronous relationship so that no window function is required before the FFT, and maximum theoretical FFT selectivity is

obtained. The maximum frequency difference that can be corrected is  $\pm 3\%$ . FASTTEST is normally operated with Frequency Error Correction enabled when analyzing signals generated by another Audio Precision instrument or previously recorded and now being reproduced. This mode of operation is selected by the “Freq Corrected” selection in the Processing field.

For real-time testing of a device that does not shift frequencies by driving its input and simultaneously measuring its output, Frequency Error Correction is unnecessary since the input and output signal are made synchronous by System Two Cascade’s architecture. Testing will proceed faster without Frequency Error Correction. This mode of operation is selected by the “Synchronous” selection in the Processing field.

If for some reason it is desired to measure remotely-generated or pre-recorded signals without use of the Frequency Error Correction feature, it will normally be necessary to use a window function to obtain useful results, as described in the FFT-Based DSP Programs chapter. The “Windowed” selection of the Processing field enables the Hann window. The shape of a Hann window is illustrated in Figure 14-3 on page 14-7 in the FFT Spectrum Analyzer chapter.

---

## Triggering

FASTTEST has six triggering modes selectable in the Triggering field—Tight, Normal, Loose, DGen, External, and Off. The first three of these modes are designed for recognition of a multitone signal from a distant generator or a multitone signal previously recorded and then played back. FASTTEST’s multitone signal recognition and triggering capability in these three modes is based on comparison of a short sample of received signal with a digital reference copy of the expected signal, as stored in the generator buffers. To determine whether or not to trigger, FASTTEST performs two types of comparisons:

1. Using the tone frequencies represented in the generator buffer as a reference, FASTTEST looks at the received signal to see if the amplitude at each of a majority of those frequencies is within an acceptable relative amplitude range of the corresponding component

of the reference signal. This criterion allows FASTTEST to ignore simple single-tone test signals, relatively-simple program material such as may be produced by a solo musical instrument, and conditions of silence.

2. Across all sections of the spectrum between tones in the reference signal, FASTTEST looks at the received signal to assure that its amplitude does not exceed a threshold of acceptability. This criterion allows FASTTEST to ignore complex voice and music program material which tends to have energy spread across much of the spectrum.

To permit user control of the triggering criteria, the allowable deviation from reference signal amplitude at generator tone frequencies (1 above) and the amount that energy at all other frequencies must be attenuated (2 above) are settable at three values. The Tight, Normal, and Loose selections each represents a different trade-off between the chance of false response on non-multitone signals versus the possibility of not triggering on legitimate multitone signals from a device with large amounts of noise and distortion and/or large deviations from flat frequency response. Select “Tight” for the minimum chance of false response. This may be necessary when using very short generator waveform files (less than 2048 samples) since the consequent poorer frequency resolution makes it more difficult to discriminate between multitone signals and program material. Use “Loose” if FASTTEST will not otherwise trigger on highly distorted or noisy signals or signals passed through narrow-band or otherwise non-flat devices.

The Off triggering mode produces untriggered or free-running operation. Acquisition and processing begins as soon as the  key or Go button is operated. The Off selection is the recommended triggering mode when System Two Cascade and FASTTEST are testing devices by simultaneously driving their input and measuring their output as opposed to capturing a pre-recorded or remotely-originated multitone signal.

The External triggering selection is operational only with Dual Domain units. It is the signal connected to the EXT TRIGGER IN BNC connector on the rear of the DSP module.

The Digital Generator selection functions only on Dual Domain units. If the Digital Generator is generating a signal from a waveform file, a Digital Generator trigger is issued each time the first sample from the file is generated.

## Trigger Delay

Audio processors (compressors, limiters, etc.) require time to stabilize following any change of level, such as between the multitone burst and the preceding program material. If it is desired to allow processors in an audio chain to stabilize before measurement, a delay can be inserted between recognition and acquisition of the signal. The Trigger Delay field controls the interval between initial recognition of the incoming multitone signal and capture of the portion of signal which will finally be analyzed for response, distortion, noise, etc. Values up to 1.365 seconds may be entered for Trigger Delay. Use of any non-zero Trigger Delay requires that the duration of multitone burst transmitted be increased by the same amount over normal minimum burst length.

### Signal Duration Requirements

The minimum duration of multitone signal which must be present to guarantee analyzer triggering (assuming zero delay in the “Trigger Delay” field) depends primarily upon the generator record length used to create the multitone signal. The required signal duration also varies inversely with the sample rate at which the signal was generated (and, in the case of digital inputs, will be received). Small variations in required duration are also a function of whether the signal is acquired from an analog or the AES/EBU serial digital source, and whether or not the frequency error correction function of the Processing field is in use.

The table below shows the minimum multitone signal duration as a function of generator record length in samples, assuming a 48 kHz sample rate, analog input, and use of the Frequency Error Correction feature. Multiply the values shown by 0.5 at a 96 kHz sample rate, 1.088 with the 44.1 kHz sample rate, and by 1.50 if the 32 kHz sample rate was used. Multiply the values shown by 1.06 if the AES/EBU input is used.

<b>Generator Record Length</b>	<b>Minimum Signal Duration</b>
163384	2.1 sec
8192	1.05 sec
4096	520 ms
2048	260 ms
1024	135 ms
512	70 ms
256	40 ms

If a delay value greater than zero is selected in the “Trigger Delay” field, that value must be directly added to the values computed from the multipliers and table values above. For example, with a 2048-sample generator waveform at 44.1 kHz,  $260 \text{ ms} * 1.088 = 283 \text{ ms}$ . With a 200 ms Trigger Delay, the minimum signal duration for reliable triggering would be 483 ms.

Note that there are performance tradeoffs as the generator record length is reduced. The poorer frequency resolution inherent in shorter record lengths results in reduced ability to measure distortion and noise at the lower audio frequencies while using enough tones in the multitone signal to provide good resolution for frequency response measurements. FASTTEST also becomes more prone to false triggering on program material as resolution is reduced by short record lengths. The 2048-sample generator record length at 44.1 or 48 kHz rates should probably be considered the shortest for good rejection of falsing and excellent distortion and noise measurements across the entire spectrum down to 20 Hz, with 4096-sample records the shortest recommended at 88.2 or 96 kHz rates. The shorter record lengths are useful when testing quiet channels and when testing need not extend down to the lowest audio frequencies.

## Channel 2 Phase Display

The Multitone Analyzer can display phase independently for each channel or inter-channel phase difference. When “Independent” is selected in the “Ch 2 Phase Display” field, either or both Channel 1

and Channel 2 phase may be plotted independently as graph traces. Useful independent phase display requires a real-time, low-delay device under test and the use of generator triggering. When “Interchannel” is selected, the Channel 1 phase parameter remains independent but a plot of Channel 2 phase will show the measured difference in phase on the two channels at each tone frequency. Either mode requires a Sweep Table that lists only the exact frequencies of sinewaves making up the multitone signal.

---

## Sample Rate

When Multitone Analyzer is used with Digital input, it automatically locks to the sample rate of the incoming signal (ISR). When used with the A/D converters, the sample rate is explicit in the Input field (65k, OSR, ISR, etc.). When testing a real-time analog device or D/A converter, the A/D converter sample rate must be set by the user to be identical to the multitone signal generator, resulting in synchronous signals. If testing an analog multitone signal resulting from playback of a recording or reception of a distant signal, the A/D converter sample rate should be selected equal to the known sample rate of the distant or recorded generator. In either case, frequency error correction (Freq Corrected selection in the Processing field) must also be used to achieve an exactly synchronous condition. If the selected A/D converter sample rate differs by more than approximately three percent from the actual rate used when the signal was recorded or transmitted, frequency error correction may not be able to correct the signal.

---

## Digital References

The bottom section of the large version of the Digital Analyzer panel includes four reference values.

The dBr1 and dBr2 values serve as the reference for the dBr1 and dBr 2 units. These units are selectable at the Data 1 through Data 6 areas of the Sweep panel when Fasttest is the Instrument, Digital domain input is selected as the Input, and Fasttest FFT Ch 1 or Ch 2 Ampl is the selected Parameter in the Data browser. The dBr1 and dBr2 references on the FFT panel may be entered in either analog or digital domain.

The V/FS value is the analog-to-digital scaling value. When testing an external Analog to Digital converter (A/D), the value of analog input voltage that produces digital full-scale output may be typed into this field. The Data 1 through Data 6 units may then be selected as V, V<sub>p</sub>, V<sub>pp</sub>, dBu, or dBV to express the measured digital amplitude in terms of the analog input value to the A/D converter under test.

The Frequency value serves as the reference for the relative frequency units (octaves, decades, %Hz, etc) selectable at the Source 1 area when Fasttest is the Instrument and FFT Freq is the selected Parameter in the Source 1 browser.

## Sweep Browser Settings and Readings

When Multitone Audio Analyzer is selected on the Digital Analyzer panel and “Fasttest” is selected in the Instrument column of the Source and Data Browser, the following Parameter selections are available for sweeps:

Readings (for selection at Data 1 through Data 6 to be plotted as traces): Ch. 1 Ampl or Ch. 2 Ampl., Ch. 1 Phase and Ch. 2 Phase.

Reading Units: when Digital input is selected on the DSP analyzer panel, the available readings units on the Sweep panel are FFS, %FS, dBFS, Bits, V, V<sub>p</sub>, V<sub>pp</sub>, dBu, dBV, dBr1, and dBr2. The FFS, %FS, dBFS, and Bits selections are the normal digital domain units. The V, V<sub>p</sub>, V<sub>pp</sub>, dBu, and dBV analog domain units all use the V/FS conversion factor at the bottom of the FASTTEST digital analyzer panel. These analog domain units may be useful when testing A/D converters, by entering the full-scale analog input value for the converter under test. The dBr1 and dBr2 units are with reference to the zero dB reference values in the dBr1 and dBr2 Reference fields at the bottom of the Digital Analyzer panel. Normal usage is with dBr1 serving as the Channel 1 reference and dBr2 serving as Channel 2 reference, but this relationship is not required. The calibration of the dBr1 and dBr2 units refers directly to the dBr1 and dBr2 Reference values entered on the digital analyzer panel when those reference values are entered in digital domain units (FFS, dBFS, etc.). If the values entered into the dBr1 and dBr2 Reference fields are in analog



domain units (V, dBV, dBu, etc.), those analog domain reference values are converted to the digital domain via the V/FS Reference value on the FASTTEST panel before being used as zero dB reference values.

When any A/D selection is made for Input, the available readings units on the Sweep panel are V, dBu, dBVu, dBr A, dBr B, dBg A, dBg B, dBm, and W (Watts). V, dBV, and dBu are absolute units with the standard definitions. The dBr A and dBr B units are with reference to the dBr A and dBr B Reference values on the Analog Analyzer panel. The dBg A and dBg B units refer to the current output amplitude values of channels A and B of the Analog Generator. The dBm and Watts units are with reference to the dBm and Watts Reference impedance value on the Analog Analyzer panel.

Settings for FASTTEST (for selection at Source 1 as the independent, swept variable or Source 2 for nested sweeps) are: FFT Time, FFT Freq., Trig Delay and Resolution. When the FFT Time parameter is selected as the setting, the available units on the Sweep panel are seconds. When FFT Freq is selected as the setting, the available units are Hz plus all the variable frequency units (%Hz, octaves, PPM, etc.). The relative frequency units are all with respect to the value in the Frequency Reference field at the bottom of the digital analyzer panel.

## Phase Display

FASTTEST can measure the phase of sinewave components of either channel of the received multitone signal when testing local, real-time devices. FASTTEST can also measure interchannel phase of two-channel devices with remote or pre-recorded signals. Phase measurements are always made with a sweep table (.ADS file) attached which lists the exact fundamental frequencies of the test signal. The Measurements field selection must be in “Spectrum” function for phase measurements.

Channel 1 and Channel 2 phase measurements may be displayed independently for each channel. Independent phase measurements can be made only on local, real-time devices driven from System Two Cascade’s own generator. They are not possible when measuring

previously recorded and re-played signals, nor from remote-origin signals, due to lack of a phase reference. The appropriate generator triggering selection of FASTTEST must be used when making independent phase measurements.

To display the interchannel phase difference of a stereo device, FASTTEST can also determine the difference between the phase measurements on the two channels at each frequency. This interchannel difference may be plotted instead of actual Channel 2 phase values. When the “Ch. 2 Phase Display:” field is set to Independent, the “Ch. 2 Phase” parameter selection in a Data browser will display the phase measurements of the Channel 2 signal. When Interchannel is selected, the Ch. 2 Phase parameter will plot the phase difference between Channel 1 and Channel 2 at each frequency of the sweep table. In either case, the Ch. 1 Phase parameter plots the phase measurements of the Channel 1 signal.

## Saving and Loading Waveforms

Both channels of acquired waveform remain in the DSP Acquisition buffer until one of the following events:

-  (Go, Sweep Start, etc) is pressed to acquire new waveforms
- a different DSP program (or no DSP program) is loaded, by changing the “Analyzer” field contents on the Digital Analyzer panel
- power is turned off to System Two Cascade
- different waveforms are downloaded from disk as described in this section.

While the waveform is still present in the Acquisition buffer, full flexibility exists to change back and forth between time and frequency domain analysis (FFT Time vs. FFT Frequency at Source 1). Full flexibility exists to view different time portions of the record, to perform FFTs of different transform length (and, with FFT to position the transform starting point at different places in the record). Full ability exists to change window functions, to change FFT post processing

modes, to change time domain processing modes, etc. The results of any and all of these different modes of analysis may be saved one at a time, as test files to disk. Once the waveform is gone from DSP memory, however, no further ability exists to analyze the signal other than re-loading test files to look at the specific analyses which were saved. If full flexibility for continued analysis is desired, the acquired waveform itself may be saved to disk, rather than merely saving test files each of which represents one particular processed result of one type of analysis. The saved waveform can then later be downloaded to the DSP Acquisition buffers for further analysis. Single-channel waveforms saved at different times can later be individually loaded into the two channels of Acquisition buffer for comparison in the time or frequency domains.

## Saving Waveforms

---

Selected sections or the entire contents of the Acquisition buffers may be saved to a disk file by the File Save As menu command, selecting either the “Stereo Waveforms (\*.AAS)” or “Mono Waveform (\*.AAM)” as the Save As file type.

A Stereo Waveform file (.AAS) consists of two waveforms joined together into a single file. A Mono Waveform file (.AAM) contains a single waveform. To simultaneously save the waveforms from both Acquisition buffer channels, select the Stereo choice. To save only one of the channels, select Mono.

When the waveform file type is selected, a file name is typed in by the user, and the Save button is clicked, a dialog box as illustrated in Figure 15-3 will appear. The left half of the dialog box defines what will be saved into the first section of a waveform file and the right half defines what will go into the second section.

### Full Acquisition Buffer vs Transform Sub-Section

The choices in each section are None, Acquired-Ch 1, Acquired-Ch 2, Transform-Ch 1, and Transform-Ch 2. When saving a Mono file, the right half will be gray since it is not applicable. The “Acquired” choices will result in saving the entire contents of an Acquisition buffer to disk. The “Transform” choices result in saving only the sub-section

of the Acquisition buffer specified by the Transform Length selection or the value automatically selected as twice the generator waveform length when Auto is selected. If the Transform Length has not been changed between the time the waveform was acquired and the time it is saved, there will be no difference between the “Acquired” and the “Transform” selections. If the Transform Length value has been reduced following acquisition, the “Transform” selection will be the shorter value presently specified in the transform field while the “Acquired” selection would save the entire length which had been acquired at the original value of Transform Length. When the “Transform” selection is chosen and the currently-selected Transform Length is less than the full buffer (for example, a 1024 sample transform out of a 16,384 sample acquisition buffer), the starting point of the section saved to disk is the first sample in the buffer. If a smaller section of the waveform is sufficient for the intended future analysis purposes, use of the “Transform” selections can result in much smaller disk files than the “Acquired” selections. DSP memory width is 24 bits and computer disk files are organized around 8-bit bytes, so the length of a disk file is approximately three times the length of buffer it was saved from. One channel from a 16,384 sample acquisition buffer will thus result in approximately a 48k file size, while use of the “Transform” selection with a selected Transform length of 1024 samples would result in about a 3k file size.

## One vs Two Waveforms

The selections in the left half of the dialog box determine which buffer contents go into a Mono waveform file or into the first section of a Stereo waveform file. The contents of the second section of Stereo waveform files

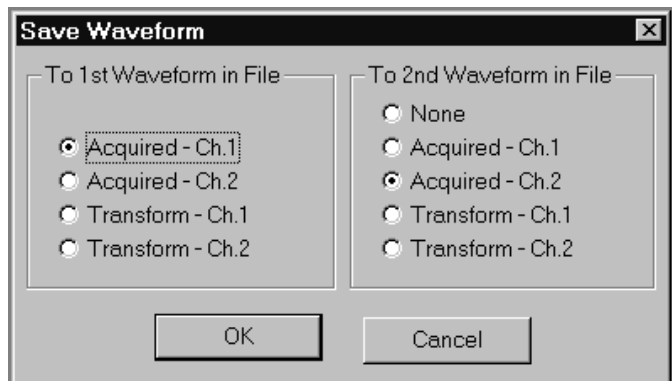

Figure 15-3 Save Waveform Dialog

are defined by the settings of the right half of the dialog box. The right half of the dialog box is not applicable and thus is gray when saving a monaural waveform. It is normally preferable for the two sections of a Stereo waveform file to contain records of the same length, so normally one would not use the “Acquired” selection for one section and the “Transform” selection for the other.

### Combining Mono to Stereo

It is possible to save single channel waveforms acquired at two different times and then combine them into a Stereo waveform so that simultaneous time or frequency domain analysis may be made for some “before and after” conditions. Save a Mono waveform from the first set of conditions, specifying the channel number where the desired data is presently located. Under different test conditions or with a different device under test, save another Mono waveform with a different name. Use the Open Waveform feature described below to load one of these waveform files into the Ch 1 Acquisition buffer and the other into the Ch 2 Acquisition buffer. Then, use the Save As command, select Stereo waveform and supply a new file name, and select the Ch 1 waveform into the first section and Ch 2 into the second.

It is also possible to use the DOS Copy command to concatenate two Mono waveform files into a new Stereo file. The command (from the DOS prompt) is:

```
COPY /B FILENAME1.AAM + FILENAME2.AAM NEWFILE.AAS
```

### Loading Waveforms

Existing waveform files may be downloaded from computer disk to the DSP via the File Open command with its subsidiary selections of Stereo Waveforms (.AAS) or Mono Waveforms (.AAM). Selection of the desired waveform file name (after navigating to the desired directory, if necessary) and clicking the Open button then displays the Open Waveform dialog box as illustrated in Figure 15-4. The left half selections determine which DSP buffer the first section of the waveform file will be loaded into. The right half of the dialog (inapplicable and thus gray if opening a monaural waveform) defines

which buffer the second section of the waveform file loads into. The “Acquired” and “Transform” selections work similarly to the Save Waveform operations described above. Clicking OK then actually downloads the waveform file contents. After the waveform is loaded, the **F6** and **CTRL F6** keys and settings on the Digital Analyzer panel and Sweep panel may be used as described earlier for continued analysis of the waveform.

If the downloaded file length is greater than the length of the specified buffer, an error warning will be displayed. If the downloaded file length is greater than the buffer size, the portion which fits in the buffer can be analyzed normally and the remainder cannot be viewed. Since FFT has the longest buffer, it can completely view files saved from FASTTEST, but FASTTEST will not be able to accept a full waveform file saved from FFT. If the downloaded file length is shorter than the buffer size, erroneous analysis will result if the selected Transform Length extends beyond the last data sample in the buffer. The contents may first be displayed in Time Domain mode to determine exactly where the signal ends.

## Correcting Downloaded Waveforms

If a previously-acquired and stored waveform file is downloaded to System Two Cascade by the File Open Mono Waveform or File Open Stereo Waveform command, frequency error correction may also be manually invoked by selecting the “Freq Corrected” selection of the Processing field and pressing the F6 key after the waveform has been loaded. This

pre-supposes that the acquired waveform initially resulted from stimulus by the multitone waveform presently loaded into the

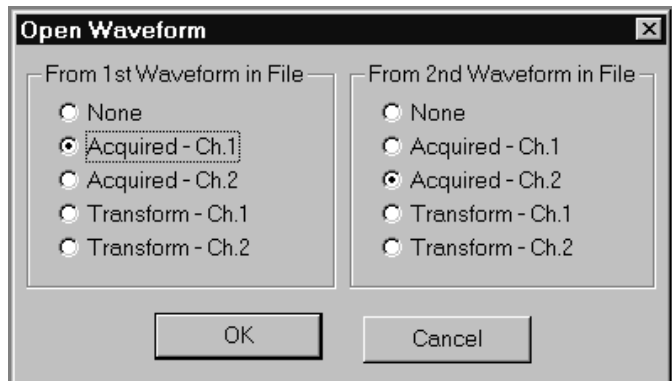

Figure 15-4 Open (Load) Waveform Dialog

generator, since frequency error correction operates by referring to the generator waveform. An application of this feature is when testing the A/D function of computer sound cards. An analog multitone signal from System Two Cascade is fed to the sound card analog inputs and recorded to the computer disk. The resulting sound file is converted from the computer .WAV file format to Audio Precision's .AAM or .AAS format by a software utility available from Audio Precision. Since the computer's clock rate would normally be at a slightly different frequency from System Two Cascade's clock, the frequencies in the waveform file will not be exactly synchronous with a resulting rise in the distortion floor. Applying frequency error correction following the download will make the signal synchronous.

## Creating Multitone Waveform Files

---

Even though many waveform files are furnished in the C:\APWIN\WAVEFORM folder, the user may desire to create his own. The menu command Utilities Multitone Creation leads into a series of dialogs to create files that will generate multitone signals from the System Two Cascade generator. It also creates .ADS sweep tables used by FASTTEST.

The Multitone Creation utility can operate with a standard APWIN data export file (.ADX) as its input, or the multitone frequencies and amplitudes may be specified during operation of the Multitone Creation utility.

This utility provides capabilities previously not available or available only with difficulty (stereo waveforms of matched amplitude, Microsoft .WAV file output in addition to Audio Precision waveform files, automatic creation of sweep tables, simple randomization of phase values). However, the original DOS interface to MAKEWAV3 is still available via the Audio Precision program group.

### Main Menu, Multitone Waveform Creation

---

The dialogs are reached via the Utilities Multitone Creation menu item. When this command is selected, the Main Menu for this utility is displayed, as illustrated in Figure 15-5. A unique waveform name should be typed into the Waveform Name field. The new waveform,

carrying this name, will be stored in the current working directory as established by the File Set Working Directory command. The Sample Rate at which the waveform will be used should be typed into the Sample Rate field. The desired Waveform length should be selected in the Multitone Waveform Length field. Longer waveforms provide higher frequency resolution but require greater time for generation, acquisition, and processing. Frequency resolution (the lowest possible frequency, also the minimum spacing between frequencies) is  $(\text{Sample Rate}) / (\text{Multi-tone Waveform Length})$ . Thus, with a 48000 Hz Sample Rate, a Waveform Length of 8192 samples produces a frequency resolution of about 5.86 Hz and a Waveform Length of 2048 samples produces a resolution of about 23.44 Hz. The Record Length field is normally set to the same value as the Multitone Waveform Length except for some specialized applications. The Margin Headroom field is normally left at the default 1.0 dB value, but may be decreased to nearly zero in order to obtain maximum signal-to-noise ratio for the waveform or may be increased in order to produce digital domain signal amplitudes of a specific absolute value.

The four checkboxes at the lower left of the panel control additional actions beyond basic creation of the multitone waveform

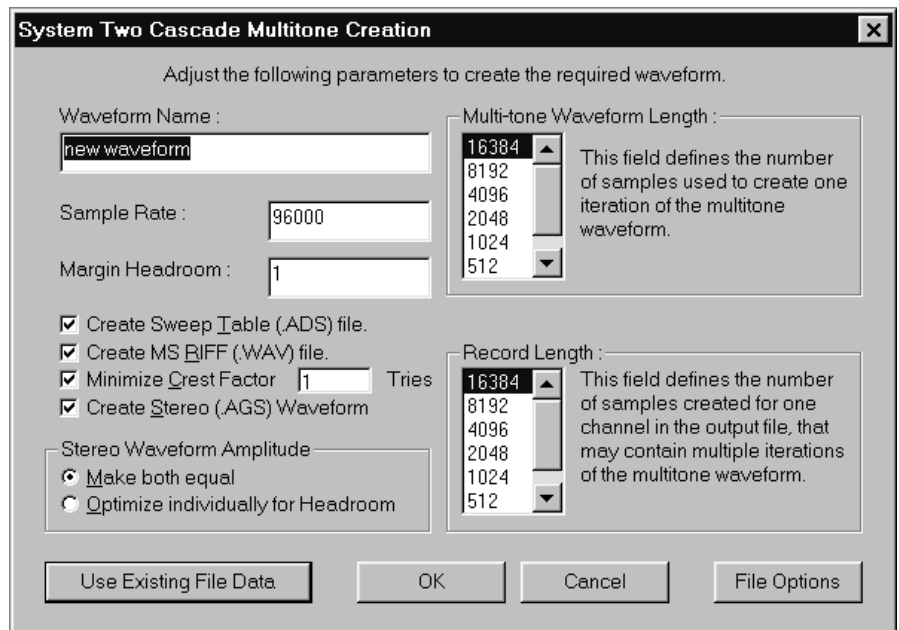

Figure 15-5 Utilities Multitone Creation, Main Menu



file. The Create Sweep Table checkbox causes creation of a sweep table (.ADS file) typically used for response, distortion, and phase measurements. The Create MS RIFF (.WAV) checkbox creates a Microsoft-compatible .WAV file in addition to the Audio Precision format file. This .WAV file can be played by Microsoft's Media Player utility and all sound card software. The Minimize Crest Factor checkbox and numeric entry field labeled "Tries" will cause a phase randomization process to take place for the number of attempts specified, with the results retained that produce the lowest crest factor (peak-to-RMS ratio). The Create Stereo Waveform checkbox causes the process to create a stereo (.AGS) waveform containing independent signals for the left and right channels. When this box is checked, a subsidiary choice appears that gives the choice of making the tone amplitudes of the two channels equal or optimizing each independently for maximum headroom. If the stereo waveform is to be used for stereo balance (differential gain) measurements, the "Make both equal" choice must be selected.

The Multitone Creation utility can also create as many as four different types of data files, controlled by the Supporting File Options dialog (Figure 15-6) that appears when the File Options button is clicked. These file types will be created if the corresponding box on the Supporting File Options dialog is checked. An APWIN data file (.ADA) listing the multitone signal frequencies and amplitudes results from the first checkbox. An ASCII text file (.ADX) listing of that same information results from the second checkbox. A waveform statistics (.WFS) ASCII text file results from the third checkbox. The fourth checkbox controls creation of a sweep table statistics (.STS) ASCII text file. See the Statistics section on page 15-32 for more information on these files.

The decision must be made between use of an existing file

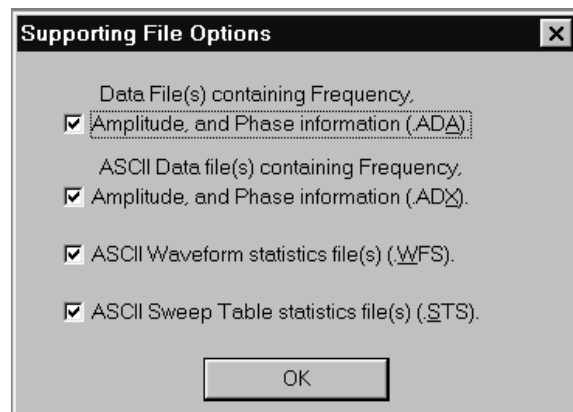

Figure 15-6 Supporting File Options Dialog

containing a set of frequency-vs-amplitude points as the model for the multitone, or creating and editing a new set of frequency-amplitude points. To use an existing file containing this data, click the “Use Existing File Data” button. To create a new set of frequency-amplitude points, click the “OK” button. In either case, the Main Menu will disappear and a message will indicate that the present setup panel conditions are being saved under a standard test name (MAKEWAVE.TMP).

### Frequency List Creation

If “OK” was clicked rather than using existing data, the Frequencies Menu dialog will appear, as illustrated in Figure 15-7. This permits entry of the highest and lowest tone frequencies desired in the Start Frequency and Stop Frequency fields, selection of the total number of tones (including Start and Stop) in the “Number of frequencies” field, and selection of a logarithmic or linear relationship between those frequencies. If some arbitrary set of frequencies is desired rather than either equal log or linear spacing, you will be able to edit to the desired values in a following step. Press the OK button to continue.

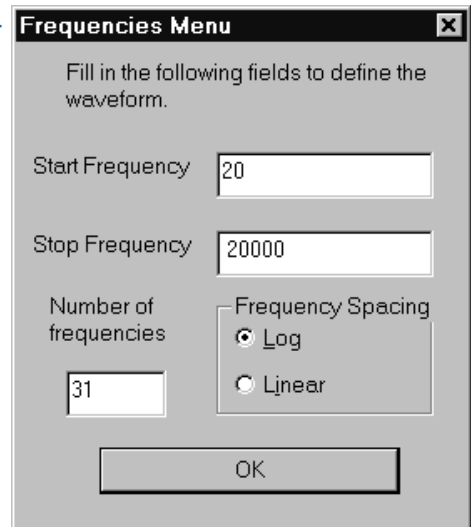

Figure 15-7 Frequencies Menu, Utilities Multitone Creation

### Use of Existing File for Frequency List

If the “Use Existing File Data” button is clicked, a dialog will appear. This dialog prompts you to use the File Open menu command to open an existing test, data, equalization, or sweep table file. You may also Import an ASCII data file containing a list of frequencies and amplitudes that will define the multitone.

## Modification of Data

With either a newly generated frequency list or an existing file loaded, the Data Editor will appear after a few moments of processing. Three columns may be occupied—frequency, amplitude, and (if present in the loaded file) phase. The values in the frequency column (Gen Freq) will be the nearest synchronous frequencies to those specified by loading an existing file or by your entries in the Start, Stop, Log/Lin, and Number of Frequencies fields if you used the Frequencies Menu dialog. A synchronous frequency is one that will contain an exact integer number of complete cycles in a buffer of the selected Multitone Waveform Length at the selected Sample Rate. The Edit Waveform Definition dialog illustrated in Figure 15-8 will appear on top of the Data Editor. If you are not satisfied with the frequency values and/or magnitude values, click the “Edit Data Values” button. A message will appear indicating that you can then click in any Data Editor cell and change to the desired values. After editing, click on “Continue Procedure” to return to the Edit Waveform Definition dialog. Note that any frequency values that you changed will be automatically changed to the nearest synchronous frequency (if required) at this point. To produce a multitone waveform with exactly equal amplitudes at each frequency, click on the “Set all Magnitude values to 0.0 dBV” button. All phase values may be set to random values by the “Randomize Phase values” button, or all set to zero

(every tone’s waveform starting from zero signal level at the beginning of the record) by the “Set Phase values to 0.0 deg” button. Note that the individual waveforms that make up a Stereo waveform must not be individually randomized if they are to be used for

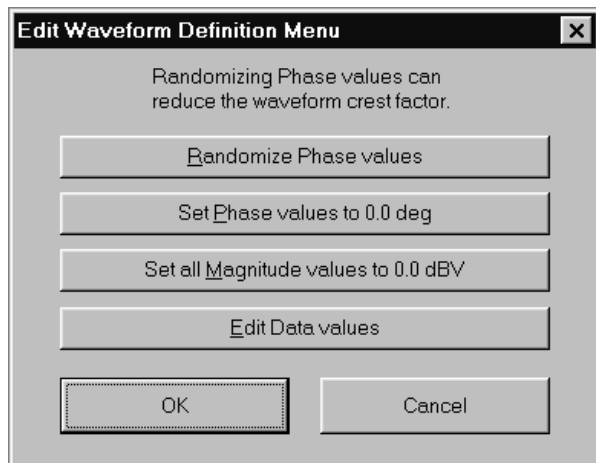

Figure 15-8 Edit Waveform Definition Menu, Utilities Multitone Creation

the measurement of interchannel phase. When you are satisfied with the multitone definition shown in the Data Editor, click on the OK button. The specified waveform will be generated by the DOS program makewav3.EXE and saved under the name you specified at the beginning. The test setup you had at the beginning of the process (saved as MAKEWAVE.TMP) will be re-loaded. You will be prompted as to whether you wish the new waveform to be loaded into the arbitrary waveform generator memory.

### Sweep Table Definition

If the Create Sweep Table checkbox on the Main Menu was checked, a Sweep Table Definition dialog will appear as illustrated in Figure 15-9. Check Fundamental Frequencies to create a table to be used for frequency response, phase, or total distortion measurements.

Check Harmonics and enter the range of harmonic orders to obtain a table to be used for measurement of harmonic distortion only. Check IM products and enter the desired upper limit of IMD product order to obtain a table for measurement of intermodulation distortion products only. After creation of a sweep table, the user will be asked whether it should be automatically loaded.

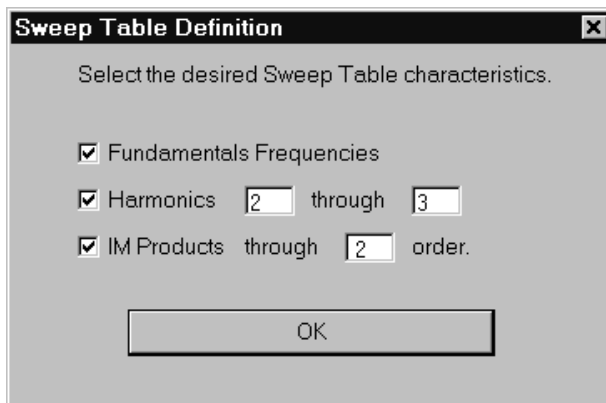

Figure 15-9 Sweep Table Definition Dialog, Multitone Creation Utility

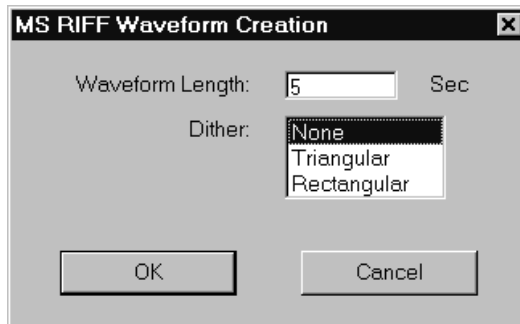

Figure 15-10 Microsoft .WAV File Creation

## Microsoft WAV File Creation

---

If the Create MS RIFF (.WAV) file box was checked on the main menu, the MS RIFF Waveform Creation dialog will appear as illustrated in Figure 15-10. Here you may specify the duration of the .WAV file and whether dither will be added (and the type of dither) during generation of the file. Dither, if added, is based on 16-bit resolution.

## Statistics

---

When MAKEWAV3.EXE operates, it may generate detailed reports if the appropriate boxes were checked in the Supporting File Options dialog accessible from the Main Menu of the Multitone Creations utility. The waveform statistics report (.WFS file) includes exact frequencies of each tone, number of complete cycles of each frequency in the file, and relative amplitude of each tone. It also lists peak and rms amplitudes of the composite signal and the computed crest factor, and the absolute digital domain amplitude corresponding to 1 Volt or 0 dB input file specification. Similarly, a summary report of the contents of a sweep table is generated if the sweep table option (.STS file) is chosen. Dialogs will appear asking you whether you wish to view Waveform Statistics and (if relevant) Sweep Table Statistics. If a stereo waveform file is generated, two .WFS reports are generated, with the final character of the channel A filename replaced with "A" and the channel B filename with "B". These .WFS and .STS reports are automatically loaded into the Microsoft Notepad text editor and minimized. Click on the desired button on the Win95 Taskbar across the bottom of the screen to view (and print, if desired) the statistical reports.

## Waveform Files, Stereo Separation

---

Stereo waveform files can support stereo separation testing in addition to response, noise, distortion, and phase. Such a waveform normally has identical tone frequencies and amplitudes on both channels across the audio band, plus a few unique ones inserted on each channel. Check the Create Stereo Waveform box and select the Make Both Equal button that appears. Use the Frequencies Menu dialog to define the tones that will be common to both channels. Click

the Edit Data Values button and insert unique frequencies as desired for the A (left) waveform. Complete the required responses for the A waveform. When the utility asks for definition of the B channel waveform, do not change any settings of the Frequencies Menu. Then, click the Edit Data Values button and insert unique frequencies for the B (right) waveform. If the Create Sweep Table option was used, the resulting sweep table(s) will include the unique crosstalk frequencies. These are not desired for response, phase, distortion, or noise testing and should be edited out. Typically, another sweep table is created just for crosstalk testing. This crosstalk sweep table consists of a list of frequencies near each pair of unique tones added for crosstalk testing.

## Waveforms for FASTTEST

If “Auto” is selected as FFT Length in FASTTEST, the acquisition buffer will be automatically set at twice the waveform length presently loaded as the “Arbitrary Wfm” in the generator. Users can manually choose analysis record lengths from 32768 to 512. For Noise mode of FASTTEST to work, the analysis record must be twice the waveform length (as is selected by Auto). If Noise mode is not used, the analysis record may be equal to the waveform length. Thus, for example, an analysis record length selection of 2048 requires a waveform length of 2048 if Noise mode is not used and 1024 if Noise is to be measured.

Longer generator waveforms provide better generator frequency resolution. For example, with 8192 samples and the 48 kHz sample rate or 16384 samples and the 96 kHz sample rate, all signals must be multiples of the 5.859 Hz basic frequency. With 2048 samples and the 48 kHz sample rate, the basic frequency becomes 23.436 Hz. At 512 samples at 48 kHz, the basic frequency is 93.75 Hz. Lower resolution means signals cannot be spaced as close together. This limits the ability to gain detailed information about low-frequency response of the system. Lower resolution becomes even more restrictive when additional criteria are established. For example, it may be desired that signals are not generated in the analyzer bins where AC mains hum signals fall (fundamental, second and third harmonics of AC mains frequency) so that FASTTEST measurements will be sensitive to hum. If harmonic distortion produced by low frequency sinewaves is to be measured, the bins at lower order harmonics of all generated

sinewaves must be kept free from signals. The reduced resolution of shorter generator records is less likely to be a limitation at high frequencies where it represents a smaller and smaller percentage deviation from the desired frequency.

The advantage of shorter record lengths is the shorter required acquisition time and FFT computation time during measurements. A 16384-sample record takes 341.3 milliseconds to acquire at 48 kHz sample rate. A 2048-point analysis record length requires only 42.67 milliseconds to acquire. Computation time of the FFT after acquisition reduces even faster with shorter analysis record lengths. For applications such as a quick check, using only a few tones across the audio spectrum, a shorter sample length and consequently faster acquisition and FFT computation may be appropriate. Required signal burst length with FASTTEST depends on the generator record length as shown in the table below. At 96 kHz sample rate, the minimum burst length will be half the value shown and the lowest frequency and minimum spacing value will be double that shown.

### Generator Record Length vs Attributes (48 kHz sample rate)

Generator Record Length	Minimum Burst Length	Lowest Freq. & Minimum Freq. Spacing
16384	2.1 sec	2.92 Hz
8192	1.050 sec	5.86 Hz
4096	520 ms	11.7 Hz
2048	260 ms	23.4 Hz
1024	135 ms	46.9 Hz
512	70 ms	93.7 Hz
256	40 ms	187.5 Hz

## Quasi-Anechoic Acoustical Tester (MLS)

To load the Quasi-Anechoic Acoustical Tester program (MLS), display the Digital Analyzer panel. Click on the down arrow at the right end of the “Analyzer” field, at the top of the panel. In the list that appears, select “Quasi-anechoic acoustical tester (mls)”. This chapter will use the terms “MLS” and “Quasi-Anechoic Acoustical Tester” interchangeably.

### MLS Overview

Both analog and digital generators offer waveform selections called MLS (Maximum Length Sequence). For typical loudspeaker measurement applications, the MLS (D/A) waveform is selected on the Analog Generator panel, causing the DSP-generated signal to be converted to the analog domain in the D/A converters and fed through the analog generator output stages. The generator output typically drives a power amplifier that drives the loudspeaker under test. A measurement microphone is used to pick up the acoustical signal and return it to the System Two Cascade analog input. System Two Cascade performs balanced-to-unbalanced conversion, automatic gain ranging, and drives the DSP’s A/D converters. The DSP module and MLS software then perform a cross-correlation between the received and transmitted signals to obtain the impulse response that is stored into DSP memory. The impulse response (time domain view) may be displayed on the computer, permitting the user to select the portion of impulse response of interest. This portion may be transformed into the frequency domain to study both magnitude and phase response versus frequency.

These properties are of use when measuring loudspeakers or other electroacoustic devices. The time-selective capability permits separating the device-under-test response from that of the room in which the measurements are made. Alternately the room itself may be measured, studying the reflection characteristics of each surface in the room or of the room taken as a whole. One section of the signal, such





as the direct sound from a loudspeaker, may be separated from another section, such as a room reflection. The time window may be adjusted to allow measurement of any arrival in a complex reverberation pattern. These signals may be examined in the time domain (showing “energy” as a function of time) or in the frequency domain (amplitude and phase vs. frequency).

Electronic effects devices such as digital delays and reverberation units may be measured for both frequency and time domain characteristics. The noise rejection properties of MLS analysis may be valuable when dealing with noisy electronic devices such as communications lines or two-way radio equipment. The analysis technique depends on repeatable time domain behavior in the device under test and is therefore not suited to measuring tape recorders, pitch shifters, time compressors or other devices with wow and flutter or speed error.

### **Waveform Display vs. Frequency Response**

---

Use of MLS typically involves both time domain and frequency domain displays except in repetitive testing with unchanged dimensions between loudspeaker, measurement microphone, and reflecting surfaces. It is normally necessary to examine the time domain impulse response from MLS to determine the exact arrival time of the signal and the first reflection, designation of that time section for FFT spectrum analysis, and finally graphing of the anechoic frequency (and possibly phase) response for examination or comparison to limits. Waveform display and frequency response tests may be loaded without destroying the waveform data in DSP memory if both tests use the Quasi-Anechoic Acoustical Tester analysis function (MLS). You may acquire a signal () with any one of these tests and then easily switch analysis domains by simply loading another of these tests and pressing . This is generally easier than making the necessary Sweep panel changes to change between time and frequency domain displays.



### **Analog/Digital Signal Acquisition and Analysis**

---

Digital signals may be acquired directly from the digital domain via any of System Two Cascade Dual Domain’s digital inputs, or analog

signals may be acquired via System Two Cascade's built-in A/D converters. Signal bandwidth extends beyond 40 kHz at the 96 kHz sample rate, beyond 20 kHz at the 48 kHz sample rate, and proportionately less at the 44.1 kHz and 32 kHz sample rates. Sample rate is selected in the Input field described below.

## Setting Time Spans

The section of the impulse response (time domain) which is to be transformed into the frequency domain is selected by the Start and Stop time values at Source 1 on the Sweep panel when the  key is last used for a time domain display before changing Source 1 to MLS Frequency. Before selecting a frequency domain display it is essential that a time domain display be selected and plotted. To limit FFT analysis to only the direct sound, for example, the Source 1 Start and Stop values must set to the beginning and end of the direct sound arrival. The  key must then be pressed to send this time span information to the DSP. For a series of frequency response measurements under fixed physical relationships between loudspeaker under test and measurement microphone (typical of production test), data for each new speaker can be acquired and transformed in one operation with Source 1 set to MLS Frequency. The time span used in each acquisition and transform will be the time span which had been set at Source 1 the last time that  was pressed.

If the characteristics of the impulse response are not known in advance, the Source 1 Start and Stop values can initially be set to a wide span which includes the whole impulse response. For typical loudspeaker testing applications this might be 0 and 50 ms respectively. The direct sound and the first reflections can be identified, with the beginning of build-up of the first peak in the response determining Start time. By studying the decay of the impulse, the onset of the first reflection can be determined. The Stop value should be set to just before the beginning of the reflected signal. The graph can be zoomed to those points and the time values copied to the Sweep panel (Copy to Sweep Panel command of the right mouse button graph menu) to display only the portion of interest before pressing .

## Time Span vs. Lowest Usable Frequency

---

The setting of Source 1 Start and Stop values limits all subsequent frequency domain analysis to the portion of the time record bounded by these values. An impulse response will oscillate or be active for a length of time roughly proportional to the period of its lowest frequency component. The time record must be long enough to include this oscillation to obtain meaningful information about the lowest frequency component. For accurate measurements this oscillation must be allowed to die down for several cycles, requiring a time record approximately three times the period of the lowest frequency of interest. For example, the period of a 200 Hz signal is 5 ms, implying a 15 ms required time span for three cycles. For loudspeaker measurements this also implies that the first reflection dare not arrive until 15 ms after the direct signal if the measurement is to be anechoic. This requires that the path from loudspeaker to nearest reflecting surface to microphone be at least 5 meters (16 feet) longer than the direct path from loudspeaker to microphone, which requires an unusually large space for testing.

## Resolution vs. Time Span

---

The frequency resolution of any FFT spectrum analysis depends upon the record length (number of samples) upon which the FFT was performed. There will be half as many FFT bins as there are amplitude samples in the record transformed. With MLS, actual resolution is further limited by the fact that for quasi-anechoic analysis, only a short time span of the acquired signal (before the first reflection arrives) is normally selected for analysis by the Start and Stop times on the Sweep panel while the impulse response is viewed in time domain mode. The remainder of the transform buffer is padded out with zeros. Actual resolution is determined by the number of *non-zero* samples. That actual resolution is then effectively interpolated, with the interpolation resolution (apparent resolution) being 2.93 Hz . Typical selected time spans for anechoic measurements in real rooms are on the order of three to six milliseconds. At the 48 kHz sample rate, these time spans may thus include on the order of 150 to 300 data samples and produce actual resolutions on the order of 320 Hz.

## Analyzer Panel Fields

### Input Selection

The Quasi-Anechoic Acoustical Analyzer can operate with either digital or analog domain input signals. The Input field near the top of the panel provides the following selections: **Digital**, **HiRes A/D @ 65536**, **HiBW A/D @ 131072**, **HiBW A/D @ 262144**, **HiRes A/D @ OSR**, and **HiBW A/D @2xOSR**.

The “**Digital**” selection takes digital domain audio directly from the connector selected in the Input section (Format and connector selection radio buttons) of the Digital I/O Panel.

All the “**A/D**” selections choose the output of analog to digital converters fed from points following the input attenuators and balanced-to-unbalanced conversion circuitry of the two Analog Analyzer input channels. The Analog Analyzer’s autoranging circuitry or a fixed input range selection on the Analog Analyzer panel controls the audio signal level at this point. DC or AC coupling is controlled as discussed above.

The two “**HiRes A/D**” selections use 24-bit high resolution converters with optimum sample rate ranges up to about 100 kHz (bandwidth greater than 40 kHz). The “**HiBW A/D**” selections use 16-bit

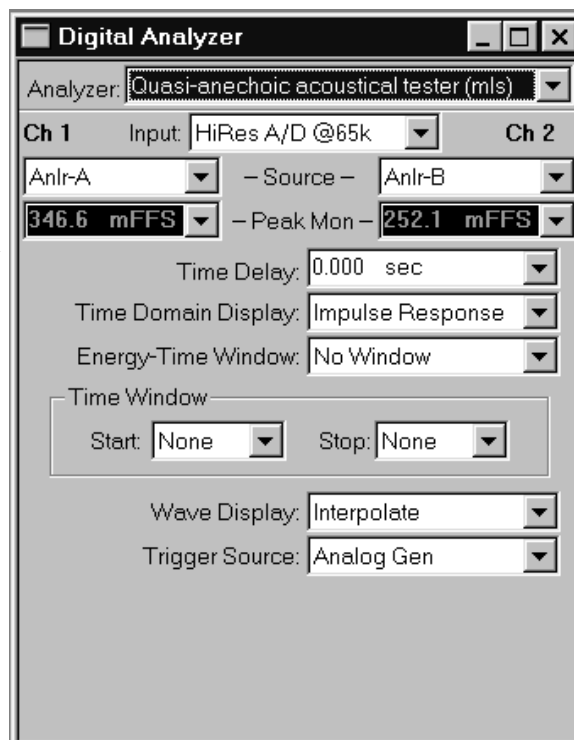

Figure 16-1 MLS Panel, large form

converters that operate to 262 kHz sample rates (bandwidth of 120 kHz), but with 10-15 dB poorer residual distortion. However, distortion performance of both converters is more than sufficient for MLS.

The “**655336**,  
**131072**, and  
**262144**” selections

provide A/D sampling rates at exactly 65,536 Hz, 131,072 Hz, and 262,144 Hz. Corresponding signal bandwidths are approximately 30 kHz, 60 kHz, and 120 kHz. The two “OSR” selections refer to the value in the Output “**Rate**” field of the DIO panel (labeled “**Sample Rate-OSR**” on the large version of the DIO panel). These OSR selections are furnished primarily for testing D/A converters in order to provide analog domain spectrum analysis matched to the digital input stimulus. With these selections, signal bandwidth will be approximately 40% of the selected sample rate value.

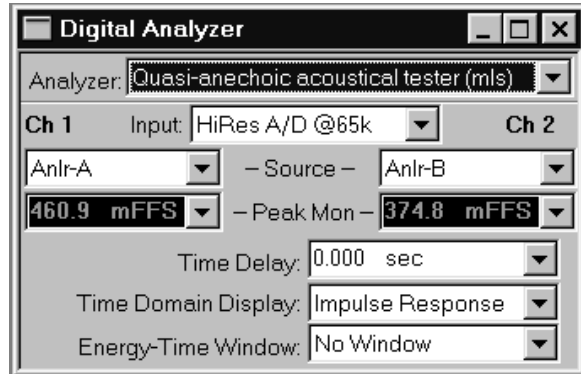

Figure 16-2 MLS Panel, small form

## Source Selection

The selections available in the Channel 1 (left) and Channel 2 (right) Source fields depend upon the basic Digital/Analog selection in the Input field above.

When **Digital** is selected as Input, the Source field selections for both Channel 1 and Channel 2 are A, B, or None. **A** and **B** refer to the A and B channels of the two-channel digital signal. With normal stereo program material, A carries the left and B carries the right channel signal. The “**None**” selection disables acquisition of signal into the acquisition buffer, thus preserving whatever signal was there previously. This permits acquisition of signals into the Ch 1 and Ch 2 buffers at two different times for comparison of different devices or the same device at different times.

When any of the A/D selections are made at Input, the Source field selections for both channels of the FFT analyzer are Anlr-A, Anlr-B, Anlr Reading Ampl, Anlr Reading Ratio, Ch. A Generator, Ch. B Generator, Jitter Signal, and None.

**Anlr A** and **B** are Analog Analyzer circuit points following all input ranging and balanced-to-unbalanced conversion, but prior to any filtering. These are essentially the same circuit points connected to System Two Cascade's front-panel BNC connectors labeled Analyzer Signal Monitors, Channel A and Channel B. These are the only selections likely to be used with the MLS analyzer.

**Anlr Rdg Ampl** and **Anlr Rdg Ratio** connect to the Analog Analyzer Function Reading meter, the final analog-processed signal before the detectors. This point follows all highpass, lowpass, and option filtering and follows the bandpass/bandreject filter. If the Function Reading meter is in either THD+N mode, the bandreject filter will attenuate the test signal fundamental sinewave to a low level. Up to 60 dB of additional gain is automatically added in the Function Reading meter, following the bandreject filter, under these circumstances. Distortion products and noise signals are thus fed to the A/D converters at levels typically 60 dB higher than normal, resulting in virtually no contribution of distortion from the A/D converters themselves. If the IMD analyzer or W&F analyzer options are present and selected, this point carries the output signal from those option boards. This is essentially the same circuit point connected to the front panel BNC connector labeled Analyzer Signal Monitors, Reading. The Anlr Reading Ampl selection furnishes absolute units such as Volts, dBV, and dBu with analog input and dBFS, FFS, and %FS with digital input. The Anlr Reading Ratio selection furnishes the %, dB, and X/Y units. The reference for these relative units is the Analog Analyzer Level meter when the Analog Analyzer Reading meter is set to THD+N, IMD, Ratio, and Crosstalk functions. If the Reading meter is set to W&F function, the reference is an internal calibration factor equal to 100% wow and flutter. These Source selections are unlikely to be used with the MLS analyzer.

The Ch. A and Ch. B Generator selections connect the A/D input to the Analog Generator Channel A and B monitors, respectively. These are fixed-amplitude replica of the Analog Generator output

waveform and are essentially identical to the front-panel BNC connectors labeled Generator Signal Monitors Channel A and Channel B.

The Jitter Signal selection connects the A/D input to the Digital Input/Output board signal proportional to the jitter of the incoming AES/EBU or Consumer signal. This permits spectrum analysis of the jitter. This source is not likely to be used with the MLS analyzer.

As with Digital Input, the None selection disables acquisition of signal into the FFT acquisition buffer, thus preserving whatever signal was there previously. This permits acquisition of signals into the Ch 1 and Ch 2 buffers at two different times for comparison of different devices or the same device under different conditions.

## Peak Level Monitors

---

The Peak Mon reading fields (green digits on a black background) on the Digital Analyzer panel continually display the digital domain peak amplitude at the output of the Ch 1 and Ch 2 A/D converters. Only digital domain units (FFS, dBFS, %FS, or bits) available for these meters. Units may be changed by clicking the down arrow at the end of the display field, then clicking the desired unit.

The purpose of these Peak Monitors is to avoid overload of the A/D converters. When Automatic Ranging is in use in the System Two Analog Analyzer, converter overrange should never be a problem. If any of the Analog Analyzer Range controls is fixed, it is the user's responsibility to see that the maximum signal amplitude never exceeds digital full scale.

## Time Delay

---

The Time Delay field is used to tell the DSP the distance between the speaker under test and the measurement microphone as a reference for the phase measurements. This information allows the DSP to subtract out the transit time delay (propagation time) from the phase readings. As the Time Delay value is adjusted the phase response will slope up or down reflecting the constant time delay component of the data. The initial value of Time Delay may be estimated from a measurement of the distance between loudspeaker

and microphone. See Figure 16-3 for an impulse response plot of a loudspeaker test. Cursor 2 is positioned at the peak of the impulse response and indicates a required delay value of approximately 6.6 milliseconds. The proper final Time Delay value may be determined experimentally as the peak amplitude on a time domain graph or to obtain the smallest slope on phase. The Time Delay field is a numeric entry field that accepts input from the keyboard or by pasting from the Windows clipboard.

### Time Domain Display—Impulse Response vs. Energy-Time

The Time Domain Display field selects between Impulse Response and Energy-Time curve displays. To change display modes, click on the down arrow at the right of the field and click on either Impulse Response or Energy-Time. The Impulse Response selection will show the results of the MLS correlation that is the actual impulse response of the device under test.

The Energy-Time selection will display what is commonly called an “energy-time curve”. The energy-time curve computation process involves transforming the impulse response to the frequency domain, doing further processing in the frequency domain, and transforming

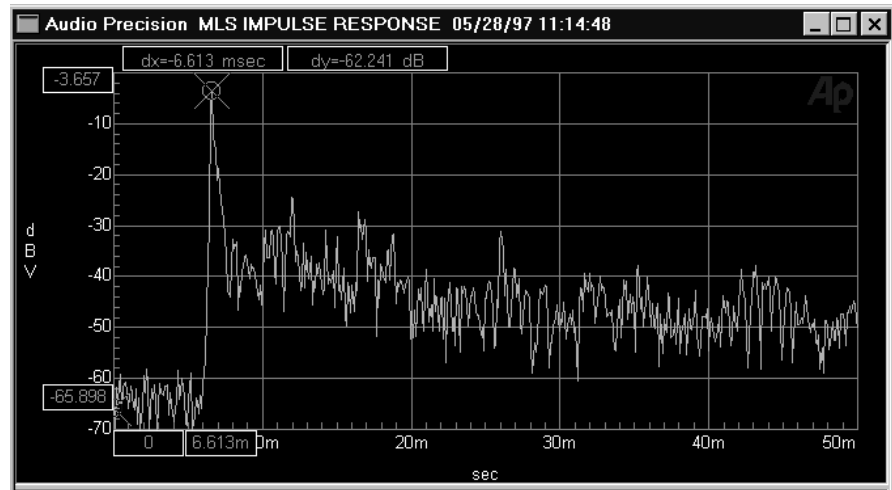

Figure 16-3 Loudspeaker Impulse Response, Showing 6.6 Millisecond Delay to Impulse Peak. This Waveform Furnished as C:\APWIN\S1\PROCEDURE\DEMO\THREEWAY.AAM



the result back to the time domain. A frequency window may be used for the conversion from frequency domain back to time domain. The frequency window is selected in the “Energy-Time Window” field. Click on the down arrow at the right of the field to display the list of selections. The choices are No window, half Hann, Hann, <240 Hz >8kHz, and <120 Hz >16kHz.

The No Window selection will perform the required transformations with all frequency components of the signal included in the computations.

The Hann selection reduces both high and low frequency energy, concentrating on arrivals at the center of the frequency range. Since the processing occurs on a linear frequency scale, this will focus analysis on signals around one quarter of the sample rate. At 48 kHz this will result in the 12 kHz energy dominating the energy-time display. This selection is not fundamentally useful for most applications, but is included for correlation to measurements by other manufacturer’s equipment where this window is used.

The Half Hann selection reduces the contribution of high frequencies. The low frequency information remains unchanged. When operating at the 48 kHz sample rate this window filters out energy above 12 kHz.

The <240 Hz >8 kHz window filters out energy below 240 Hz and above 8 kHz, producing equal sensitivity to signals over a 5 octave range.

The <120 Hz >16 kHz window spreads the analysis over a 7 octave range.

## **Energy-Time Window**

---

The Energy-Time selection causes the DSP to transform the impulse response into the frequency domain, apply a frequency-domain window and Hilbert Transform to the complex frequency response, and then inverse transform the data back to the time domain to produce a plot of the estimated arrival of energy versus time. This “energy-time curve” is an approximation to the actual energy arriving at the microphone, since this energy can never be

known without the simultaneous measurement of both velocity and pressure of the sound. The term “energy-time response” is actually a misnomer since a true computation of energy requires knowledge of both kinetic and potential energy and a microphone signal can only supply one of these. A more accurate term sometimes used in technical papers is the analytic signal magnitude. However, the term energy-time has become common usage and, to avoid confusion, will be used here. Energy-Time curves may also be considered as similar to the envelope of the impulse response. The resulting trace will not show the negative excursions of the impulse response. This display is useful for determining arrival times and relative energy distribution in time.

Since the energy-time graph is computed with transforms, a frequency window must be applied to the data to prevent alias behavior. The frequency window to be used is selected in the “Energy-Time curve” field. The choices are No window, half Hann, Hann, <240 Hz >8kHz, and <120 Hz >16kHz. These windows operate in the frequency domain. The No window selection will perform the required transformations with all frequency components of the signal included in the computations. The deviations from a flat frequency response create ripples in the time domain energy response. The Hann selection is the one window found on software from other manufacturers. This reduces both high and low frequency energy, concentrating on arrivals at the center of the frequency range. Since the processing occurs on a linear frequency scale, this will focus analysis on signals around one quarter of the sample rate. At 48 kHz this will result in the 12 kHz energy dominating the energy-time display. This produces very attractive displays that are very wrong.

The half Hann selection is a window suggested by Lipshitz and Vanderkooy that only reduces the contribution of high frequencies. The low frequency information remains unchanged. When operating at the 48 kHz sample rate this window filters out energy above 12 kHz. Audio Precision developed the remaining two windows for even more accurate measurements of typical audio signals. The <240 Hz >8kHz window filters energy below 240 Hz and above 8 kHz, producing equal sensitivity to signals over a 5 octave range. The <120 Hz >16kHz window spreads the analysis over a 7 octave range. Both

windows produce much more accurate results than the Hann window with only minor increases in alias behavior.

For an excellent technical discussion of the effect of windows on energy-time-curve computation see Lipshitz and Vanderkooy, “Uses and Abuses of the Energy-Time Curve”, Journal of the AES, Vol. 38, No. 11, November 1990, pp. 819-836.

## Time Windows

---

When a section of the impulse response (direct arrival signal before reflections, for example) is isolated and transformed into the frequency domain, the impulse amplitude at the beginning and ending of that section will generally not be exactly the same and thus will not “splice” smoothly. The sharp edges introduced into the impulse response by splicing unequal amplitudes will produce ripples in the resulting frequency response plot. Windowing the time domain data by attenuating the amplitude at the beginning and end of the section to be transformed will reduce this rippling, but also reduces the steepness of transitions in the frequency response plots. The “Time Start Window” and “Time Stop Window” fields select the window applied to the impulse response (time domain) when transforming it to the frequency domain.

The time window is made up of two “half-windows”. The first half is selected in the “Time Start Window” field and is used to process the first portion of data, beginning at the Source 1 Start time on the Sweep panel. The second “half-window” is selected in the “Time Stop Window” field and processes the later portion of data, ending at the selected Stop time on the Sweep panel. Separate selection of the Source 1 Start and Stop “half-windows” permits creation of asymmetrical windows, which provide the optimum match to the asymmetrical shape of the typical impulse response. To change selections, click on the down arrow at the right of the field and click on the desired selection in the list which is displayed. The available selections at both the Time Start Window and Time Stop Window fields are a family of half-cycle raised cosine functions labeled NONE, 5%, 10%, 20%, and 30%. The numeric value refers to the amount of the data record (time span multiplied by sample period) taken up by the window’s transition from zero to full amplitude. The Time Start

Window “half-window” starts with an amplitude of zero at the Sweep panel Start time and climbs to an amplitude of 1.00 (no attenuation) at or before the selected percentage of the record. The Time Stop Window “half-window” starts with an amplitude of 1.00 at or following a point during the record which is within the selected percentage of the record end, and falls to zero at the Sweep panel Stop time. The windows with a steeper transition will alter the data less but will also have less impact on the frequency response ripples. The more gradual transitions have greater ripple reduction but alter the data more. See the Advanced Theory topic for more details and illustrations of the available choices.

## Wave Display

The “Wave Display” field permits selection of the display mode for all graphing of results in time or frequency domain. To change modes, click on the down arrow at the right of the field and click on the desired selection in the list which is displayed. The selections are Interpolate, Normal, and Peak.

If “Interpolate” is selected the DSP will compute the data value, interpolated from the nearby measured values. This smoothes out the “stair-step” appearance of frequency response curves at low frequencies with a Log horizontal axis, where the bin width (2.93 Hz at the 48 kHz sample rate) occupies a significant portion of the screen.

If “Normal” is selected the DSP will return the closest actual measured value without altering the data. Normal is the recommended display mode for frequency response data with a Linear horizontal axis or with a Log axis above 100 to 300 Hz. In these cases, the jagged lines caused by the FFT bin width are not usually noticeable.

The “Peak” mode will return the largest value between the last requested sweep point and the current one. Peak is recommended for time domain MLS displays (Impulse Response and Energy-Time). Peak mode would not normally be used for frequency response displays with MLS, since high values are of no more interest than low values when plotting frequency response.

## Trigger Source

---

The MLS process produces the impulse response of the device under test by correlating the signal from the device output with the generator signal into the device. Since MLS may be used on analog, digital, or mixed-domain devices (A/D and D/A converters, for example), the analyzer program must be instructed which generator signal should be used for the correlation. In the Trigger Source field, select Analog Gen when the analog generator is driving the device under test. Select Digital Gen when the digital generator is the MLS signal source.

## Save and Load MLS Waveforms

---

Saving waveforms from loading waveforms to the DSP and MLS program is possible, but with some detailed differences from the same feature with the other FFT-based programs. MLS places the impulse response resulting from cross-correlation of the transmitted and received signals into the Acquisition Buffer of the DSP. Therefore, the waveform that is saved to disk for later use is the impulse response of the device under test, not the original “raw” unprocessed samples. The option of saving only a shorter section of the impulse response does not exist. Only the entire length of the impulse response may be saved to disk.

While the impulse response is still present in the DSP buffers, full flexibility exists to change back and forth between time and frequency domain analysis (MLS Time vs. MLS Frequency at Source 1), to change start and stop times in order to view different time portions of the record, and to then perform FFTs of those selected time spans, to change Time Window selections, etc. The results of any and all of these different modes of analysis may be saved, one at a time, as .AT2C test files to disk. However, once the impulse response is gone from DSP memory, no further ability exists to analyze the signal other than re-loading test files to look at the specific analyses which were saved. If full flexibility for continued analysis is desired, the impulse response may be saved to disk, rather than merely saving .test files each of which represents one particular processed result of one type of analysis. The saved impulse response can then later be downloaded to the DSP Acquisition buffers for further analysis. Single-channel

waveforms saved at different times can later be individually loaded into the two channels of Acquisition buffer for comparison in the time or frequency domains.

## Saving Waveforms

Selected sections or the entire contents of the Acquisition buffers may be saved to a disk file by the File Save As menu command, selecting either the “Stereo Waveforms (\*.AAS)” or “Mono Waveform (\*.AAM)” as the Save As file type.

A Stereo Waveform file (.AAS) consists of two waveforms joined together into a single file. A Mono Waveform file (.AAM) contains a single waveform. To simultaneously save the waveforms from both Acquisition buffer channels, select the Stereo choice. To save only one of the channels, select Mono.

When the waveform file type is selected, a file name is typed in by the user, and the Save button is clicked, a dialog box as illustrated in Figure 16-4 will appear. The left half of the dialog box defines what will be saved into the first

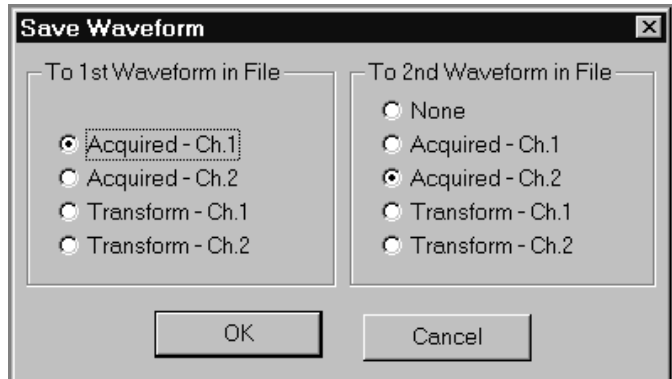

Figure 16-4 Save Waveform Dialog

section of a waveform file and the right half defines what will go into the second section. If Mono waveform was selected, the right half of the dialog is inapplicable and will be gray.

## Full Acquisition Buffer vs. Transform Sub-Section

As noted above, only the full buffer length may be saved from MLS.

## One vs. Two Waveforms

The selections in the left half of the dialog box determine which buffer contents go into a Mono waveform file or into the first section of a Stereo waveform file. The contents of the second section of Stereo waveform files are defined by the settings of the right half of the dialog box.

## Combining Mono to Stereo

It is possible to save single channel waveforms acquired at two different times and then combine them into a Stereo waveform so that simultaneous time or frequency domain analysis may be made for some “before and after” conditions. Save a Mono waveform from the first set of conditions, specifying the channel number where the desired data is presently located. Under different test conditions or with a different device under test, save another Mono waveform with a different name. Use the Open Waveform feature described below to load one of these waveform files into the Ch 1 Acquisition buffer and the other into the Ch 2 Acquisition buffer. Then, use the Save As command, select Stereo waveform and supply a new file name, and select the Ch 1 waveform into the first section and Ch 2 into the second.

It is also possible to use the DOS Copy command to concatenate two Mono waveform files into a new Stereo file. The command (from the DOS prompt) is:

```
COPY /B FILENAME1.AAM + FILENAME2.AAM NEWFILE.AAS
```

## Loading (Opening) Waveforms

Existing waveform files may be downloaded from computer disk to the DSP via the File Open command with its subsidiary selections of Stereo Waveforms (.AAS) or Mono Waveforms (.AAM). Selection of the desired waveform file name (after navigating to the desired directory, if necessary) and clicking the Open button then displays the Open Waveform dialog box as illustrated in Figure 16-5. The left half selections determine which DSP buffer the first section of the waveform file will be loaded into. The right half of the dialog (stereo

waveforms only) defines which buffer the second section of the waveform file loads into. Clicking OK then actually downloads the waveform file contents. After

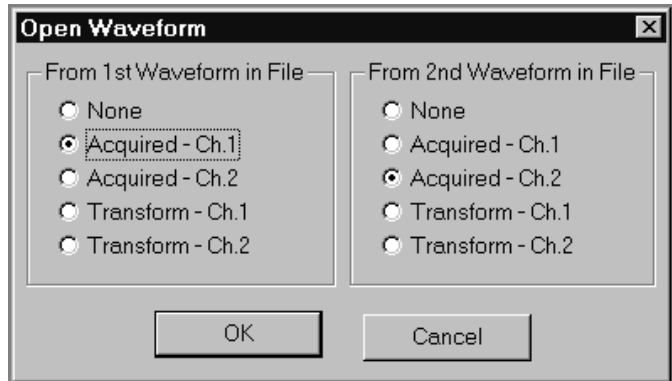

Figure 16-5 Open (Load) Waveform Dialog

the waveform is loaded, the **F6** and **CTRL F6** keys and settings on the MLS panel and Sweep panel may be used as described earlier for continued analysis of the waveform.

## Dual Channel Operation

The DSP hardware and MLS software are both capable of two-channel operation. Two independent A/D converters permit simultaneous acquisition of two analog signals. The digital interfaces are also of two-channel architecture. The input signal selection capability of the analog interface permits assigning a signal to one DSP channel and another related or completely independent signal to the other channel. The digital interface permits selecting the “A” digital signal channel as one signal and the “B” signal as the other. Both channels will be acquired, processed, and displayed when the **F9** key is pressed or “Go” is clicked. Both will be re-processed and displayed when the **F6** key is pressed.

It is also possible to acquire a signal into only one channel and then later acquire another signal into the other channel. If one of the two channel input selections is set to NONE, no signal will be acquired into that channel when **F9** is pressed. Conditions or devices may be changed to another desired test condition. Then, the originally-used input channel can be set to NONE and the desired signal source selected at the second channel, where no signal has yet been acquired. A second operation of the **F9** key acquires data into that channel but does not over-write data in the first channel. The data in both



channels will then be processed, transmitted to the computer, and displayed.

Signal in both channels will be processed according to the present settings on the MLS panel every time **F6** or **CTRL F6** is pressed. It is thus not possible to use different windows, different display options, or different time spans for the impulse response for the two channels. Thus, the loudspeaker-to-microphone spacing must be identical for the two signals if they are to be meaningfully analyzed in dual channel mode. Both sets of data must be acquired at the same sample rate. Processing will be done according to the rate selected at the time of pressing **F9**. If the data in one channel had been acquired at a different rate, it will be erroneously transformed or displayed with a resulting frequency error directly proportional to the difference in the two rates.

## Generator Sequence Length

When MLS is selected as Waveform on either the analog or digital generator of System Two Cascade, a pair of Sequence Length “radio buttons” are displayed, labeled 32k and 128k. The 32k sequences are identical to those generated in the System One MLS program and the System Two generator MLS waveforms. The 128k selection produces an MLS sequence four times longer. It is thus useful when testing large acoustical spaces with longer reverberation times; for example, the sequence length of a 32k sequence at a 48 kHz sample rate is about 680 milliseconds, and reverberations longer than that time will reduce the accuracy of MLS measurements. The 128k sequence at 48 kHz sample rate has a duration of almost 2.8 seconds and is usable in much larger rooms. The 128k sequence is also useful in order to maintain reasonable durations in normal-sized rooms as the sample rate is increased toward 96 kHz, since increasing sample rate reduces the time duration of a sequence of any given length.

## Matching Generator and Analyzer Sequences

The MLS analyzer automatically correlates to the MLS Sequence presently selected in the



Figure 16-6 MLS Sequence Length Buttons

Analog Generator waveform field if the Trigger Source is Analog Gen, or to the MLS Sequence on the Digital Generator panel if the Trigger Source is Digital Gen. If a sequence is recorded on RDAT or other digital tape for later measurement, it is important that the same sequence number be selected on the generator panel during playback of the tape, even though the generator is not then actually being used. Otherwise no impulse response will be obtained.

## Speed

The MLS Sequence Analyzer performs typical loudspeaker production tests very rapidly. Stimulus generation, acquisition, cross-correlation, and fast Fourier transform operations are all performed by the DSP module and are thus independent of computer speed. On the order of two seconds total is typically required for these functions. Transmission time of the data to the computer for graphing and/or limits comparison is computer-speed-dependent. The operating speed of MLS is identical whether evaluating a short section of the record for anechoic response or longer portions for integrated room response. The signal need not be re-acquired or re-correlated in order to evaluate response under both anechoic and wide-bandwidth conditions. The impulse response remains stored in DSP memory until a new acquisition is made.

## Advanced MLS Theory

### Impulse Response of Linear Systems

Any linear device or system may be completely characterized by knowing its impulse response. The impulse response is the output that results when the device under test is stimulated with an infinitely narrow pulse of infinite amplitude. In practice, if the stimulus pulse width is short compared to the length of the impulse response the measurements will still be accurate. This duration is typically 10 microseconds for audio frequency work. However, in spite of the short impulse duration, data must be acquired for the full length of time occupied by the impulse response of the device under test. This time is dictated by the lowest frequency desired in the measurement. An additional limitation which is usually more stringent is that the reverberation time of the space in which the measurements are

performed must allow the signal to adequately die out before another impulse may be generated.

The amplitude of the pulse will directly affect the amplitude of the output response. Since the allowable impulse amplitude is limited by the peak handling capacity of the device under test, the signal-to-noise ratio of impulse measurements is quite poor. For measurements on electronic systems this is typically not a problem. In loudspeaker or acoustic measurements the poor signal-to-noise of impulse measurements can be a severe limitation.

The impulse amplitude is limited by the peak signal-handling capability, but the energy in the test is represented by the RMS signal value. The energy directly sets the signal-to-noise ratio for any given background noise level. A single impulse has infinitesimal energy content, and so has very poor signal-to-noise ratio. Because of this, most engineers working with impulse test signals average the results of many impulses to improve signal-to-noise ratio. However, the impulse repetition rate is limited by the required acquisition time and reverberation time. If the impulses are coherently averaged and the noise is not synchronous with the impulse repetition rate, the impulses will reinforce each other and the interfering noise will tend to zero.

### **Impulse Response from Pseudo-Random Noise**

Pseudo-random noise can be viewed as a random sequence of impulses, some positive and some negative. This sequence repeats at a specific rate called the repetition rate of the noise. If the device under test is linear, the response to the pseudo-random noise will be the sum of the responses to the individual impulses. When these impulses arrive to be measured, the DSP effectively shifts each one in time to align them at the same point and averages them together. As long as the interfering noise is asynchronous to the signal, the noise will average out toward zero. The averaging operation creates a single impulse response that has lower noise than any of the individual impulse responses. The signal-to-noise ratio improvement is proportional to the square root of the number of impulse responses averaged. For the 32767-point pseudo-random sequence (15th order) used in the DSP, the noise improvement relative to a single impulse is 181 times or 45 dB.

In the frequency domain, pseudo-random white noise has a flat spectrum, with components spaced at the repetition rate of the noise. For a 32,767 point sequence operating at a 48 kHz sample rate the pseudo-random sequence will repeat every 0.68 seconds, or a rate of 1.46 Hz. White noise has equal energy per unit of bandwidth when analyzed on a linear frequency scale. The ear hears on a logarithmic scale (in fractions of an octave) and the spectrum of most interfering noise is also flat on a logarithmic frequency scale. Consequently, white noise produces more energy than is necessary at high frequencies and, conversely, less energy at low frequencies than is desirable. For example, in the octave band from 40 Hz to 80 Hz there will be 27 frequency components of the noise. In the octave band from 10 kHz to 20 kHz there will be 6849 components, 254 times as many or a power level about 24 dB higher. To compensate for this effect, the DSP software filters the test signal (above 80 Hz) with a pink filter that attenuates the higher frequency components in direct proportion to their number. The result is an equal power in each octave band, providing a more constant signal-to-noise ratio across the measurement frequency range. An exactly-complementary filter is used during the analysis stage to produce overall flat response.

## **Hadamard Transforms**

The cross-correlation operation required to shift the individual impulses in time and average them together is accomplished with a Fast Hadamard Transform.

For a description of the Fast Hadamard Transform and its application to MLS testing see Borish and Angell, “An Efficient Algorithm for Measuring the Impulse Response Using Pseudo-Random Noise”, Journal of the AES, Vol. 31, No. 7, July/August 1983, pp. 478-488.

For a description of a technique to simplify computation of the Hadamard Transform see Borish, “Self-Contained Cross correlation Program for Maximum Length Sequences”, Journal of the AES, Vol. 33, No. 11, November 1985, pp. 888-891.

## Frequency Response From Impulse Response

The impulse response is a time domain expression of the device behavior but most people find a frequency domain expression more useful. To convert the time domain display to a frequency domain display it is merely necessary to transform the impulse response into the frequency domain using a Fourier transform. The result of a Fourier Transform on a perfect impulse is a flat spectrum in the frequency domain. If the impulse is modified by the device under test its Fourier transform will be a display of the frequency response.

## Time Windows for Time-to-Frequency Transforms

The FFT algorithm is used to transform a segment of the impulse response into the frequency domain in order to see the frequency response. This segment is selected from the original impulse response by setting to zero all data outside the region of interest. If signal in the data record being transformed does not naturally decay to zero at the beginning and end of the segment, there will be sharp discontinuities introduced by the selection of this segment for transforming. These discontinuities in the waveform produce large amounts of high frequency energy in the transformed result. This high frequency energy results in ripples on the displayed frequency response curve.

To alleviate this problem, a “window” may be applied to the data. The idea behind a window is to gradually taper the data at both ends of the record toward zero so that it will always make a smooth transition with the following and preceding repetitions of the record. This is accomplished by multiplying each point in the data record by a mathematical function that is near unity (1.000) in the center of the data record and small at the ends of the record. The simplest such function is an inverted cosine wave raised above zero with an added DC offset so that its negative peaks just reach zero. After multiplication by the window function the data record goes to zero at the ends and so smoothly meets each data record on either side of the one being transformed. Multiplying the data by the window function does alter the spectrum of the original signal. As might be expected by visualizing the envelope of the repeating windowed data record, the frequency response will be smoothed. However, the spurious high frequency components produced by the sharp discontinuities will have

been eliminated. The raised cosine window described is called the Hann window after its inventor, Austrian meteorologist Julius von Hann. (It is often incorrectly called a Hanning window due to confusion with the “Hamming” window, named after its inventor Richard Hamming.)

The generic term window comes about because it restricts the view of the FFT to the central portion of the data record in much the same way that a window restricts the view of a person looking through it. There have been an endless variety of windows developed which trade off the spread in the spectral peak versus the ultimate attenuation of the spurious energy created by the ends of the data record. The sharper the roll-off in the skirts, the wider the peak must be in the passband. The bandwidth of the peak will be a specific number of bins for any given window. Increasing the length of the data record will reduce the bin width and therefore reduce the bandwidth in Hertz.

Transformation of impulse responses of loudspeakers is a special case, since the typical impulse has a fast rise and slow decay. Thus, it is desirable to use an asymmetrical window function which also has a fast rise and slow decay in order to taper values at the two ends of the selected portion to zero with minimal effect on the important information in the impulse. The window selection of MLS is therefore made up of two sections, each with its own panel selection field. The left-hand field on the TIME WINDOW line selects among four raised half-cosine choices, each corresponding to the first 180 degrees of a cosine and thus rising from zero at the beginning of the selected portion of record to a value of 1.00 later in the record. The right-hand field on the same line selects among four raised half-cosine choices, each corresponding to the last 180 degrees of a cosine and thus falling from a value of 1.00 late in the selected portion to zero at the end of the record. The nominal time selections (<5%, <10%, <20%, and <30%) refer to the percentage of the selected portion of the impulse across which the half-window makes its full transition. The “less than” sign < indicates that the actual percentage may be less than specified, since the actual number of samples for the transition from zero to unity (or vice-versa) will always be an exact binary power such as 4, 8, 16, etc. The DSP therefore rounds down from the selected value to the largest exact binary power within that value.

For example, assume a START time of 4 ms and a STOP time of 8 ms, resulting in a 4 ms time span. If the 48 kHz sample rate (20.8 microsecond sample period) is in use, there will be approximately 192 samples in the selected span. A START selection of <5% would nominally make the transition in the first 5% of the 192 samples, or 9.6 samples; the actual transition time will be rounded down to 8 samples as an exact binary power. Similarly, if <30% is chosen for the STOP selection, the nominal transition would take place during the final 30% of the 192 samples, or 57.6 samples. The actual transition time will be rounded down to 32 samples, the next lower exact binary power. All the data between the 8th sample from the beginning and the 32nd sample from the end will be unattenuated.

For an excellent technical discussion of windows and their characteristics see F. J. Harris, “On the use of Windows for Harmonic Analysis with the Discrete Fourier Transform”, Proc. of the IEEE, Vol. 66, No. 1, Jan 1978, pp. 51-83.

### **Frequency Windows for Energy-Time Displays**

The Energy-Time selection causes the DSP to transform the impulse response into the frequency domain, apply a frequency-domain window and Hilbert Transform to the complex frequency response, and then inverse transform the data back to the time domain to produce a plot of the estimated arrival of energy versus time. This “energy-time curve” is an approximation to the actual energy arriving at the microphone, since this energy can never be known without the simultaneous measurement of the velocity and pressure of the sound. Since the Energy-Time curve is computed from the pressure response alone it can never be complete.

The Time Start Window field selects the window function applied to the frequency-domain data when computing energy-time curves. The available window choices are No Window, Half Hann, Hann, <240Hz >8kHz, and <120Hz >16kHz. The Hann window, although used on other measurement equipment, yields inaccurate results because it excludes behavior of the majority of most device’s frequency range. The Half Hann, <240Hz >8kHz, and <120Hz >16kHz are preferable for most applications.

The first selection turns off windowing, allowing use of all frequency components of the arriving sound in the energy-time computation. The Half Hann selection uses a raised half-cycle cosine window which does not attenuate low frequencies but attenuates high frequencies above one quarter of the sample rate (approximately 12 kHz). The Hann selection uses a standard raised cosine window as provided on measurement equipment from other manufacturers. It centers its analysis on the energy around one quarter of the sample rate (approximately 12 kHz) attenuating both low and high frequencies. This yields inaccurate results on most devices because it excludes the behavior of the vast majority of the device's frequency range.

The last two window selections have been developed by Audio Precision to reduce the inaccuracies of the Hann window at both low and high frequencies while still reducing the window ripples which would occur if no window was used. These windows gradually roll off the spectral data above and below the frequency values specified in their labels. The <120Hz >8kHz window focuses the analysis between 240 Hz and 8 kHz by applying asymmetrical half-cycle raised cosine windows which attenuate below 240 Hz and above 8 kHz. The <120Hz >16kHz window shifts these frequencies by an additional octave to improve measurements of wideband devices at the expense of slightly more window rippling.

For an excellent technical discussion of the effect of windows on energy-time-curve computation see Lipshitz and Vanderkooy, "Uses and Abuses of the Energy-Time Curve", Journal of the AES, Vol. 38, No. 11, November 1990, pp. 819-836.





# Sync/Ref Input Panel

The Sync/Ref Input panel provides the ability to synchronize System Two’s master clock with several types of external reference signals. This capability is often needed when driving a digital input of an installation where “house sync” is used. System Two’s master clock may be synchronized to sample rate or frame rate of an AES/EBU reference signal, to the horizontal line frequency of NTSC, PAL, or SECAM video, or to a squarewave or other repetitive signal. These Sync/Ref panel features are described in the following sections.

The Sync/Ref Input panel can be brought to the screen by:

clicking on the Sync/Ref Input icon on the Panels Toolbar

or

selecting Panels Sync/Ref Input from the menu bar

or

from the keyboard, pressing **ALT** **P** **F** (for Panels sync/reE input)

The Sync/Ref Input Panel includes controls and displays relating to the rear-panel AES/EBU, video, and sine/squarewave reference inputs and

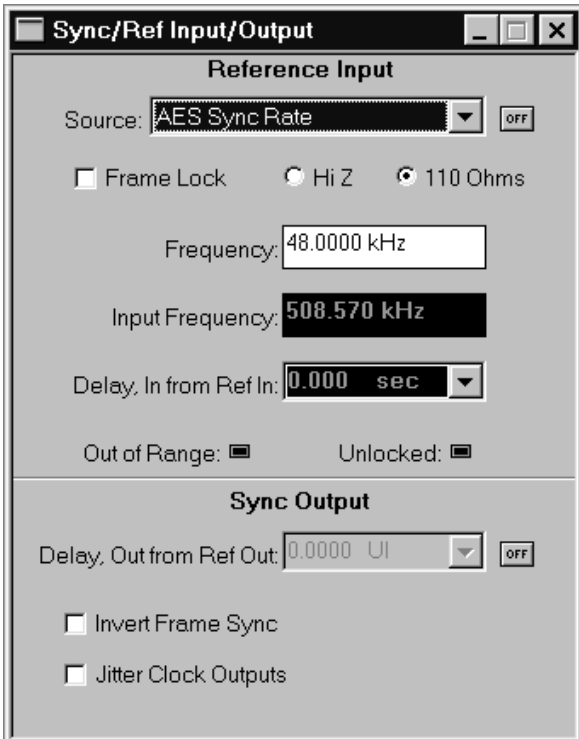

Figure 17-1 Sync-Ref Panel

outputs. They permit selection of:

- the input connector and format
- whether or not System Two is synchronized to the selected input signal
- whether frame lock or simple sample rate lock is required
- terminated or bridging resistance at the rear-panel reference input connectors
- specification of the reference frequency value to be used by the internal phase-locked loops
- setting of delay time of the digital generator with respect to the rear panel reference output signal
- inverting the polarity of output signal at the rear panel TRANSMIT FRAME SYNC BNC connector
- adding jitter to the rear panel MASTER CLOCK OUT BNC connector (if jitter injection is enabled on the DIO panel)

They permit measurement of:

- the sync/reference signal frequency
- the delay between front-panel digital input and the reference input.

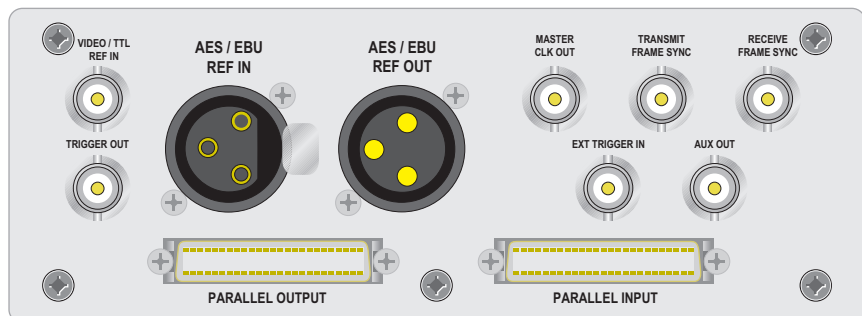

Figure 17-2 System Two Cascade DSP Rear Panel

Indicators also show whether the reference signal is within the range of proper phase-locking, and whether lock has been achieved.

## Sync/Ref Panel

### Sync/Ref Input Source and ON/OFF Control

An AES/EBU “house sync” signal (rear panel “AES/EBU REF IN” XLR), or the horizontal rate of a video signal in NTSC-PAL-SECAM format or a repetitive signal between 8 kHz and 10 MHz (rear panel “Video/TTL” BNC connector) may be used as a synchronizing input for System Two Cascade’s master clock. The master clock in turn controls System Two Cascade’s internal sample rate and is the reference for all System Two Cascade frequency measurements. In the case of an AES/EBU reference only, System Two Cascade’s digital generator frame and channel status blocks may also be synchronized to the reference input. The rear panel AES/EBU Reference Input signal may also be used as a reference for timing measurements of the front panel XLR, BNC, or Optical digital inputs. These sync reference signals are selected at the Source field at the top of the Sync/Ref Input panel.

When a source is selected and a suitable signal is present, the Input Frequency field will display the frequency of the input within three PPM.

The ON/OFF button at the right of the Source selection field connects the selected source signal to System Two Cascade’s internal phase locked loops. The Input Frequency field will be blanked when the switch is turned on, since the reading will be redundant if lock is achieved and will be incorrect if lock is not possible.

The proper reference source should be selected and the proper reference frequency typed into the Frequency field before the Source button is turned ON. When either of the two video sync functions (NTSC or PAL/SECAM) is selected, the normal horizontal sync rate for that video standard is automatically typed into the Frequency field. This value may be over-ridden by typing in other, non-standard values. However, values very near the standard value will be automatically rounded to the exact standard value. Phase noise on the reference

input below one or two Hz may impact the phase noise of the digital outputs due to the finite bandwidth of the phase lock loops.

### Frame Lock

---

Checking the Frame Lock box (AES Sync Rate selection only) causes the digital generator output to be synchronized with both sample rate and frame of the AES Reference input. Frame Lock is required for the Pass Thru “waveform” selections of the analog and digital generators to work properly.

### Sync/Ref Input Termination

---

A pair of “radio buttons” are displayed below the Source selection field. The buttons permit selection of a “Hi-Z” (bridging) or terminated value. The rear XLR and BNC sync inputs may be independently selected as bridging (Hi Z) or with the appropriate resistive termination of 110 Ohms for the XLR and 75 Ohms for the BNC. The termination value last selected for either input connector is retained across that connector even when the other connector is selected as the Sync Source.

### Sync Input Frequency Entry

---

The Frequency field on the Sync/Ref Input panel is a data entry field used to specify the exact Sync Input rate to be assumed by the internal phase-locked loop that controls the internal crystal oscillator. All internal sample rates are derived from the internal crystal oscillator. Normally, the user will enter the known reference frequency into the Frequency field. If the value entered here is slightly in error (less than 15 PPM) from the actual reference signal, lock will be achieved but all System Two Cascade sample rates will be in error by that percentage. If the value entered is more than 15 PPM away from the actual reference signal frequency, the internal crystal oscillator may not lock to the reference. When either of the two video sync functions (NTSC or PAL/SECAM) is selected, the standard horizontal sync rate for the selected video standard is automatically typed into the Frequency field. This value may be over-ridden by typing in other, non-standard values. However, values very near the standard value will be automatically rounded to the exact standard value.

## Sync Input Frequency Measurement

The Input Frequency field on the Sync/Ref Input panel displays the measured frequency (within the 3 PPM accuracy specification of System Two Cascade) of the signal selected in the Sync Source field if the Source button is OFF. This is intended as a verification of presence of a proper signal. Normally, the nominal value of the reference frequency will be known. For example, a display in this field of 47.9999 kHz almost certainly means the presence of a 48 kHz reference, and the value 48.00000 kHz should be entered into the Sync Input Frequency entry field before the button is turned ON.

## Delay, In from Ref In

The Delay, In from Ref In field on the Sync/Ref Input panel displays the time (phase) delay of the selected front panel XLR, BNC, or optical digital input connector with respect to the rear panel AES/EBU Reference (sync) input signal. This feature is not relevant with general purpose serial or parallel formats.

The “Delay, In from Ref In” measured value may be plotted on a graph as a function of some other parameter. To select “Delay, In from Ref In” in the browser for a Data “n” plot, select “Sync/Ref” as the instrument, and “In From Ref In Delay” as the parameter.

## Sync Unlocked Indicator

The Unlocked indicator on the Sync/Ref Input panel is lighted if the internal phase-locked loop is not locked to the sync input signal, indicating that the digital generator sample rate will not be locked to the reference. The indicator may require as much as several seconds to indicate an unlocked condition after the Source button is turned on.

## Sync Out of Range Indicator

The Out of Range indicator on the Sync/Ref Input panel is lighted if the actual Sync Input signal frequency is outside  $\pm 15$  PPM of the value programmed in the Frequency entry field on the Sync/Ref panel, or outside the amplitude range required for reliable operation. The indicator may require as much as several seconds to indicate an out of range indication.

## AES/EBU Reference Output

---

The rear panel AES/EBU REF OUT XLR connector on System Two Cascade Cascade Dual Domain provides a signal which may be used as “house sync” to a device under test. It carries an AES/EBU signal at nominal amplitude and at the Output Sample Rate (OSR). The imbedded audio is all zeros (“infinity zero”). Channel status bits indicate it as a Professional Grade 2 signal. The Local Address and Time of Day timers are fixed at zero, so the status bits repeat exactly from block to block and byte 23 (CRCC) remains at a fixed value. Origin code is set as “SYS2”. If the actual Output Sample Rate is near one of the three standard sample rates (32 kHz, 44.1 kHz, or 48 kHz), the status bits will indicate the proper sample rate. Any signal impairments such as jitter added to the front panel outputs will not affect this Reference output.

This signal serves as the reference against which the Output Delay from Ref field on the Sync/Ref panel controls the front panel output signal timing.

## Delay, Out from Ref Out

---

The Delay, Out from Ref Out field on the Sync/Ref input panel controls the time (phase) delay of the digital generator output relative to the rear panel AES/EBU REF OUT XLR connector. The REF OUT rear XLR connector would normally provide “house sync” to a device under test while the front panel digital generator output drives the device input. The Delay, Out from Ref Out value is then varied to determine the range of acceptability to the device. When delay is not required, this feature should be turned off via the On/Off button at the right end of the field rather than set to a zero value with the button On, since residual jitter is slightly higher when the output delay feature is on.

## Invert Frame Sync

---

The Transmit Frame Sync BNC connector on the rear panel carries a squarewave at the Output Sample Rate (OSR). In normal single connector output formats, this squarewave is at its positive value during the A sub-frame (normally left channel) and at its negative value during the B sub-frame. Checking the Invert Frame Sync box inverts this logic to negative during sub-frame A and positive during

sub-frame B. The purpose is for synchronization of oscilloscopes or other devices to a specific stereo channel.

### **Jitter Clock Outputs**

---

When jitter is injected into the front panel digital outputs by selecting anything other than OFF in the Jitter Generation field of the DIO panel Output section, this checkbox controls whether or not the rear MASTER CLOCK OUT BNC connector also has jitter added. Jitter on the MASTER CLOCK OUT connector would be desired in order to provide jitter via the SIA-2322 Serial Interface Adapter.





## Measurement Units

A number of different units of measurement are common in audio applications. For example, audio signal amplitude is frequently expressed in Volts, dBu, dBm, dBV, or dB relative to an arbitrary reference such as amplitude at mid-band or amplitude with normal signal level. Other units, although not common, can be very convenient and can reduce the data analysis and reporting tasks. Examples include amplitude in dBg (dB relative to the present value of generator output amplitude) or frequency expressed in octaves or decades with respect to a user-settable reference frequency.

APWIN software provides a wide range of selectable units for most measurements. Clicking on the down arrow at the right of a numeric display causes a list of the available units for that meter to appear. The user can then click on the desired unit. While the list is visible, the equivalent numeric values for each of the available units is displayed along with the unit. These values all represent the last measurement that the meter had displayed before the list was displayed, and the meter will not update while the list is displayed. The units displayed at the real-time numeric display of a particular meter on the instrument panel are independent from the units used to display that same meter in bargraph form or when the meter measurements are plotted on a graph. For example, a meter could be set for Volts units on the analyzer panel, dBm units in a bargraph, and dBu or dBr (relative dB) on an X-Y graph when sweeping, or several different bargraphs could all display the same meter measurement but each using a different unit.

### AC Amplitude units

The available analog domain ac amplitude units (although not all are available at all settings and meters) are:

**V** (Volts, Analyzer only). The analyzer meters that measure level or amplitude have the Volts unit available. The Level meters always use true RMS detectors. The main (Reading) meter offers a selection

of detectors including RMS, average, quasi-peak, and peak, so the value actually displayed depends upon the signal waveform and which detector is in use.

**Vrms** (Volts RMS, Generator only). The generator output may be set in Volts RMS. The calibration will be accurate only when a sine waveform is being transmitted. Other waveforms will be set to the amplitude that produces the same peak-to-peak value as a sinewave of the value set. **Vrms** is an open-circuit value and the actual terminal voltage will be less if a finite load resistance is connected.

**Vp** (Volts peak, Generator only). The generator output may be set in Volts peak. This calibration assumes a sine waveform is being transmitted, and is simply scaled to the **Vrms** value by the square root of two (1.414 . . .). Since non-sinusoidal waveforms are calibrated to have the same peak-to-peak value as a sinewave, the **Vp** unit should be correct for most non-sinusoidal waveforms. **Vp** is an open-circuit value and the actual terminal voltage will be less if a finite load resistance is connected.

**Vpp** (Volts peak-to-peak, Generator only). The generator output may be set in Volts peak-to-peak. This calibration assumes a sine waveform is being transmitted, and is simply scaled to the **Vrms** value by two times the square root of two (2.828 . . .). Since non-sinusoidal waveforms are calibrated to have the same peak-to-peak value as a sinewave, the **Vpp** unit should be correct for most non-sinusoidal waveforms. **Vpp** is an open-circuit value and the actual terminal voltage will be less if a finite load resistance is connected.

**W** (Watts, Generator or Analyzer). The Watts (power) unit is calculated based on the “V squared over R” relationship. In the Generator, the voltage division across the resistive divider made up of the generator source resistance and the resistance of the load must also be involved in the computation. Therefore, the resistance of the load must be accurately known and entered into the Generator Reference Watts field (on the large form of the generator panel). APWIN software will use that value and the selected value of generator output resistance to compute the voltage division ratio, and will then compute and set the required generator open-circuit voltage (emf) behind the output impedance to cause the set value of power to be dissipated in

the load. In the Analyzer, APWIN uses the Analyzer Reference Watts field value for  $R$ , measures  $V$ , and computes and displays power in Watts. The resistance value entered into the Analyzer Reference Watts field must be the net parallel resistance of all external and internal terminations. Since Watts is most commonly used in connection with loudspeaker impedance values that are typically under 16 Ohms, the analyzer input resistance of 100,000 Ohms may be neglected.

**dBm** (decibels relative to one milliwatt, Generator or Analyzer). The dBm is a power unit since its reference is stated in power terms (one milliwatt). It is calculated based on the  $V$  squared over  $R$  relationship in the load impedance. For Generator dBm units, the voltage division across the resistive divider made up of the Generator source resistance and the external load must also be known. Therefore, the resistance of the load must be accurately known and entered into the Generator Reference dBm field. APWIN software will use the Generator panel dBm Reference value and the selected value of generator output resistance to compute the voltage division ratio, and will then compute and set the required generator open-circuit voltage (emf) behind the output impedance to cause the set value of power to be dissipated in the load. As an Analyzer unit, APWIN measures and squares the voltage, divides it by the Analyzer panel dBm Reference value, and converts to decibels for display. The dBm Reference value entered must be the net parallel equivalent of all resistances involved including external circuitry and internal terminations selected in the Analyzer.

**dBu** (decibels relative to 0.7746 Volts, Generator or Analyzer). The reference value 0.7746 is the voltage across a 600 Ohm resistor when one milliwatt is being dissipated in that resistor. Thus, a dBu value will be numerically equal to a dBm value when the circuit or load resistance is 600 Ohms. When used for generator output, dBu is an open-circuit value and the actual terminal voltage will be less if a finite load resistance is connected.

**dBg** (decibels relative to generator, Analyzer only). The presently-programmed value of the generator output is the reference for dBg. This unit is particularly convenient during amplitude sweeps for detecting the threshold of compression of a processor or the clipping point of any device under test. dBg is computed with

reference to the amplitude command value to the generator and measurements in dBG therefore are subject to generator load resistance changes by the operator in addition to gain or input impedance changes in the device under test.

**dBr** (relative decibels, Generator or Analyzer). The reference value for dBr may be typed into the Reference dBr field (generators and analyzers have separate and independent Reference dBr fields), or the present value of measurement or generator output may be copied into the Reference dBr field by pressing the **F4** function key (or selecting the Edit Set Analyzer dBr Reference menu command) for the analyzer or the **F3** function key (or selecting the Edit Set Generator dBr Reference menu command) for the generator. As a generator unit, dBr is an open-circuit value and the actual terminal voltage will be less if a finite load resistance is connected.

**dBV** (decibels relative to 1.000 Volt, Generator or Analyzer). As a generator unit, dBV is an open-circuit value and the actual terminal voltage will be less if a finite load resistance is connected.

### **dBm vs. dBu Concepts**

The dBm unit (decibels relative to one milliwatt) is one of the oldest amplitude measurement units in professional audio and broadcast fields. Since a milliwatt is a unit of power, dBm is also a power unit. When the dBm unit came into common usage, audio equipment was normally transformer-coupled at both input and output and circuits were normally operated in a matched condition (output impedance of the driving device equals the input impedance of the driven device) for maximum power transfer.

However, audio measurement instruments today and through all the history of audio measurements are basically voltmeters, not power meters. Measuring power requires knowledge of both voltage and current, or both voltage and resistance, or both resistance and current. Since audio meters only “know” voltage, their utility in measuring in dBm units depends on them also “knowing” either the circuit resistance (impedance) or current. Older audio voltmeters almost invariably were calibrated based on the assumption that they would be measuring voltage across a 600 Ohm circuit. One milliwatt dissipated

in a 600 Ohm resistor produces a voltage drop of 0.774597 Volts. Thus, older meters with the dBm unit displayed were actually measuring voltage relative to 0.774597 Volts and were in error if connected across any impedance value other than 600 Ohms.

Modern professional audio and broadcast equipment is rarely operated in matched mode for power transfer. Instead, output stages almost always have very low impedance outputs, ranging from near zero up through a few tens of Ohms. Inputs of audio devices are nearly always “bridging”, meaning high impedance relative to the driving source. Common input impedances are 10 kilohms or more for most line input stages and perhaps 1500 Ohms for microphone inputs. Thus, the entire open-circuit voltage developed by the driving device is applied across the input, which essentially does not load it down.

The dBu unit has been in common use, especially in Europe, for more than a decade. dBu is decibels relative to 0.774597 Volts, and says nothing about power, impedance/resistance, or current. If the circuit impedance is 600 Ohms, dBu and dBm are numerically equal. If the impedance is not known, dBu still makes an accurate statement about the voltage.

System One and Two provide accurate dBm unit calibration for both generator outputs and analyzer inputs for any arbitrary circuit impedances, since the user can specify to APWIN software what the circuit impedance value is. For most modern applications, however, the dBu unit is to be preferred. In many cases, in fact, equipment manuals call for level setting in dBm units at values which are unachievable from that equipment. Clearly the equipment designers or manual writers were thinking in dBu even though the dBm term was used.

## Ratio Units

**%** the % (percent) unit expresses the ratio of two numbers, multiplied by 100. Thus, a ratio of 0.7 is expressed as 70.0%

**dB** the dB (decibel) unit is computed from the equation  $\text{dB} = 20 \log_{10} V$  measurement over  $V$  reference

**PPM** the PPM (parts per million) expresses the ratio of two numbers, multiplied by 1,000,000. Thus, a ratio of 0.00005 is expressed as 50 parts per million

**X/Y** the X/Y unit is the simple ratio between two numbers

## Frequency Units

**Hz** Hz (Hertz) is the basic frequency unit, expressing the number of total cycles of signal in one second

**F/R** F/R is a frequency ratio unit, obtained by dividing the measured frequency F by the reference frequency R

**dHz** (delta Hz) dHz is the difference in frequency between the measured frequency and the reference frequency (F - R)

**%Hz** %Hz is obtained by dividing the measured frequency by the reference frequency and multiplying the result by 100 ( $100 * F/R$ ). For example, a measured frequency of 950 Hz would be expressed as 95.0% of a reference frequency of 1 kHz

**cent** the cent unit is 1/100 of a musical half-tone interval, which in turn is the 12th root of 2

**octs** (octaves) an octave is a frequency ratio of 2:1. For example, with a reference frequency of 1 kHz, a 2 kHz tone is expressed as +1.0 octave and a 500 Hz tone is expressed as -1.0 octave

**decs** (decades) a decade is a frequency ratio of 10:1. For example, with a reference frequency of 500 Hz, a 5 kHz tone is expressed as +1.0 decade and a tone of 50 Hz is -1.0 octave

**d%** (delta %) d% is 100 times the ratio of the difference between the measured frequency and the reference frequency to the reference frequency ( $100 * (F - R)/R$ ). For example, with a reference frequency of 1 kHz and a measured frequency of 950 Hz, the d% value is -5%.

**dPPM** the PPM (parts per million) unit is 1,000,000 times the ratio of the difference between the measured frequency and the reference frequency to the reference frequency ( $1000000 * (F - R)/R$ ). For

example, a measured frequency of 1001 Hz with a reference frequency 1 kHz is 1,000 PPM.

## Phase Units

**deg** the degree is the basic unit of phase measurement, representing 1/360 of a complete revolution of phase.

## Digital Domain Amplitude Units

All four of the digital domain amplitude units refer to digital full scale (FS), a precisely defined quantity for digital audio signals. For 24-bit resolution numbers, positive digital full-scale is defined as 7FFFFFF Hex, negative full scale is 800000 Hex, and the zero signal baseline is 000000 Hex

Since digital domain amplitude calibration has been defined by the Audio Engineering Society in terms of the RMS value of a sine wave whose peaks just reach those maximum digital codes, it is possible to obtain readings greater than 100% FS (or 1.000 FFS or 0.00 dBFS or 0.00 bits) when measuring high-level signals whose crest factor is less than the crest factor of a sine wave. For example, since a sine wave has a crest factor of 3.01 dB and a square wave crest factor is 0.0 dB, a square wave touching the maximum digital codes will be displayed as 141.4% FS (1.414 FFS, +3.01 dBFS, or +0.5 bits).

**FFS** the FFS unit is fraction of full scale. At lower levels common in digital audio applications, they may be displayed as mFFS (milli fractions of full scale, or FFS/1000) and  $\mu$ FFS (micro fractions of full scale, or FFS/1000000)

**%FS** the %FS (percent of full scale) unit is FFS multiplied by 100. For example, a signal at 0.8 FFS is 80%FS

**dBFS** the dBFS unit is defined as  $20 \log_{10} * \text{FFS}$ . For example, a signal at 0.1 FFS is -20 dBFS

**bits** the bits unit is computed from dBFS and the relationship  $\text{bits} = 1.76 + (\text{dB}/6.02)$ . For example, a signal at 0.0001 FFS (-80 dBFS) is -12.99 bits.



## Time Units

**sec** seconds are the basic time unit. At values common in audio, the display may be ms (milliseconds) or  $\mu$ s (microseconds)

**UI** (Unit Interval) the Unit Interval may be used in timing measurements on the AES/EBU or consumer digital interface signal. A Unit Interval is 1/128 of the frame length (sample period). Thus, at a 48 kHz sample rate a Unit Interval is 162.760 nanoseconds and at a 44.1 kHz sample rate a Unit Interval is 177.154 nanoseconds.

**dBUI** (decibels referred to one Unit Interval). This unit provides a logarithmic unit, primarily used for FFT plots of jitter amplitude.

## DCX-127 Amplitude Units

**Vdc** Volts is the basic unit of DC (direct current) electromotive force

**f(V)** f(V) is computed from the basic Volts measurement and a scaling and an offset value. The equation is  $f(V) = \text{scale} * (V + \text{offset})$

## Resistance Units

**Ohms** Ohms is the basic unit of electrical resistance

**f(O)** f(o) is computed from the basic Ohms measurement, scaling, and an offset value. The equation is  $f(O) = \text{scale} * (\text{Ohms} + \text{offset})$

## DCX-127 Digital Input and Output Units

**dec** the dec (decimal) unit converts the DCX-127 digital input and output between binary and decimal representation

**hex** the hex (hexadecimal) unit converts the DCX-127 digital input and output between binary and hexadecimal

**octal** the octal unit converts the DCX-127 digital input and output between binary and octal

**g(x)** (input) the g(x) unit is computed from  $g(x) = \text{scale} * x$

**h(x)** (output) the h(x) unit is computed from  $h(x) = x/\text{scale}$

**18** units

## Sweeps and Sweep Setting

The Sweep panel and the Graph are closely related. The small version of the Sweep panel (which is the same size as the large version of the generator and analyzer panels) is used to select the parameter to be swept which is typically an instrument **Setting**, such as generator frequency or generator amplitude. However, the “swept” parameter may be a **Reading** of some input parameter from the device under test, such as the frequency of a

sequence of tones from a test tape, test CD, or remotely located generator. Using a Reading to control the process of measurements is called an **External Sweep**. Chart recorder-style measurements where one or more parameters on the Y axis are plotted versus time on the X axis are a specific form of External Sweeps called **Time Sweeps**. Sweeps of an internal setting are typically established by the user specifying start and stop values, number of steps, log/lin relationship, and permitting APWIN software to automatically compute the value of each intermediate step. It is also possible to use **Table Sweep** mode, in which each sweep setting value is looked up in a user-defined sweep table.

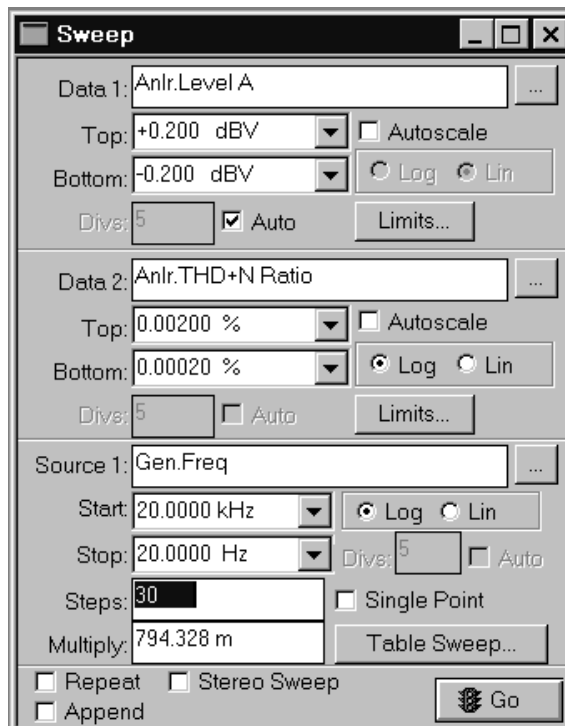

Figure 19-1 Sweep Panel, Small Version

The small version of the Sweep panel also permits selection of one or two parameters to be plotted, selection of auto-scaling mode, and control of characteristics of the graph such as horizontal and vertical scales, logarithmic vs. linear relationship, and number of divisions. The sweep panel also permits “attaching” upper and lower limits of acceptable performance to a sweep test. The large version of the Sweep panel permits adding up to four more traces, plotting measured data instead of the swept independent variable on the X axis, and setting up “nested sweeps”, where two parameters are swept in a coordinated fashion. The Graph displays all this data and provides methods of zooming in, returning to previous zoom levels, optimizing the graph scales to best fit the data, etc.

To bring the Sweep panel to the screen:

Mouse: click on the Sweep icon  on the toolbar, or select Panels Sweep via the menu bar

Keyboard: press    (for Panels Sweep).

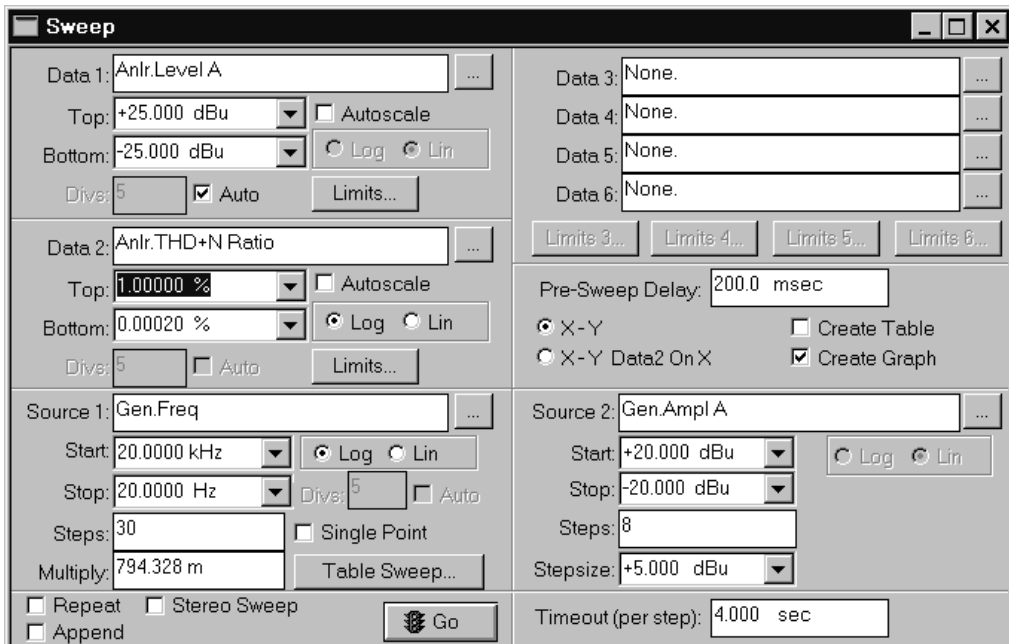



Figure 19-2 Sweep Panel, Large Version

The Sweep Panel can be displayed in small and large (double-width) versions. Clicking on the panel icon on the Panels Toolbar brings up the small version panel. Holding down the  key while clicking on the toolbar icon brings up the large version. To switch between the small and large panels:

Mouse: Double-click anywhere in the title bar.

Mouse: Click on the middle  of the three icons at the top right of the panel , in the control bar.

Keyboard: Press the  or  keys.

The normal default start-up mode of APWIN software shows the Sweep panel on the page two screen.

The small form of the Sweep panel is organized into three major sections—Data 1, Data 2, and Source 1. The Data 1 section controls the graphing of a dependent parameter, typically a measurement value, on the Y (vertical) axis with calibration at the left side of the graph. The Data 2 section permits a second dependent parameter to be plotted, with calibration at the right side of the graph. The Source 1 section controls the independent swept value, typically a stimulus parameter setting such as generator frequency or amplitude, and the X (horizontal) axis calibration of the graph.

## Source 1

Source 1 is the parameter that is deliberately changed as the independent variable during a sweep test, and normally provides the X-axis calibration of a graph.

To select a Source 1 parameter, click on the button with the ellipsis (three dots)  at the right end of the Source 1 field. A “Browser” box will be displayed.

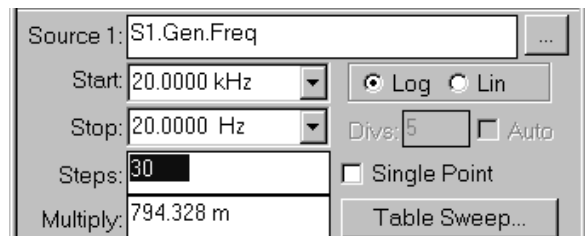

Figure 19-3 Source 1 Fields of Sweep Panel

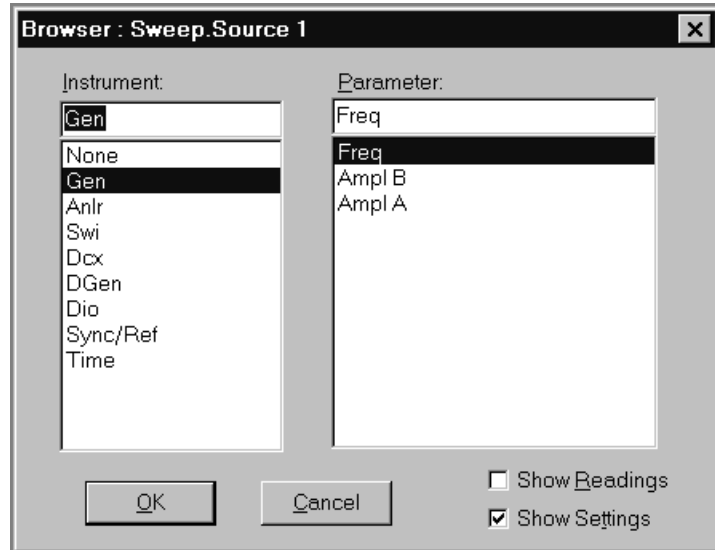



Figure 19-4 Source 1 Browser

In the Instrument column, click on the instrument module containing the parameter to be swept. The choices in the Parameter column change with the instrument module selected. The check boxes below the parameter column permit only readings, only settings, or both readings and settings to be displayed in the Parameter column. In the parameter column, double-click on the desired selection or click on the selection and click on OK.

## Sweep Range, Log/Lin

The range across which the independent variable is swept during a test and the sweep function (logarithmic versus linear) are controlled by the Start and Stop fields and the Log/Lin radio buttons.

### Start-Stop

Units selection and sweep start and stop value entries are made from the keyboard, followed by the  key.

### Log-Lin

If neither Start nor Stop value is zero or a negative number, the Source 1 axis may be calibrated on either a logarithmic or linear scale.

The Log-Lin buttons will be gray with linear selected if either value is zero or negative.

## Sweep Resolution

The span between the Start and Stop values will be stepped through in either equal size increments (Lin mode) or equal percentage increments (Log mode). The

number of steps, size of each step, log-lin selection, and span between Start and Stop values are interrelated. Only integer values are accepted in the Steps field. For any span, if a value is entered into the Steps, the span will be exactly divided into that number of equal (Lin) or equal-percentage (Log) steps which determine all intermediate values of the Source 1 parameter. The field immediately below the Steps field will display the

Step Size if a linear sweep or the step-to-step Multiplier if the sweep is logarithmic. It is also possible to specify a Step Size or Multiplier directly by entering a

value into that lower field. If the value entered does not result in an integer number of equal (lin) or equal-percentage (log) steps, the sweep will consist of N-1 steps of the exact value specified (where N = Steps value) plus a final, smaller step to the Stop value.

## X-Axis Divisions (Vertical Grid Lines)

On logarithmic axes, placement of graph divisions (grid lines) is pre-determined and the “Divs” field and Auto check box are gray and not functional. On linear axes, the user may specify a specific number of graph lines or divisions or may permit APWIN software to automatically select the number of divisions. To turn Auto division

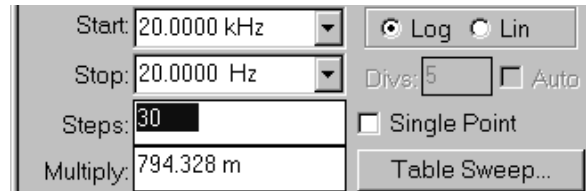

Figure 19-5 Log Sweep; Resolution Value is Constant “Multiply” Value

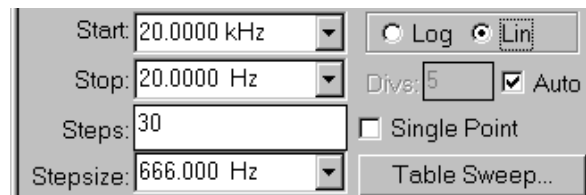

Figure 19-6 Lin Sweep; Resolution Value is Constant “Stepsize” Value



mode off and on (linear scales only), click on the Source 1 Auto division checkbox.

When the Auto division mode is off, a new # Divs value may be entered or the existing value edited from the keyboard, followed by pressing



Figure 19-7 Manual Setting of Number of X-axis Grid Lines

## Single-Point “Sweeps”

It is frequently desired, particularly in manufacturing test and quality assurance environments, to make single-point measurements rather than a swept series of measurements across a range.

To accomplish this with

APWIN, check the “Single Point” checkbox near the Go button at the bottom of the Sweep Panel. The Stop and Log/Lin control will become gray and the Steps and Multiply or Stepsize controls will disappear since they are irrelevant in a single point “sweep”. When Go is clicked or pressed, a single measurement will be made at the Start value entered in the Source 1 area of the Sweep panel. Since an X-Y graph cannot be drawn for a single point measurement, the Data table will automatically be displayed to show the one row of data when is pressed.



Figure 19-8 Source 1 Settings for Single-point Measurement at 1.0 kHz

## External Single-Point Sweeps

Single-point sweeps may be made with either a Setting parameter at Source 1 (such as Generator Frequency) or a Reading parameter (such as Analyzer Level or Analyzer Frequency). When a Reading parameter is selected, the Spacing field and the Min Lvl (minimum level) source and value fields appear, as they do for other sweeps with Source 1 selected as a Reading parameter (see External Sweeps on page 19-8). When GO is clicked or F9 is pressed, data will not be taken until the actual measurement of the Source 1 parameter is within the “Spacing” percentage of the Source 1 Start field value, and the Min

Lvl parameter satisfies the Min Lvl value. These features may be used to extract a single reading, or permit a procedure to continue, only when a measured parameter reaches a particular value. For example, a test tape or disc or distant-origination signal may include a stepped or swept frequency track following a track with a 1 kHz reference signal. The first test in a measurement procedure may be a Single Point External test with Analyzer Frequency selected as Source 1, 1 kHz entered into the Start field, and the default 5% Spacing retained. The procedure may be started but data will not be taken, regardless of the time delay, until the external signal frequency comes within 5% of 1 kHz. The measured level may then be retained and the next test setup of the procedure loaded to capture the frequency sweep data.

The external single-point feature could also be used to capture the frequency value when the measured amplitude reaches -3.0 dB relative to a mid-band value, thus automatically finding the -3.0 dB point of a filter.

Since an X-Y graph cannot be drawn for a single point measurement, the Data Editor should be displayed by selecting the Data Editor icon or expanding the Sweep panel to full size, checking the “Create Table” box, and un-checking the “Create Graph” box.

## Go button

The Go-Stop button starts or stops a sweep. The Go button has the identical function to the Go icon in the toolbar and the  function key. When a sweep is in progress, the button displays Stop and will stop the sweep if pressed. This is the identical function to the Stop icon in the toolbar.

## Single vs. Repeated Sweeps

Pressing the Go button or  function key will result in a single sweep from Start to Stop values, or a continuing succession of sweeps until the Stop button is pressed, depending upon the Repeat checkbox. When Repeat is checked, a continuous series of sweeps will result until manually halted. If Repeat is



Figure 19-9  
Repeat and  
Append  
Checkboxes

not checked, the sweep will automatically halt when the Stop value is reached.

Repeating real-time sweeps and graphs may be interrupted at any time by the Stop button or Esc key. Only the data taken since the start of the sweep will be retained in memory, Data Editor, and on the graph (unless the Append box was also checked). When DSP-based units are performing FFTs or multitone tests, repeating sweeps should be interrupted only by unchecking the Repeat box and letting the current acquire-transform-process-display cycle complete itself. Interrupting a repeating FFT sweep by the Esc key or the Stop button will result in invalid data in the DSP unit and a subsequent zoom, reprocess, or retransform command will result in meaningless graphs.

## Appended Sweeps

Any previous data will be replaced when a new sweep starts, or the new data will be appended to the existing data, depending upon the Append checkbox. When Append is checked, old data is retained and the new data is appended to it. When Append is not checked, old data is replaced whenever a new sweep starts. Note that data from a file on disk (test, limit, sweep table, EQ file, or data file) may be appended to existing data in memory by use of the File Append command, discussed in the Menus chapter.

## External Sweeps

It is frequently necessary to make and graph a series of measurements where some external, uncontrollable source is the independent variable. Common examples include frequency response measurements or other swept tests where the sweeping signal is pre-recorded on a test tape or test CD, or testing of a transmission link where a remote generator (not under control of APWIN software) is providing the signal. In these cases, APWIN software cannot control the values, direction of progression (high to low versus low to high), or dwell times of the signal. APWIN can, however, measure the

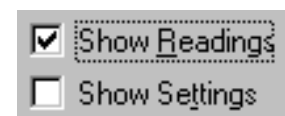

Figure 19-10 Readings & Settings Selection in Source and Data Browsers

changing parameter of the incoming signal (usually frequency but sometimes level) and use those measurements as the X-axis calibration. This mode of operation, where a measurement (Reading) drives the data-taking process and calibrates the X-axis, is called External Sweep.

**Readings** are measurements from an instrument. Examples include measured amplitude from a Level meter, measured Frequency from a Frequency counter, or measured Time from a clock. **Settings** are controllable values to which an instrument parameter can be set. Examples include generator amplitude, switcher channel number, or the type of dither sent to a digital output. To set up an External Sweep, Readings from an instrument suitable for measuring the parameter must be selected at Source 1, rather than the more conventional selection of a Settings parameter for an internal instrument. Thus, in the Sweep Source 1 Browser that appears when the Ellipsis button at the end of the Source 1 box is clicked, the “Show Settings” check box should not be checked and the “Show Readings” box should be checked. For swept-frequency measurements from a test tape or disc, for example, the Source Instrument selection might be an Analyzer (analog or digital as appropriate for the domain of the signal) with the selected measured Parameter as Frequency.

Sweep settling is operative during External Sweeps. Since the Source 1 parameter is also a measured parameter in External Sweeps, the Sweep Settling panel values for the Source 1 parameter must be appropriate for the signal being measured.

When a Reading parameter is selected at Source 1, several of the Source 1 control fields change. The Start, Stop, and Log/Lin controls remain, new fields appear for “End On”, “Spacing”, and “Min Level”, and the “Steps” and “Multiply/Stepsize” fields disappear since those parameters are determined by the external signal source. The discussion of External Sweep setup and operation is

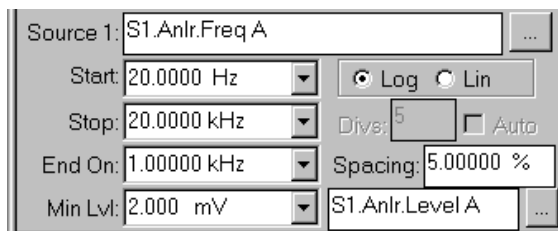

Figure 19-11 Source 1 Fields in External Sweep Mode (a Reading as Source Parameter)

organized into the following topics:

## **Start, Stop, and Sweep Direction**

---

The values entered in the Start and Stop fields at Source 1 on the Sweep panel not only determine the end values of the X-axis scale on the graph, but they define the sweep direction which APWIN software is expecting. If, for example, the Start value is 20 Hz and the Stop value is 20 kHz, APWIN expects the external signal to move continuously upwards in frequency. If the actual sweep direction of the external signal is opposite to the direction implied by the Start and Stop values, APWIN will not plot the measurements on the graph even though they are retained in memory and can be viewed in the Data table. The selection of Log or Lin only affects the X-axis calibration of the graph, with the actual progression through swept values being determined by the external signal.

## **Min Level**

---

The “Min Level” field in the Source 1 section of the Sweep panel permits the user to specify an input signal amplitude below which data will not be taken. On analog test tapes and analog disks, for example, there are frequently periods of “silence” between the test tones as the tape or disk plays through a series of tracks. However, “silence” in an analog medium may be only 40 to 60 dB below the recorded signal level. This may be a sufficient amplitude for the measuring instrument (usually the Frequency counter) to obtain occasional but spurious measurements that would result in nonsense points on the graph. By specifying a Min Level value less than the expected test tone level but above the expected noise level, the measuring and graphing process will be disabled during the interval between test tones. The measuring instrument for Min Level determination is selected in the field next to the Min Level value field. Click on the ellipsis button at the end of the field and use the Browser that displays to select the instrument and parameter to supply Min Level readings. Normally, the selection should be the Instrument and Level meter connected to the same channel as the Instrument whose Readings are selected at Source 1.

## Spacing

The “Spacing” field on the Sweep panel permits user control of how much the Source 1 parameter must change from its previous settled value before APWIN software will take another measurement set. If the Spacing value is set to too small a value, minor variations in the Source 1 parameter could result in multiple data points being measured for the same nominal value from the external signal. For example, momentary speed variations from an analog tape machine or analog disk player while playing a nominal 1 kHz tone could result in multiple measurements if the Spacing value were very small, such as 0.1% or less. If the Spacing value is too large, measurements will not be made from every value in a series of closely-spaced values of the external signal.

When the external signal continuously varies from its start to stop values (“glide tone”), the Spacing value determines the resolution of the measured sweep. Small values of Spacing cause APWIN software to capture measurements more frequently. Note that Sweep Settling parameters become more critical when the external signal is a “glide tone”. Typically the Points value for the Source 1 parameter (usually Frequency) will need to be reduced to “1” in order to capture measurements from a continuously-changing source.

## End On

The “End On” field in the Source 1 section of the Sweep panel permits the user who has advance knowledge of the external test signal to define a condition under which the sweep test will be automatically terminated at the end of the desired sweep data. This is important if an External Sweep test is one of a series of tests in a Procedure, since otherwise an External Sweep test is normally manually terminated by the user pressing the  key or clicking on a Stop icon when it is apparent that the sequence of test tones has ended.

The use of the “End On” field is based on the fact that many test tapes and test discs have a mid-band reference signal immediately following the end of a series of stepped-frequency test tones. Also, in the case of a remote System One or System Two generator supplying the signal for transmission testing, the remote generator can be set up

such that the generator dwells at its Generator panel setting (which can be a mid-band reference frequency) before and after a Source-1 frequency sweep. In either case, the swept parameter proceeds from some start value (usually a frequency at one extreme of the audio band) and moves to a stop value (usually at the other extreme), then reverses in direction to a mid-band reference value. If the value in the “End On” field equals the value of the swept parameter immediately following the last value of the sweep, and if that represents a reversal in the sweep direction, the test will be terminated and control will be returned to a procedure if a procedure is running. For example, if a test tape consists of a sequence of tones at 40 Hz, 100 Hz, 200 Hz, 400 Hz, 1 kHz, 2.5 kHz, 5 kHz, 10 kHz, 12 kHz, and 15 kHz, followed by another track of 1 kHz reference signal, the Sweep Panel should be set with a low frequency at Start, a high frequency at Stop, and 1 kHz entered in the “End On” field. As the tape plays through the increasing-frequency series of tones and then reverses the direction of frequency change from 15 kHz to 1 kHz, the test will automatically terminate, equivalent to pressing the  key or clicking on Stop.

## Time Sweeps

An External Sweep where measurements of time calibrate the X axis are called Time Sweeps. These produce “chart recorder” style measurements and are commonly used to measure instability and drift of audio parameters or to plot moment-to-moment variations such as wow and flutter as a tape is played, or phase jitter.

To set up a Time Sweep measurement, click on the ellipsis button at the right end of the Source 1 box on the Sweep panel. In the Browser that appears, select Time as the instrument.

As with other External Sweeps, check the “Show Readings” checkbox. Select “External Sweep Time” as the parameter and click the OK button.

You may now enter the desired Start and Stop times and either the number of Steps or Stepsize.

A number of factors determine when, and how close together in time, readings are actually taken. Sweep Settling introduces

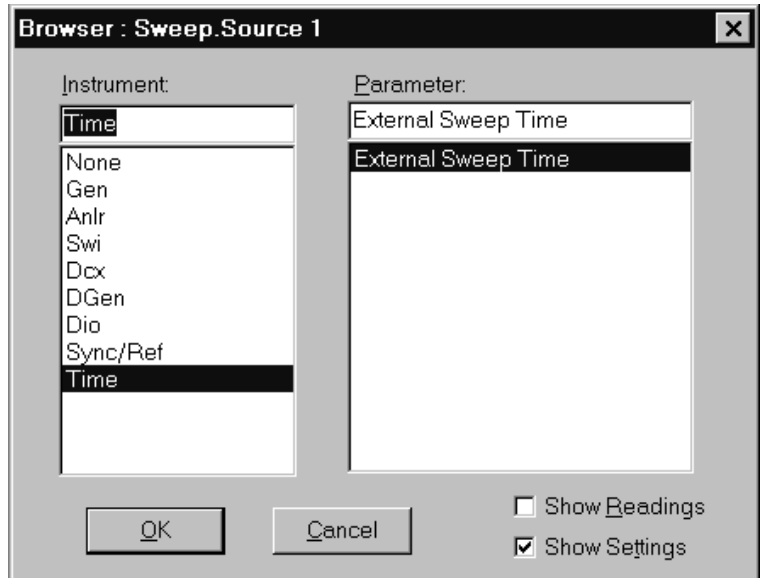

Figure 19-12 Source 1 Browser with Settings for Time “sweep” (Chart Recorder Mode)

considerable delay and variability in timing. Settling is often set to None for measurements such as phase jitter of wow and flutter versus time. The Reading Rate of the instrument plotted sets a minimum interval between readings. For example, at 8 readings/second, two consecutive readings cannot be closer than 125 ms. Windows and APWIN servicing of other panels and the graph or Data table (in Tabular display) slows down the ability to capture measurements close together. Thus, it is best to “kill” all panels, the graph, and the Data table, to be sure that the Utilities Configuration dialog is set for readings not to be active during sweeps, and to be sure that no other Windows applications are running when the most closely-spaced measurements are desired.

## Table Sweeps

Table Sweeps are sweeps where the Source 1 values are defined by a user-furnished tabular list of values from a “Sweep Table” or “Step Table” file (.ADS file type), rather than being internally computed from the Start, Stop, and number of Steps values on the Sweep Panel. A Table Sweep permits testing at arbitrary Source 1 values and use of



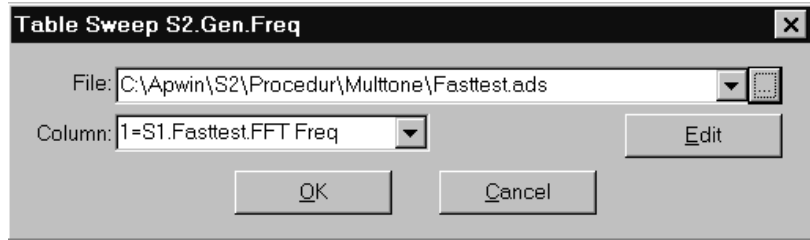

Figure 19-13 Table Sweep Dialog Box

exact, “round” numbers which is often desirable when converting older, manual test procedures to automation. The Start, Stop, and Log/Lin selections serve only to define the X-axis of the graph in Table Sweeps. Some actual Source 1 values could lie outside the graph X-axis end points, depending solely on the values in the table used. The sequence of values in a Table Sweep need not even be monotonic (progressing continuously in one direction), but can jump back and forth between any arbitrary values as long as they are within the operating range of the instrument setting parameter being varied.

Creation of a “Step Table” or “Sweep Table” file is accomplished in the Data Editor, with further editing (if required) normally accomplished in the Attached Files Editor. The same basic techniques are used to create Sweep Table files and Limits files. In a Sweep Table file, the column of data to be used must be the same parameter as the Source 1 instrument setting parameter that will be controlled. Thus, for a generator frequency sweep via Table Sweep, the Sweep Table file must have a column of frequency values. See the Limits chapter for information on how to create Sweep Tables.

Set-up of Table Sweep function is starting by clicking on the Table Sweep button just above the Go button, near the bottom of the Sweep Panel. Note that the Table Sweep button will not be visible if an External Sweep (an instrument Reading selected instead of a Setting) is set up at Source 1. The Table Sweep dialog and Browser will appear, as illustrated in Figure 19-13.

Clicking on the down arrow near the right end of the Files box will display a list of any Sweep Table files already associated with the present test, including their entire path names.

If the desired Sweep Table file name cannot be found on the displayed list, clicking on the Ellipsis button at the very end of the Files box displays a dialog permitting navigation to the directory (folder) which contains the desired Sweep Table, and selection of the specific Sweep Table (.ADS) file.

When the Sweep Table file has been selected, click on the down arrow at the right end of the Column box. A list will be displayed of the column numbers and column headings of the selected file. Choose the column whose data is to be used as the Source 1 values, and click on OK to make the selection. If you do not remember the exact column contents of the Sweep Table, click the Edit box in the Sweep Table dialog to display the entire contents of the Sweep Table file in the Attached File Editor, in order to properly select the desired column. It is also possible to change the value of points or add or delete rows to and from the Sweep Table via the Attached File Editor. If any values are changed, a warning message will be displayed upon leaving the Attached File Editor, pointing out that the revised version must be saved if the changes are to take effect. Displaying the Sweep Table contents in the Attached File Editor will cancel the Sweep Table dialog, so it will be necessary to click on the Table Sweep button again to select the column to be used.

Note that when the Table Sweep selections have been completed, the Stepsize or Multiply field, number of Steps field, and the Single Point checkbox all disappear since they are not relevant in Table Sweep mode. A single point Table Sweep can be created, if desired, simply by using a Sweep Table file that has only one value. Clicking Go will now produce a Source 1 sweep using the exact values from the selected column of the selected file as Source 1 values.

## Data 1 and 2 Selection

The Data 1 parameter is always plotted according to the calibrations of the left-hand graph vertical axis and Data 2 always plots against the right-hand axis unless the “X-Y Data2 on X” button on the large form of the panel is selected (see the “Plotting Measured Values X-Y” section later in this chapter. The color of the traces are initially assigned by APWIN defaults, but the defaults may be over-ridden by

user selections in the Graph Legend; see page 20-11. To select a Data 1 or Data 2 value, click on the button with the ellipsis (three dots) at the right end of the desired field.

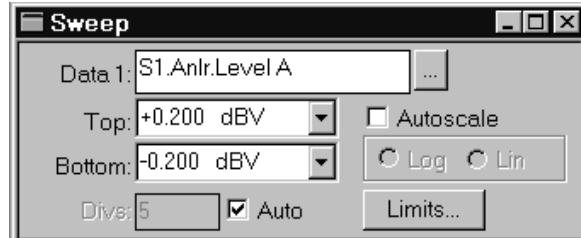

Figure 19-14 Data 1 Section of Sweep Panel

A “Browser” box will be displayed, illustrated in Figure 19-15. In the Instrument column, click on the instrument module containing the meter or parameter to be plotted. The choices in the Parameter column change with the instrument module selected. The check boxes below the Parameter column permit only readings, only settings, or both settings and readings to be displayed. In the Parameter column, double-click on the desired selection or click once and then click on OK.

## Top and Bottom

To select units and the graph top and bottom values, click on the down arrow at the right end of either the Top or Bottom field. Click on the desired unit in the list that appears.

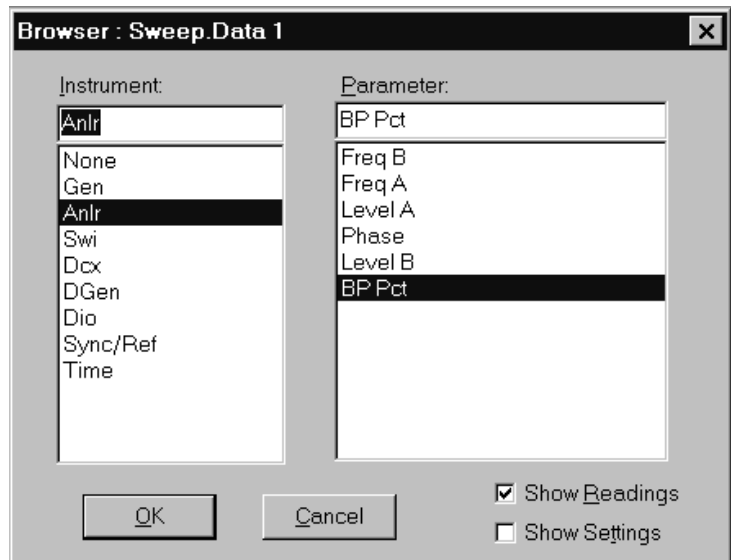



Figure 19-15 Browser Box for Data 1 Through Data 6

## Log-Lin

If neither the graph Top nor graph Bottom value is zero or a negative number, either Data axis may be calibrated on either a logarithmic or linear scale. The Log-Lin buttons will be gray with linear selected if either value is zero or negative. The Log-Lin buttons will also be gray if a decibel unit is selected.

## Number of Divisions (Grid Lines)

On logarithmic axes, placement of graph divisions (grid lines) is pre-determined and the # Divs field and Auto check box are gray and not functional. On linear axes, the user may specify a specific number of graph lines or divisions or may permit APWIN software to automatically select the number of divisions. When the Auto division mode is off, a new # Divs value may be entered or the existing value edited from the keyboard, followed by pressing .

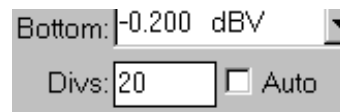

Figure 19-16 Manual Selection of Y-axis Grid Lines

## Autoscale

When Autoscale is not enabled, traces may plot off the top or bottom edge of the graph if the original Top and Bottom values were not properly chosen.

With Autoscale enabled, APWIN software will automatically increase the graph span as necessary to accommodate data values that exceed the originally-set graph Top or Bottom values. Autoscale mode only functions point-by-point as data values are acquired during a sweep; turning Autoscale on or off has no effect on data already in memory at the end of a sweep. (To optimize the graphic resolution for data already in memory following a sweep, use the Optimize function accessible by clicking the right mouse button on the Graph.)



Figure 19-17 Data 1 Autoscaling Enabled

## Limits

See the Limits chapter for complete information on attaching acceptance (Pass/Fail ) limits to a test.

## Data 3 Through Data 6

The large version of the Sweep panel controls the plotting of data parameters 3 through 6. Clicking on the panel icon on the Panels Toolbar brings up the small version panel. Holding down the  key while clicking on the toolbar icon brings up the large version.

### Plotting Data 3-Data 6

The Data 3 through Data 6 fields select parameters for the plotting of up to four traces in addition to Data 1 and Data 2 on the main Sweep panel. The color of the traces are initially assigned by APWIN defaults, but the defaults may be over-riden by user selections in the Graph Legend; see page 20-11. Since the Graph has only two Y axis calibrations (left and right), Data 3 through Data 6 can be plotted only if they share a “measurement domain” with either Data 1 or Data 2. For example, if Data 1 has been assigned to THD % and Data 2 to Level, it will not be possible to plot Phase at Data 3, 4, 5, or 6 since the two vertical axis calibrations are taken up by % and amplitude (Level) units. If it is desired to simultaneously plot the level on channels A and B and the phase difference between them, Phase must be assigned to either Data 1 or Data 2 so that either the left or right vertical axis displays phase units. If Phase is assigned to Data 1 and Ampl to Data 2, for example, Level B can then be assigned to Data 3 and will use the Data 2 units, log/lin selection, graph top and bottom, autoscale, optimize, etc.

If one or more of the Data 3 through Data 6 fields are in use, the Title Bar at the top of the small version of the Sweep Panel will list the active Data fields.

To select a parameter to be plotted in any of the Data 3 through Data 6 fields, click on the ellipsis button at the right of the desired Data field. The Data Browser



Figure 19-18 Sweep Panel Title Bar with Data 3 Active

box will appear. Click on the desired Instrument in the first column. The Instrument selection will determine which Parameters are available in the second column. Click on the desired Parameter, and click on OK.

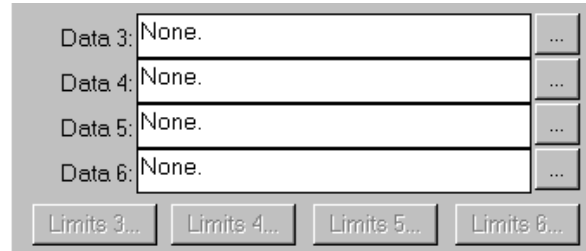

Figure 19-19 Data 3-6 Parameter and Limit File Selection Section, Large Version of Sweep Panel

## Stereo Sweeps

Stereo and two-channel devices are quite common in the audio field. System Two can measure certain parameters simultaneously on both input channels—for example, level on both channels or acquisition and FFT on both channels. Other parameters, such as THD+N, can only be measured on one channel at a time. In cases such as this, the Source 1 parameter must be swept twice with the appropriate analyzer input channel switching between sweeps. Stereo sweeps of parameters such as separation (crosstalk) require analyzer input channel switching between the two sweeps and also require corresponding switching of the generator output channel—drive A while measuring B, then drive B while measuring A. In any of these cases, measurement data from both channels will be combined onto a single graph in a single test file, with simplified sweep panel setup, by use of Stereo Sweep mode.

### Setting Up a Stereo Sweep

A Stereo Sweep is set up by:

- making the appropriate generator, analyzer, Sweep panel Source 1, and Sweep panel Data 1 settings to test one channel of the stereo device
- then checking the Stereo Sweep checkbox at the bottom of the Sweep panel (see the figure).

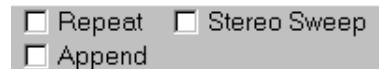

Figure 19-20 Stereo Sweep

When the Stereo Sweep box is checked, APWIN software determines which parameter is the “stereo twin” of the selected Data 1 value and writes that parameter into Data 3. Both traces will share the Data 1 (left axis) selections for units, graph top and bottom values, log/lin calibration, and number of divisions. The Stereo box cannot be checked if the Data selection is a parameter with no “stereo twin” (for example, if Phase or DCX-127 DMM Volts is selected at Data 1). If the Sweep panel is displayed in its large form when the Stereo Sweep box is checked, the “stereo twin” parameter in Data 3 will immediately be visible. If the Sweep panel is displayed in its small form, the title bar at the top of the panel will show that Data 3 is active, as shown in the figure.

APWIN also determines whether a single sweep is sufficient (when both parameters can be measured simultaneously) or whether the sweep must be repeated after switching input and output channels when necessary. When successive sweeps are required due to measuring a parameter which can only be measured on one channel at a time, both the digital and analog generator output channels and digital and analog analyzer input channels are switched if the instrument is a Dual Domain version.

When the Stereo box is un-checked, the Data 3 parameter is automatically removed and only a normal, single sweep will result.

### **Stereo FFTs Following the Analog Bandreject Filter**

When the test signal from an analog-output device is a single sinewave, it is extremely useful to process the signal through the THD+N function of the Analog Analyzer Function Reading meter before converting it via the A/D converters for FFT spectrum analysis. The bandreject filter attenuates the fundamental by typically 120 dB or more and adds typically 60 dB of calibrated gain before feeding the A/D converters. In effect, any distortion generated in System Two's A/D converters is moved down 60 dB relative to the distortion and noise products from the device under test. Since System Two's Analog Analyzer has only one bandreject filter, FFT measurements following the filter must be made sequentially on the two channels. To set up such a test, select FFT Chan 1 Ampl at Data 1 and FFT Freq at Source 1. On the FFT Spectrum Analyzer panel, select Anlr Rdg Ratio or Anlr

Rdg Ampl as the Channel 1 Source and “None” as the Channel 2 Source. Then, check the Stereo Sweep checkbox. When the measurement is initiated, FFT Channel 1 will first acquire signal from the bandreject output while the bandreject is driven from the analog analyzer Channel A signal. The Analog Analyzer input will then automatically be switched to Channel B, the Anlr Rdg and the “None” selection will be automatically interchanged on the FFT Spectrum Analyzer panel, and a second acquisition and FFT will be made. The result is overlaid FFTs of the two channels, each following the notch filter. See the furnished test file C:\APWIN\S2CASCADE\A-A\A-A FFT OF THD+N RESIDUAL.AT2C for an example.

## Stereo Sweeps and Limits

If a limit file (.ADL) is selected at Data 1 or 2 before the Stereo box is checked, the Data 1 limits will automatically be used at Data 3 and the Data 2 limits will be used at Data 4. If it is desired to use a different limit file or no limits at Data 3 or 4, the Limits buttons for Data 3 and 4 (large version of the Sweep panel) may be used to change or disable the automatic selection. For more information on creation and use of Limits files, see the Limits chapter.

## External Stereo Sweep

External sweeps, as discussed earlier in this chapter, are used to make swept measurements and graphs from an external, uncontrollable signal source such as a pre-recorded test tape or compact disc or a remote, sweeping oscillator. To make an External sweep of a stereo device, set up the Source 1 and Data 1 areas as described in the External sweeps section. Then, check the Stereo checkbox. The “stereo twin” of the Data 1 parameter will be written into Data 3 as described earlier.

If the parameters at Data 1 and 3 can be measured simultaneously, the External stereo sweep will then proceed exactly like a single-parameter External sweep. If the parameter to be graphed is one that can only be measured on one channel at a time (such as THD+N), a different form of sweep logic is used. The parameter will first be measured on the channel selected on the analyzer panel and plotted as Data 1. Then, the analyzer input will be switched to the opposite channel and the resulting measurement plotted as Data 3.



The analyzer input is then switched back to the original channel and the Source 1 parameter is monitored, awaiting a change of at least the Spacing value before measuring another pair of points. This switching logic is based upon the fact that the measurement system is typically able to measure both channels in less time than the typical test tape or disc dwells at each frequency. Thus, a single pass through the recorded or remotely-originated sweep is sufficient to produce measurements of both channels even on parameters which must be measured one channel at a time.

If the rate of change of Source 1 parameter is an External Stereo sweep is so fast that the analyzer has not completed a settled measurement on the second channel before the Source 1 parameter steps to its next value, no Data 3 trace will be plotted. If the Data table is used to examine the data in tabular form, the symbols “—B” will be displayed in the cells that contain bad data. If cursors are used on the graph trace with missing values due to an excessively-fast sweep, the cursor readout box will show “—” and the delta-Y display box will disappear if the cursor is moved to one of the bad values.

## Pre-Sweep Delay

The Pre-Sweep Delay field, on the large form of the Sweep panel, permits establishment of a minimum stabilization time at the start point of a sweep before taking the first measurement. This permits possible transients in the device under test and the Source 1 generator to decay in order to eliminate “glitches” at the start point of a sweep.



Figure 19-21 Pre-Sweep Delay Field

## Plotting Measured Values X-Y

The large version of the Sweep panel permits plotting measured parameters on the Y axis versus another measured parameter on the X axis. Select the “**X-Y Data2 on X**” choice rather than “X-Y” which is the common mode for conventional graphs. With “X-Y Data2 on X” selected, the Data 1 parameter will be plotted as a Y axis displacement

versus Data 2 measurements on the X axis. Data 2 values will calibrate the X axis and the Source 1 values and calibration will not be displayed on the graph at all. Source 1 will still be the independent variable, stepping through the range defined, and driving the test to create the changes in Data 1 and Data 2 variables that will be plotted.





Figure 19-22 Plotting Data 2 on X Axis

Changes between conventional X-Y mode and X-Y Data2 on X may be made freely before or after a test is run, or even with a test file re-loaded from disk. Note that limits cannot be graphed nor data compared to limits when the graph is in X-Y Data 2 on X mode.

## Data Display Mode

Sweep test results may be displayed in real time either on an X-Y graph or as numbers in a table (or both). The Create Graph and Create Table checkboxes determine which forms of display will be used if neither is already visible on the current Workspace page when  is pressed.

If **Create Graph** is checked, APWIN software will automatically display a graph when  is pressed and will plot onto that graph.

If **Create Table** is checked, the Data table will automatically be displayed when  is pressed and the data will be presented in tabular fashion in the Data table with the data appearing line by line as the sweep progresses. Since there is no issue of insufficient graph vertical axes available for calibration with tabular display, it is possible to have up to six data parameters of any mixture of unit domains (Volts, Hz, %, dB, etc., etc.) simultaneously displaying during a sweep with Tabular display..

If both boxes are checked, both forms of display will automatically be created. If neither checkbox is checked, the data is still taken and, if limits are in use, compared to limits for Pass/Fail decisions. This “no display” mode is actually the fastest and may be desirable in manufacturing test situations.

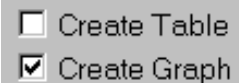

Figure 19-23 Display Mode Controls

## Source 2 and Nested Sweeps

The large version of the Sweep panel permits “nested sweeps”, where a second parameter is stepped between repetitions of the Source 1 sweep. Clicking on the panel icon on the Panels Toolbar brings up the small version panel. Holding down the **SHIFT** key while clicking on the toolbar icon brings up the large version. If the Source 2 field is in use, the Title Bar of the small version of the Sweep Panel will indicate the fact.

A nested sweep controls two different settings parameters in an inter-related manner to produce a family of traces on the Graph. Examples include sweeping generator frequency at Source 1 and generator amplitude at Source 2 to produce a family of frequency response measurements at different levels, or sweeping generator frequency at Source 1 and switcher channels at Source 2 to produce overlaid frequency responses for many channels of a multi-track tape recorder or mixing console. The X-axis calibration and labeling of the graph is determined by the Source 1 parameter. The Source 2 parameter values are not intrinsically visible from the traces, but the Graph legend will display Source 2 values at the cursor locations along with the Data and Source 1 values. The sequence of sweeps is as follows: select the Source 2 Start value, and sweep through the Source 1 range from Start to Stop. Step the Source 2 parameter one step and sweep Source 1 again. Repeat for each defined step of Source 2, concluding the test by sweeping the Source 1 range at the Source 2 Stop value.

The Source 2 and Source 1 Browser operate identically. See the Selection of Parameter to be Swept (Independent Variable, Horizontal Axis) Topic for set-up instructions.

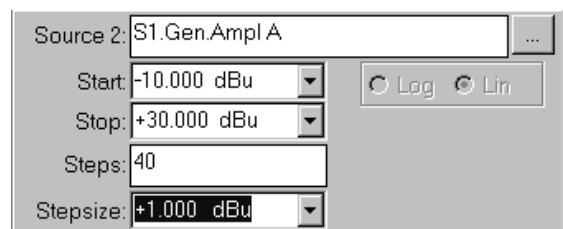

Figure 19-24 Source 2 Section, Large Version of Sweep Panel

## Timeout

As discussed in the Sweep Settling Panel section starting on page 10-27, settling algorithms are normally used during sweeps to assure that the data values have settled after any initial transients caused by the sweep so that measurements are repeatable. However, it is possible that the instability of the measured parameter is greater than the Tolerance value present used in the Sweep Settling algorithm. For example, if a Tolerance of 1% (about 0.1 dB) were in use while measurements were made of noise or an extremely noisy signal, it might never be possible to obtain the required number of consecutive points within 1% of one another in amplitude. The result could be complete failure to make a measurement (software hang-up) or, at the minimum, greatly slowed measurements.



*Figure 19-25 Settling Timeout Field, Large Version of Sweep Panel*

The Timeout parameter is intended as a “safety valve” to avoid such hang-ups. At any attempted measurement point where settling has not been achieved within the time value specified in the Timeout field, APWIN software will compute the numerical value of the last six measurements, plot that value on the graph or display it in the Data table, and step on to the next point of the sweep. In a graph display, each timeout point is indicated by a white “T” at the upper margin of the graph, directly above the plotted point. In the Data table, each timeout point is indicated by the letter T following the data. In the Log File, the Pass/Fail message (if enabled) shows the total number of timeouts that occurred during a sweep and indicates “FAILED” if there were one or more timeouts, even though the eventual averaged data may have been within limits. The Log File (unless “None” is checked under “Sweep Data”) also includes a line for each measured point that timed out result in a row showing the measured value and a letter T.

## Settling Panel

Measurements by most meters in the instrument are taken continuously, often at rates as rapid as 32 or 64 readings per second. The real-time numeric meter displays and bar graphs show “raw”

un-settled data, with every measurement made by the meter being displayed on the panel. If transients, noise, or other momentary events affect a reading, the operator may choose to ignore the transient.

During a sweep, each change in stimulus amplitude or frequency introduces transients into the device under test, the generator, and the analyzer. Plotting such un-settled data usually results in jagged, unrepeatable graphs of doubtful value. Repeatable data is normally desired, taken after the device under test and the measuring instrument have settled to near-steady-state conditions. To obtain repeatable results, settled data must be used.

Settled data is normally obtained in APWIN by discarding early measurement points polluted by transients and plotting only the later, repeatable values after the device and instrument stabilize. The Sweep Settling process determines when data has stabilized sufficiently following a transient so that a point may be plotted and the sweep permitted to move on to the next step. The key Sweep Settling parameters are under user control via the Sweep Settling panel.

To bring the Settling panel to the screen, click on the  icon, select Sweep Settling under the Panels menu, or select Show Settling Panel under the Sweep menu. The Sweep Settling panel is illustrated in Figure 19-26.

## Settling Concepts and Algorithms

The general concept of the Sweep Settling Exponential and Flat algorithms is to discard all meter readings during the Delay interval, then to compare the number of successive meter readings equal to the “Points” value against the Tolerance or Floor values. Only when the specified (Points) number of consecutive meter readings agree with one another within the specified Tolerance or Floor values will the data be considered stabilized. It is then accepted for plotting and the Source parameter permitted to proceed to the next step.

If the **Exponential** algorithm is selected, the newest reading (N) must agree with the immediately preceding reading (N-1) within the Tolerance value, with the reading before (N-2) that within twice the

Analog Analyzer						
	Tolerance	Floor	Points	Delay	Algorithm	
Amplitude	3.00000 %	100.0 nV	3	30.00 msec	Flat	
Level A:	1.00000 %	10.00 uV	3	30.00 msec	Flat	
Level B:	1.00000 %	10.00 uV	3	30.00 msec	Flat	
Frequency A:	0.50000 %	250.000 uHz	2	20.00 msec	Flat	
Frequency B:	0.50000 %	250.000 uHz	2	20.00 msec	Flat	
Phase:		+0.20 deg	2	20.00 msec	Flat	
DCX						
DCV	0.20000 %	+0.00050 Vdc	3	30.00 msec	Flat	
Digital In:	0.00000 %	0 dec	3	30.00 msec	Flat	
DIO						
Sample Rate:	0.50000 %	100.000 mHz	3	30.00 msec	Flat	
Voltage:	3.00000 %	10.00 mVpp	3	30.00 msec	Flat	
Delay, In from Ref In:	0.01000 %	70.00 nsec	3	30.00 msec	Flat	
Delay from Out:	0.01000 %	70.00 nsec	3	30.00 msec	Flat	
Interface Jitter:	3.00000 %	3.000 nsec	3	100.0 msec	Exponential	
DSP Audio Anlr.Level A	1.00000 %	1.000 uFFS	3	30.00 msec	Flat	
DSP Audio Anlr.2 Channel	1.00000 %	1.000 uFFS	3	30.00 msec	Flat	
DSP Audio Anlr.Freq A	0.50000 %	10.0000 mHz	3	30.00 msec	Flat	
DSP Audio Anlr.Level B	1.00000 %	1.000 uFFS	3	30.00 msec	Flat	
DSP Audio Anlr.Freq B	0.50000 %	10.0000 mHz	3	30.00 msec	Flat	

Figure 19-26 Sweep Settling Panel (DSP Audio Analyzer Loaded as Digital Analyzer Program)

Tolerance value, with the reading before that (N-3) within four times the Tolerance value, etc. Figure 19-27 shows the “envelope” within which a succession of readings must fit if Tolerance is set to 1%. Exponential is the recommended settling algorithm for most audio applications, since typical device transients tend to die away in an exponential fashion. Exponential thus will usually provide repeatable results to the Tolerance acceptable to the user in the minimum length of time.

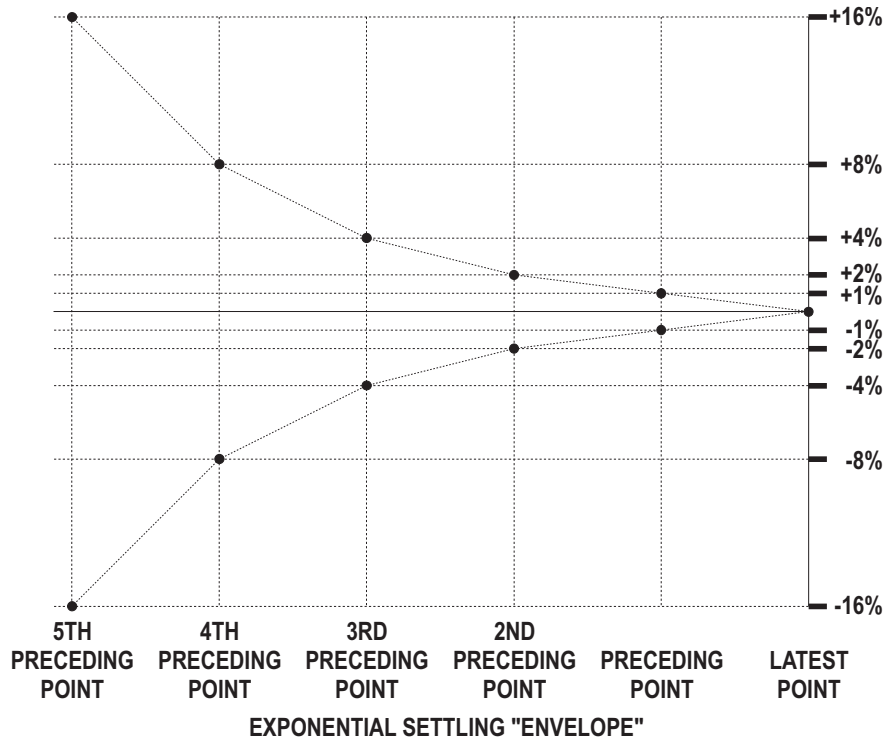

Figure 19-27 Graphic Representation of Exponential Settling Criteria, 1% Tolerance and 6 Points

When the **Flat** algorithm is selected, the percentage difference between each set of two consecutive readings (N vs. N-1, N-1 vs. N-2, etc.) must be equal to or less than the specified Tolerance value, through the number of readings specified as the Points value. Illustrating the Flat algorithm for 1% Tolerance would result in an “envelope” bounded by two horizontal lines at the plus and minus 1% levels across the full number of Points. The Flat algorithm thus guarantees that the transients have been settled to the specified Tolerance for some time, which tends to take longer than the Exponential algorithm.

When the **Average** algorithm is selected, points are first discarded for the duration of the Delay interval, as with Exponential and Flat. At the conclusion of the Delay period, the number of consecutive readings specified in the Points field is accumulated and their average value computed and plotted. Tolerance and Floor values are ignored

when Average is selected. The Average algorithm is particularly useful when the signal is fundamentally noisy and might never settle within a practical Tolerance.

When **None** is selected as the algorithm, no settling process takes place for that meter. Measurements such as wow and flutter or phase jitter are examples of cases where no settling should be used, since it is desired to see the extreme variations in measurements.

### Algorithm Selection

To change the algorithm used for any meter, click on the down arrow at the right of the Algorithm field. Click on the desired selection in the list that appears.

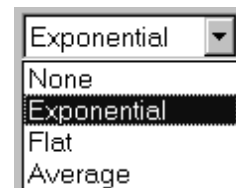

Figure 19-28 Settling Algorithm Selections

### Tolerance and Floor

The settings of any Tolerance, Floor, Points, or Delay field may be entered or edited from the keyboard. The Tolerance value that should be entered is the amount of variability the user is willing to accept from test to test. A Tolerance value of 0.1% (about 0.01 dB) or even slightly smaller may be appropriate when making frequency response measurements on the test system itself or on an external device known to be very flat and being measured under excellent signal-to-noise conditions. At the other extreme, Tolerance values of 10% to 25% (1 to 2 dB) may be required to obtain data under noisy conditions, or when making measurements with a random noise signal as the stimulus. The default value of 1% (about 0.1 dB) is a good starting compromise for most level measurements.

The Floor value is used by the algorithms instead of the Tolerance value whenever the Floor value is larger. When the measurements values are greater than a few percent of full scale on the instrument range in use, the Tolerance value is normally the determining parameter. If the measurements are very near the bottom of the instrument's dynamic range, use of only a Tolerance parameter could result in a "hang up" situation, since the percentage difference between



two adjacent values (quantization levels) at the bottom of a meter's range is large. The Floor parameter thus serves as a “safety valve”, avoiding slowing or hang ups in the highly resolution-limited situations where the signal is near the bottom of a measurable range. The default values of Floor for each meter are chosen to be approximately the resolution of that meter on its most sensitive range. Since resolution varies with reading rate (slower reading rates give more resolution), it may be appropriate to change the default values when reading rate is fixed at a given value.

## Delay

---

The Delay value is effective even when the Algorithm selection is “None”. The Delay time will be taken at the beginning of each nest of a nested sweep, including nested FFT measurements with the FFT at Source 1 and another parameter such as generator amplitude at Source 2. Acquisition of signal into any of the FFT programs will not begin until the Delay value (or 200 milliseconds, whichever is greater) has passed. For Time sweeps where it is desired to make as many measurements per second as possible, the Delay value should be set to zero in addition to selecting “None” for settling.

## Settling Parameter Independence Among Instruments

---

The settling for each meter in the System is independently controlled by its own row of fields on the Sweep Settling panel. All meters except the Phase Meter have fields for Tolerance, Floor, Points, Delay, and Algorithm. The Phase Meter does not have a Tolerance field and the variability acceptable to the user should be entered into the Floor field. The Reading Meter settling parameters on the top row are displayed only for the Reading Meter function presently selected on the Analog Analyzer panel.

## DSP Measurement Settling

---

The Settling concept does not apply to “batch mode” DSP-implemented measurements where a signal is acquired into memory, an FFT performed, and results graphed. Settling parameters for real-time DSP functions are displayed near the bottom of the

Settling panel only for the DSP function presently selected on the Digital Analyzer panel.

Reading Meter and DSP function settling parameters are stored independently for each function. If, for example, different settling parameters are preferred for Amplitude and THD+N, it will not be necessary to re-enter them as the function is switched back and forth.



## Graphs and Printing

The parameters selected on the Sweep panel may be graphed as X-Y relationships by APWIN. The Graph window may be re-sized by dragging any corner or edge. The Graph may be displayed on more than one page and at different sizes on different pages, but the content is identical in all instances.

The user may zoom in, repeatedly if desired, on areas of the graph by dragging with the left mouse button. Zooming back to previous views, optimization of the plot, turning cursors on and off, and several other graph operations are controlled by a dialog box (see Figure 20-2) which appears when the **right** mouse button is clicked anywhere on the graph.

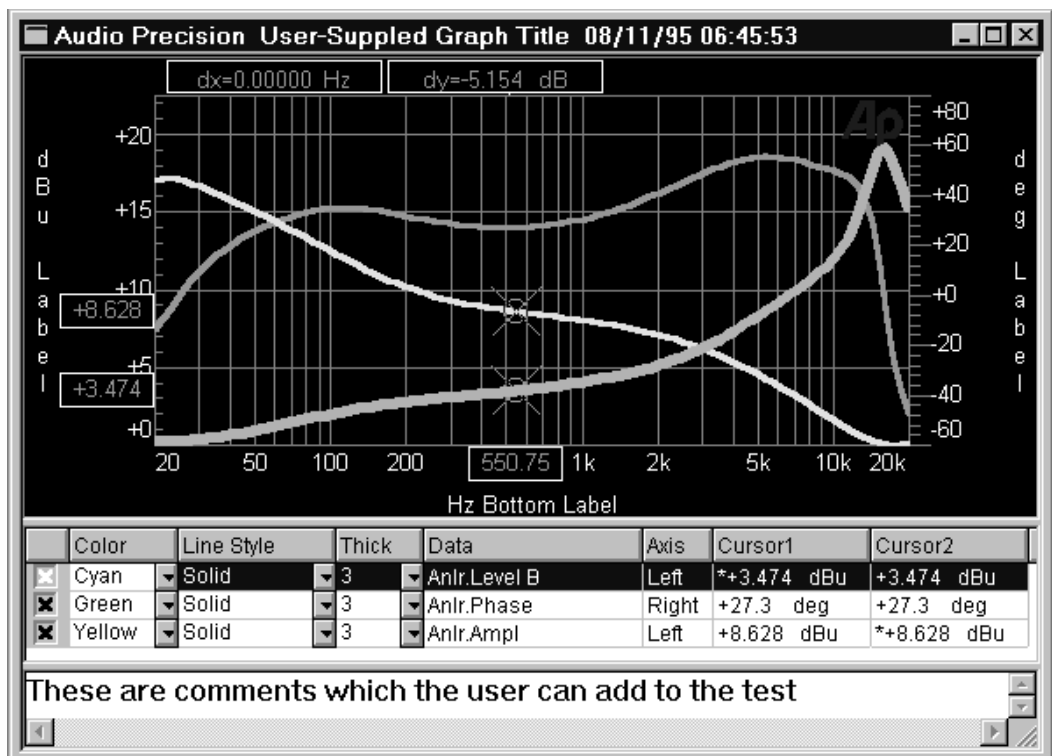

Figure 20-1 APWIN Graph Showing Cursors, Title and Labels, Legend, Comments

Two graph cursors may be dragged with the mouse or positioned by arrow keys to any points in the data for numeric display of data points and difference values. The cursors may both be attached to a single data trace, or each may be attached to a different trace if both traces are the same “domain” (both amplitude, for example).

The user may instruct APWIN to automatically choose X and Y coordinates for maximum resolution of the acquired data range (**Optimize**).

Scroll bars may be displayed to move up and down or back and forth on zoomed graphs.

A user-written title may be displayed at the graph top and labels may be placed in the top, bottom, left, and right margins of the graph.

An alphanumeric legend under the graph permits turning individual traces on and off, selecting trace colors, increasing trace thickness, changing line styles, explains which measured parameter is represented by each trace and which vertical axis calibration (right or left) is to be used, and provides simultaneous display of the value of all traces at the cursor positions.

A Comments editor box permits the user to freely type text which can be displayed on the screen and printed below the graph.

To bring the Graph to the screen:





Mouse: Click on the Graph icon  on the toolbar or select Panels Graph via the menu bar

Keyboard: Type    (for Panels gRaph).

## Zooming

You may zoom in on any area of the graph by clicking the left mouse button at one corner of the section to be magnified, then dragging (holding down the mouse button while moving the mouse) to the opposite corner of the section. A rectangular outline appears while dragging. When the mouse button is released, the graph re-draws to

expand the selected area. You may zoom repeatedly to magnify smaller and smaller areas.

When the graph is a frequency domain (spectrum analysis) or time domain (oscilloscope view) signal from one of the FFT programs, dragging a zoomed view also automatically sends the “Sweep Re-Process Data” () command to the DSP module so that the zoomed view will consist of the maximum possible resolution. Repeated zooms of an FFT spectrum analysis will eventually show the structure of the individual FFT bins. Zooming out also automatically sends the  command. This automatic  with zoom feature may be disabled in the Utilities Configure menu if it is not desired. Note that  can only be effective if the signal is still in DSP memory. A test loaded from disk, for example, will contain only the view of FFT results when the test was saved and increasing resolution during a zoom is not possible.

## Right Mouse Button Features

Clicking the right mouse button anywhere within the graph will display a selection of commands. The choices in the dialog box are: Zoomout, Zoom Out to Original, Optimize Individually, Optimize Together, Optimize Left Only, Optimize Right Only, Copy to Sweep Panel, Display Cursors, Scroll Bars, Title and Labels, and Comment.

### Zoomout

Clicking the normal (left) mouse button on the **Zoomout** choice in the dialog which appears when the right mouse button is clicked on a graph causes the most recent zoom view to be replaced with the previous one. If you have zoomed repeatedly, the coordinates of each zoom have been saved in sequence in a memory stack. You may then Zoomout repeatedly to work back up through the stack, viewing the series of zoomed views in reverse order.

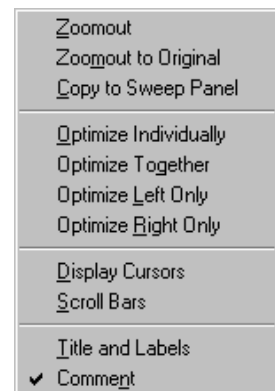







Figure 20-2 Mouse Right Button Dialog Box

When the graph is a frequency domain (spectrum analysis) or time domain (oscilloscope view) signal from one of the FFT programs, zooming in or out automatically sends the “Sweep Re-Process Data” () command to the DSP module so that the zoomed view will consist of the maximum possible resolution. Note that  can only be effective if the signal is still in DSP memory. A test loaded from disk, for example, will contain only the view of FFT results when the test was saved and zooming in or out with increased resolution is not possible. This automatic  with zoom feature may be disabled in the Utilities Configuration menu if it is not desired.

### Zoomout to Original

---

Clicking on this command in the dialog which appears when the right mouse button is clicked on a graph replaces the current zoomed-in view with the graph coordinates in use when the most recent sweep was started, or with the default initial graph coordinates if no sweep has yet been made since APWIN was launched.

When the graph is a frequency domain (spectrum analysis) or time domain (oscilloscope view) signal from one of the FFT programs, zooming in or out automatically sends the “Sweep Re-Process Data” () command to the DSP module so that the zoomed view will consist of the maximum possible resolution. Note that  can only be effective if the signal is still in DSP memory. A test loaded from disk, for example, will contain only the view of FFT results when the test was saved and zooming in or out with increased resolution is not possible. This automatic  with zoom feature may be disabled in the Utilities Configure menu if it is not desired.

### Optimize Features, General

---

Clicking the left mouse button on one of the **Optimize** commands in the dialog which appears when the right mouse button is clicked on a graph causes the graph to be automatically re-scaled with new top and bottom boundary lines for a maximum-resolution display of the actual range of data presently in memory. Optimizing after the conclusion of a sweep thus sets new coordinates to best display the entire data set. If an Optimize command is clicked while a sweep is in progress, the graph will optimally display the partial set of data

acquired up to that time, with new data taken in the remainder of the sweep then disappearing off the left or right of the graph. Optimize may be clicked as often as desired during a sweep or after manual changes in graph coordinates, but is most effective after the conclusion of a sweep. Four different forms of optimization are provided for better control of the results: Optimize Individually, Optimize Together, Optimize Left Only, and Optimize Right Only.

### **Optimize Individually**

The Optimize Individually command will be available only when both Data 1 and Data 2 are in use. Optimize Individually causes the Data 1 (left axis) graph top and bottom values to be automatically selected for best display of the actual values in the Data 1 data set, including any data in Data 3 through Data 6 which are mapping onto the Data 1 axis. Simultaneously, Optimize Individually selects new Data 2 (right axis) top and bottom settings for best display of the Data 2 data set and any Data 3 through Data 6 data which maps into Data 2. Even if both Data 1 and Data 2 axes are in the same units, the top, bottom, and number of divisions may not match following an Optimize Individually command, depending upon the actual data range in all the data sets which are calibrated against a particular axis.

### **Optimize Together**

The Optimize Together command will be available only when both Data 1 and Data 2 are in use. Optimize Together examines all the data in all data sets (Data 1 through Data 6) which map onto either the Data 1 (left) or Data 2 (right) axis, and then selects identical graph top and bottom values and division markings for both left and right axes which will show the entire range of data with maximum resolution and no data points plotting off the graph. Optimize Together thus preserves the ability to graphically compare traces plotted against both left and right Y axes.

### **Optimize Left Only**

The Optimize Left Only command is available whenever Data 1 is in use. It will optimize only the Data 1 (left) graph top, bottom, and number of divisions for best display of all data sets (Data 1 and



potentially Data 3 through Data 6) which are plotted against the left Y axis.

### Optimize Right Only

The Optimize Right Only command is available whenever Data 2 is in use. It will optimize only the Data 2 (right) graph top, bottom, and number of divisions for best display of all data sets (Data 2 and potentially Data 3 through Data 6) which are plotted against the right Y axis.

### Copy to Sweep Panel

---

Zooming and Optimizing cause the displayed graph coordinates (top, bottom, left, and right values) to be different from the values specified on the Sweep panel. Clicking on the **Copy to Sweep Panel** command in the dialog which appears when the right mouse button is clicked on a graph writes the values presently in use on the Graph into the Sweep Panel fields, replacing the user-entered values. This permits then making a new sweep or acquisition across the zoomed-in data range.



### Display Cursors

---

Clicking on the **Display Cursors** command in the dialog which appears when the right mouse button is clicked on a graph turns the graph cursor function of and off. The function is on when a check mark is displayed alongside Display Cursors in the dialog box.

Cursor function consists of two cursors and up to seven cursor value numeric display fields on the Graph. The cursors are named Cursor 1 and Cursor 2. Their initial appearance is as vertical green cursor bars extending from graph bottom to top, positioned near the edge from which the sweep started.

When a trace is selected (by clicking on the desired row in the legend below the graph), the thickness of the selected trace becomes greater and the vertical cursor is replaced by a large "X" at the point of intersection with the trace. An asterisk (\*) appears in the cells at the intersection of the Cursor columns and the selected trace row. Either cursor may be dragged to a new horizontal location with the mouse.

When the mouse cursor is positioned over a graph cursor or on the cursor value display box on the horizontal axis directly below the cursor, the mouse cursor changes from its normal arrow shape to  for cursor 1 and  for cursor 2. By holding down the left mouse button while the cursor has this shape and moving the mouse, the cursor may be dragged to any data point on the selected trace.

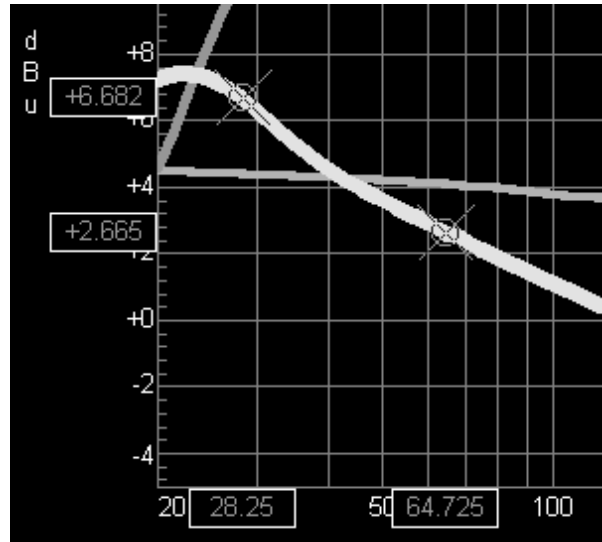



Figure 20-3 Cursors 1 and 2 Selected to Same Trace, Floating Numeric Readout Boxes in Line with Cursors. Cursor Positions May Be Dragged by Mouse on Display Boxes on Horizontal Axis

When the focus is on the graph, the selected cursor may also be moved with the horizontal arrow keys. The  with arrow key combination toggles arrow key control between Cursor 1 and Cursor 2. When a trace is selected, the cursor “snaps” from one data point to the next and cannot be positioned between data points.

The X and Y axis values at the intersection of each cursor with the selected trace are displayed in “floating” display boxes in the margins of the graph, aligned horizontally (Y value) and vertically (X value) with each cursor. The difference between the X values of the two cursors and the Y values of the two cursors are shown in display boxes at the top of the graph. If a “nested sweep” (via Source 2) has been plotted, the value of the Source 2 parameter of the selected trace is also shown at the top of the graph. The Cursor 1 and Cursor 2 columns in the Legend below the graph show the values of cursor intersection with all traces, whether selected or not. If the Data Editor is visible, the cursor position is indicated by a gray background in the particular cell.

The two cursors may be selected to two different traces. To do this, first select one of the two desired traces by clicking in its row in the legend under the graph. Asterisks (\*) will appear in the cells in both cursor columns at the intersection with the row which was clicked. Then, click in the column heading box (Cursor1 or Cursor2) of the cursor which you wish to move to another trace (Cursor2 in Figure 20-4). The column head will change to **\*\*Select\*\*** and the entire column will be displayed in inverse video. Click in the cell at the intersection of this column and the row of the trace to which the cursor is to be attached. The asterisk will now appear in that cell and the cursor will be attached to that data trace. Note that cursors may be attached to two different traces only if they display compatible parameters, since the “delta Y” display field would otherwise be meaningless. For example, the cursors may be attached to two traces displaying amplitude, but not to two traces if one displays amplitude and one displays phase.

Cursor1	<b>** Select **</b>
*+10.855 dBr	*+10.855 dBr
+6.612 dBr	+6.612 dBr

Figure 20-4 Legend Indication to Select Cursor to Second Trace

## Scroll Bars

Clicking on the **Scroll Bars** command in the dialog which appears when the right mouse button is clicked on a graph turns the check mark and Scroll Bars on and off. If the user has not zoomed in on the graph, scroll bars may be turned off for a larger graph. When zoomed, scroll bars permit looking at other portions of the data at the same magnification. The graph will scroll dynamically as the scroll button is dragged.

## Title and Labels

Clicking on the **Title and Labels** command in the dialog which appears when the right mouse button is clicked on a graph will display the Graph Title and Labels dialog box. The Title edit box at the top of this dialog box permits typing in any desired text which will then appear in the top margin of the graph, following the Company Name (usually Audio Precision) text and preceding the date and time text. The text will dynamically appear in the graph title bar on screen as it is typed. The title bar on screen is limited to displaying one line of text,

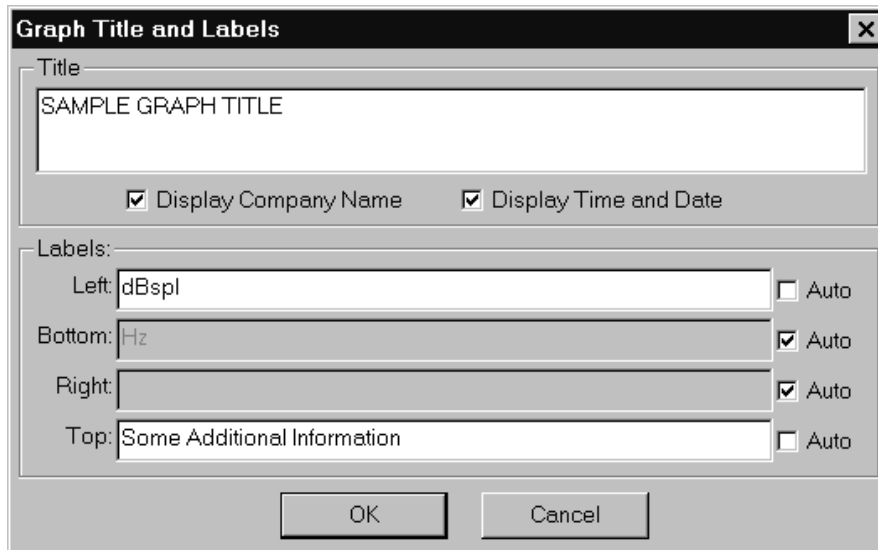

Figure 20-5 Title and Labels Dialog Box, Obtained by Clicking Right Mouse Button on Graph, Selecting Title and Labels

so the screen display of long titles will be truncated. However, the full title text typed in will display in Print Preview and will be part of a print-out. The “Audio Precision” text display at the left end of the title bar may be turned on and off by the “Display Company Name” check box. “Audio Precision” may be replaced by up to 32 characters of the user’s choice by use of the Utilities Configure menu command (see page 3-39). The date and time displayed at the right end of the title bar may be turned on and off by the “Display Time and Date” checkbox.

The left, bottom, and right labels normally are automatically supplied with the abbreviation for the measurement units graphed on each axis. This automatic label may be replaced or supplemented with additional text. To add custom text, un-check the “Auto” checkbox at the right end of the edit box to be changed. Then, you may delete or add to the text in the edit box. The top label has no automatic entry and may be used for any short text desired by the user.

### Comment

When the Comment line in the graph right mouse button dialog is checked, comments will be displayed below the graph. Comments may be typed directly into the Comment edit box, which is displayed

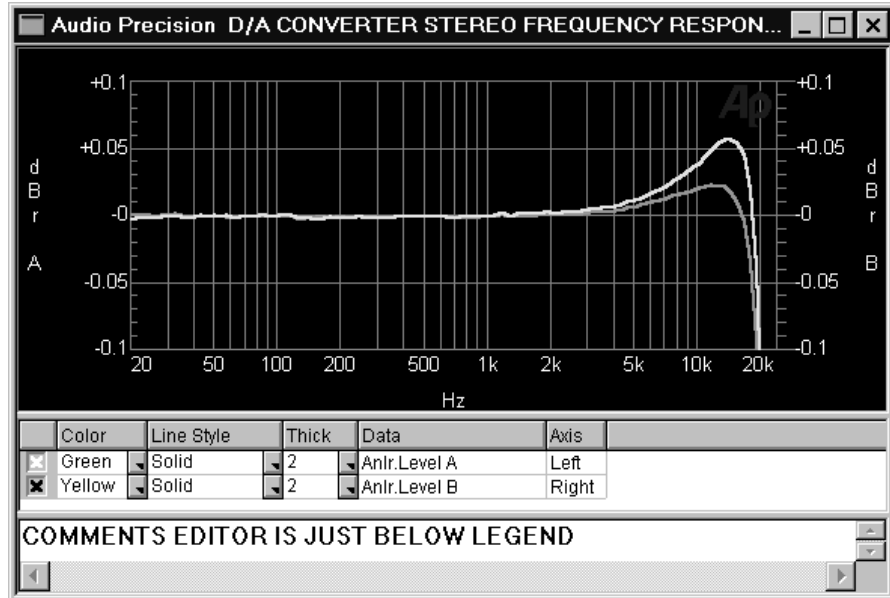



Figure 20-6 Comments Editor

under the Graph Legend as shown in Figure 20-6. The height of the Comment edit box may be adjusted by dragging the boundary line between the graph legend and the Comment edit box up or down. When the mouse cursor is positioned over the boundary, the cursor shape changes from its normal arrow shape to two closely-spaced horizontal parallel bars . With this cursor shape displayed, hold down the left mouse button and move the mouse vertically to drag the Comment edit box height to the desired value, then release the mouse button.

## Graph Legend

The alphanumeric tabular display area underneath the graph is called the Legend. The column heads are Color, Line Style, Thick, Data, Axis, Cursor1, and Cursor2. When Source 2 is used (to create a nested sweep), another column is added to show the Source 2 value of each trace. When limits are attached to a test and displayed on the graph, each limit trace will also have a row in the legend and the color, thickness, etc. of the limit traces may be changed. In addition to these

	Color	Line Style	Thick	Data	Axis	Source 2	Cursor1	Cursor2
<input checked="" type="checkbox"/>	Cyan	Solid	4	Anlr.Level A	Left	+20.000 dBu=Gen.Ampl	+23.181 dBV	+23.231 dBV
<input checked="" type="checkbox"/>	Green	Solid	4	Anlr.Phase	Right	+20.000 dBu=Gen.Ampl	+12.1 deg	-24.7 deg
<input checked="" type="checkbox"/>	Yellow	Solid	1	Anlr.BandPass	Left	+20.000 dBu=Gen.Ampl	*+23.062 dBV	*+23.227 dBV
<input checked="" type="checkbox"/>	Red	Solid	4	Anlr.Level A	Left	+10.000 dBu=Gen.Ampl	+13.177 dBV	+13.219 dBV
<input checked="" type="checkbox"/>	Magenta	Solid	4	Anlr.Phase	Right	+10.000 dBu=Gen.Ampl	+12.1 deg	-24.7 deg
<input checked="" type="checkbox"/>	Blue	Solid	1	Anlr.BandPass	Left	+10.000 dBu=Gen.Ampl	+13.051 dBV	+13.216 dBV

Figure 20-7 Graph Legend

columns, a check box at the beginning of each row permits displaying or not displaying each trace.

### Color (Screen Display)

The cells in the Color column show the color of each trace. The down arrow at the right of each cell displays a selection of seven different colors which may be selected to distinguish one trace from another.

Six colors (plus gray) are available for graph trace colors. There is a defined sequence of these six trace colors: cyan, green, yellow, red, magenta, and blue. This is the order in which the colors appear in the drop-down list in the Color column of the Graph Legend. Controls on the Utilities Configuration Graph tab provide control over how colors are

*Figure 20-8 Traces Automatically Change Through Color Sequence for Appended or Nested Sweeps*

assigned to traces on the graph.

## **Nested and Appended Sweeps**

---

When appended or nested sweeps are made, each trace cycles down through this color sequence, starting with whatever color the trace was on the previous sweep. An appended or nested sweep following a green trace thus always produces yellow, appending to a red trace always produces magenta, appending to a blue trace always goes “around the corner” to cyan, etc.

## **Reset Colors Cycle Checkbox**

---

If the “Reset colors cycle” box on the Graph tab of Utilities Configuration is checked and a normal sweep is made (not appended or nested), each trace color is directly associated with the Sweep panel Data parameter number that produces the trace. The color of the Data-1 trace is always cyan, the Data-2 trace is always green, Data-3 is always yellow, Data-4 is always red, Data-5 is always magenta, and Data-6 is always blue. If the user should manually change the color of any trace to another color following a sweep, then makes another sweep, the trace color will revert to the defined color per this paragraph. Appending and nesting sweeps will cause each trace color to cycle down through the sequence defined at the beginning of this section.

If the “Reset colors cycle” box is not checked, the user can manually change trace colors using the Legend and those user-selected colors will then be used for each successive normal (not appended or nested) sweep. These user-selected colors will also serve as the starting point for the automatic color cycling of appended or nested sweeps, with the cycling for any trace always being in the defined sequence described above. This mode of operation can allow three dual-trace sweeps or two triple-trace sweeps to be made with no duplication of colors. For example, a sweep is made using Data 1 and Data 2. The default colors assigned will be cyan for Data 1 and green for Data 2. If the “Reset colors cycle” box is not checked, the green Data 2 trace can be manually changed to red (the fourth color in the sequence). Now three sweeps can be made via Append or nested sweep. Colors for the first sweep will be cyan and red (1<sup>st</sup> and 4<sup>th</sup> colors), for the second sweep green and magenta (2<sup>nd</sup> and 5<sup>th</sup> colors), and for the third sweep

yellow and blue (3rd and 6th colors), as each trace progresses through the color sequence list.

### **Use Test Colors Only Checkbox**

---

If a test is loaded, the Append box checked, and additional sweeps are made (F9 or Go), the colors of the newly measured and appended traces depend on the “Use test colors only” box. If this box is checked, each newly appended set of traces will be the same color as the traces in the test that was loaded. If this box is not checked, the newly appended trace colors will cycle through the defined sequence, starting with the color of each trace in the test loaded.

### **Cycle Trace Colors Checkbox**

---

When the File Append command is used, the color of the appended traces depends on the status of the “Cycle trace colors” box. If this box is not checked, the trace colors of the appended file will come in exactly as they were in the file on disk being appended. If this box is checked, the colors of the traces appended from disk file will cycle through the defined sequence, using as the starting point the last set of traces currently in memory.

Colors assigned in the legend are retained through saving a test and subsequently opening the test and re-displaying the data with the  key. Note that colors for each trace in a hard copy print-out (assuming that a color printer is used) may be selected independently from the trace colors on the screen display by use of the File Page Setup command and dialog box.

### **Line Style (Screen Display)**

---

The Line Style column permits selecting solid lines or several combinations of dashes and dots to discriminate between traces. The selected line style will be displayed only when the trace thickness is one unit; thicker traces are always plotted with the Solid line style. If a line style is changed in the legend, new sweeps made after that time will plot with the new line style, for the current operating session of APWIN. Quitting from APWIN and re-starting will result in line style assignments for new tests going back to their original default values.



Line styles assigned in the legend are retained through saving a test and subsequently opening the test and re-displaying the data with the  key. Note that line styles for each trace in a hard copy print-out may be selected independently from the trace line styles on the screen display by use of the File Page Setup command and dialog box.

### Line Thickness (Screen Display)

---

The Thick column permits selecting the thickness of the displayed trace from 1 to 30 units. A scroll bar is provided to gain access to this full range of thickness values. The actual thickness obtained for a given selection depends upon the resolution of the computer screen, so some experimentation may be required to obtain the desired appearance. If a thickness value is changed in the legend, new sweeps made after that time will plot with the new thickness, for the current operating session of APWIN. Quitting from APWIN and re-starting will result in thickness assignments for new tests going back to their original default values.

Thickness values assigned in the legend are retained through saving a test and subsequently opening the test and re-displaying the data with the  key. Note that thickness values for each trace in a hard copy print-out may be selected independently from the trace thickness values on the screen display by use of the File Page Setup command and dialog box.

### Legend Data Column

---

The Data column lists the parameter (instrument and meter) plotted by that trace.

### Legend Axis Column

---

The Axis column tells whether the trace is calibrated by the left or right vertical axis and tic marks.

### Legend Source 2 Column

---

The Source 2 column, if displayed, shows which instrument setting or meter is being varied as Source 2 in a nested sweep, and what the value of that parameter is for each trace.

## Legend Cursor Columns

The two Cursor columns show the values on each trace at their intersections with the cursors.

## Trace Selection

The “selected” trace, which is displayed on the graph with greater trace thickness than the other traces, is the trace which the cursors will be attached to and whose values at the cursor positions will be displayed in the “floating” numeric display boxes at the margins of the graph. The selected trace is indicated in the Legend by an inverse video highlight. A different trace may be selected by clicking on its row in the Legend or using the vertical arrow keys. To de-select a trace, click again on the Legend row presently selected. If limit traces are displayed, it is not possible to select them.

## Rows, Legend Size, Column Width

When there are more traces on the graph than can be displayed in the Legend at its present size, vertical scroll bars appear so that all rows in the Legend may be examined and selected. As traces are added due to appended sweeps or successive progressions through a nested sweep, the newest trace information appears at the bottom of the Legend and older data is pushed up.

The proportion of the total Graph window occupied by the Legend may be adjusted by dragging the boundary line between legend and graph or legend and Comments

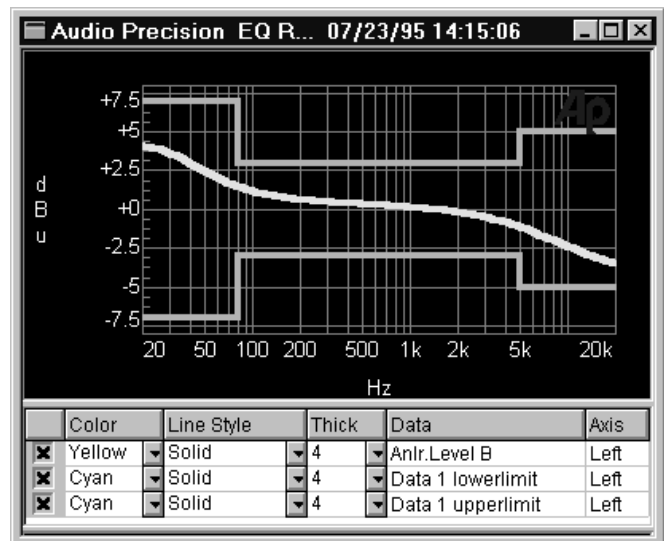



Figure 20-9 Graph and Legend Showing Data Trace and Upper and Lower Limits

Editor up or down. When the mouse cursor is positioned over the boundary, the cursor shape changes from its normal arrow shape to two closely-spaced horizontal parallel bars . With this cursor shape displayed, hold down the left mouse button and move the mouse vertically to drag the Legend height to the desired value, then release the mouse button.

Individual column widths in the Legend may also be changed by positioning the mouse cursor over any column boundary until it changes from its normal arrow shape to two closely-spaced vertical parallel bars . Hold the left mouse button down and drag the column width to the desired value. All columns to the right will maintain their previous size, so it is best to work from left to right when planning to re-size several columns.

See the Sweep panel discussion for information on how to assign parameters to traces, set the graph top and bottom values and number of divisions and tic marks, etc.

### **Graph Legend and Data Editor Interaction**

---

“Interconnection” features make it easy to identify which data in the Data Editor corresponds to which trace on the graph when there are multiple traces resulting from nested sweeps or the File Append command.

In the Graph Legend, the first, third, fifth, etc. nested or appended sweeps are indicated by bold type and a gray background. The Legend descriptions of the second, fourth, sixth, etc. sweeps are shown with normal type and a white background.

In the Data Editor, bold type corresponds to bold rows in the Graph Legend and normal type to normal rows. Furthermore, clicking in any row in the Graph Legend causes the Data Editor to automatically scroll vertically such that the first row displayed in the Data Editor is the first point of the sweep data just clicked in the Graph Legend.

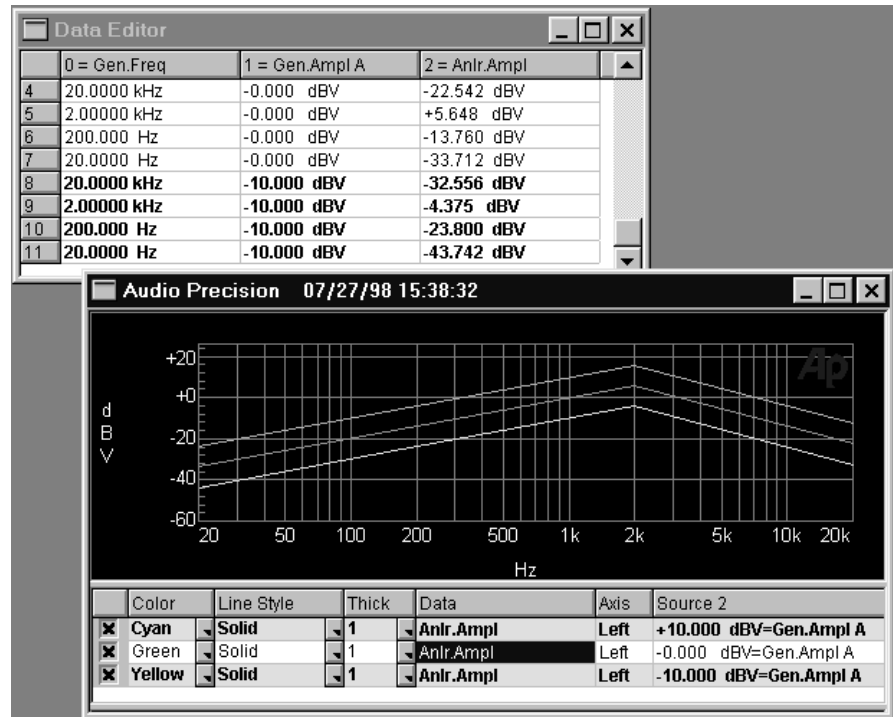



Figure 20-10 Graph Legend and Data Editor, Showing Bold/Normal Type and Gray/White Background “Connections”

## Keyboard Control of Graph

Zooming by dragging intrinsically requires the use of a mouse. Nearly all other graph-related features are available from keyboard alternatives. For all of the control methods described in this section to function, the Windows focus must be on the Graph window as indicated by the graph title bar being blue rather than gray. If the focus is not on the graph, use the **CTRL** **TAB** keystroke to move the focus to the graph.

To select among the graph itself, the graph legend, and the comments editor, use the Tab key. When the graph legend is selected, the top left box (left of “Color” and above the “X” column to turn traces on and off) will be blue. When the Comments editor is selected, a blinking text cursor appears in the editor. If neither of these is true, the graph itself is selected.

## Keyboard Access to “Right Button” Features

When the graph itself is selected, the  keystrokes will cause the same dialog to display which is also accessed by the mouse right button. The up and down arrow keys then move an inverse video selection bar among the rows. Pressing the  key makes the selection and causes the dialog to disappear.

If cursors are displayed and “attached” by selecting a trace (see Legend section below), the horizontal arrow keys move the selected cursor from point to point. To shift keyboard control between Cursor 1 and Cursor 2, press the Shift key while pressing either horizontal arrow key once.

When the Title and Labels dialog is selected, the  or  keys move among the various fields.

## Keyboard Control of Legend

When the graph legend is selected, the horizontal arrow keys move the selection through the columns of the legend. The vertical arrow keys move the selection up and down through the legend row. When the first column is selected, the Space bar toggles between displaying or hiding the selected trace (row). When the Color, Line Style, or Thickness columns are selected, the Alt Down Arrow keystrokes cause the list of selections to be displayed. The Up Arrow and Down Arrow keys then move the selection up and down the list, and the Enter key makes the selection.

## Bar Graphs

A new Bar Graph can be created on the screen by:

clicking on the Bar Graph icon  on the toolbar

or

selecting Panels Bar Graphs from the menu bar

or

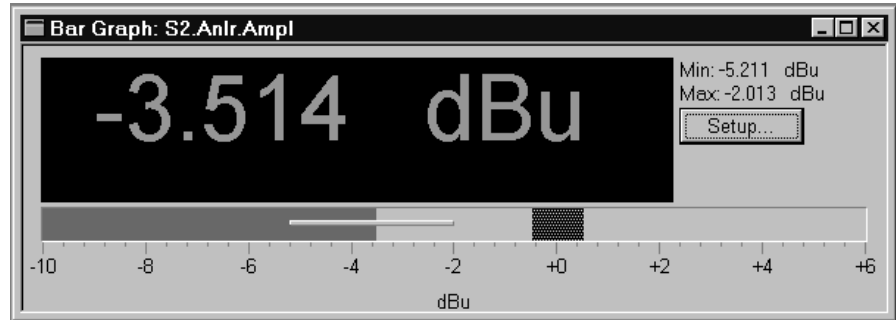

Figure 20-11 Readings Bargraph, Showing Max-min Bar and Target Area

from the keyboard, pressing **ALT** **P** **B** (Panels Bar Graphs)

By default, each newly-created bar graph will display the measurement from the last panel meter field clicked with the mouse before the Bargraph icon was clicked. If no meter has been clicked, the Analog Analyzer Function Reading meter measurement will be displayed. To change to any other measurement or setting, click the Setup button on the bargraph (not visible if the bargraph has been dragged to a small size), or click the right mouse button anywhere on the bar graph.

A Bargraph Setup dialog box will appear. A “browser” control permits selection of a chassis, an instrument, and a reading or setting parameter of that instrument. Units to be displayed are chosen by clicking on the down arrow of either the “Left” or “Right” field, then selecting the desired unit. The values for bargraph end points are then

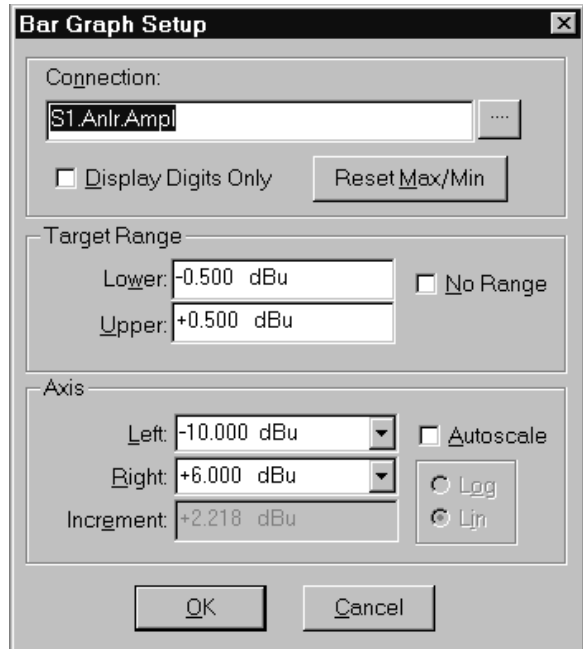





Figure 20-12 Bargraph Setup Dialog, Obtained by Mouse Click on Setup Button or Right Click on Bargraph

free-form numeric entries into the Left and Right fields. Press  or the  (or  ) keys to complete the entry. Log calibration may be selected if both end values are positive numbers.

A bargraph may be set to any size desired by dragging any of the corners or edges. The size of the digital display scales with the size of the bargraph.

## Readings Bargraphs

---

The present value of the parameter measured is displayed by a magenta graph. The Autoscale box may be checked to cause the bargraph end points to automatically be set to values sufficient to keep the largest measured data values on the graph.

### Readings Max/Min

A thin gray stripe in the center of the magenta area shows the minimum and maximum values which have been reached by the parameter since the bargraph was created or reset. The min/max feature may be reset by pressing the  function key when the Windows focus is on the bargraph (title bar is blue) or by clicking the right mouse button on the bargraph, then clicking Reset Max-Min, followed by clicking OK.

### Readings Target Range

The Target Range feature of a bargraph may be used to mark a range as acceptable or to set a target value or range for operator manual adjustments. Note that this visual Target range on a bargraph has nothing to do with Acceptance Limits and Pass/Fail testing during a sweep. To enable the Target feature, un-check the “No Range” checkbox on the Bargraph Setup dialog box which appears when the right mouse button is clicked on a bargraph. Then, enter the desired upper and lower values for the Target Range and click OK.

## Settings Bargraphs

---

A settings bargraph is created by selecting a setting rather than reading in the Bargraph Setup dialog box. End points, units, and

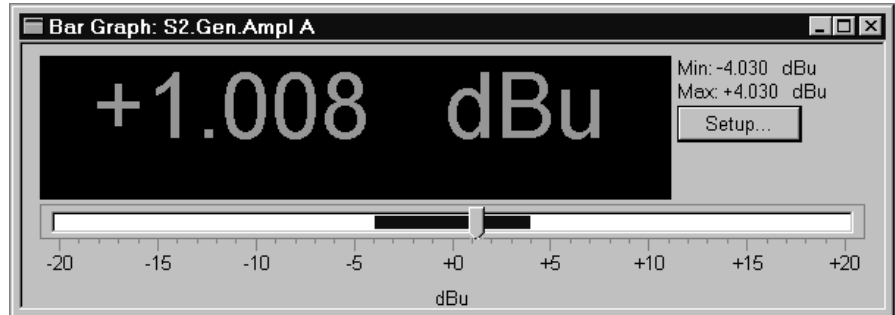

Figure 20-13 Settings Bargraph Showing Max-Min Range

log/lin (if neither end has a zero or negative value) may be selected exactly as in a Readings bargraph.

The Increment field of a Settings bargraph permits selection of the increment size in which a parameter will be varied when the slider on the settings bar graph is dragged the minimal distance or when the left or right arrow keys on the keyboard are pressed. Clicking in the “slider track” to the right or left of the slider control will cause the setting to increase or decrease, respectively, in larger steps. A dark blue coloring of the “slider track” shows the minimum and maximum values to which the parameter has been set.

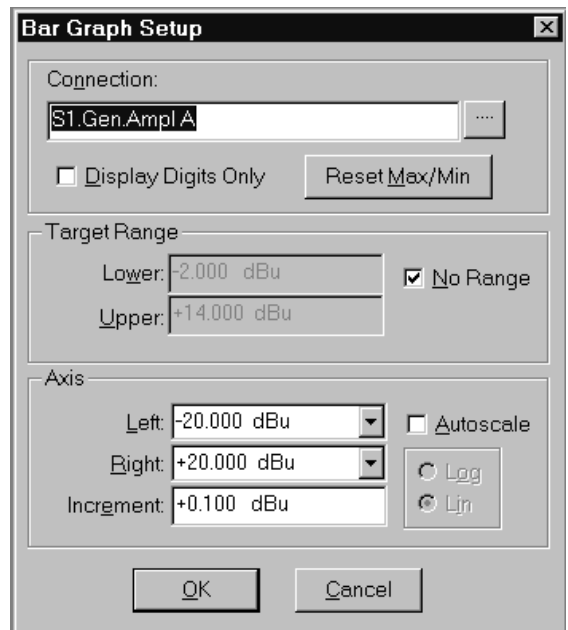
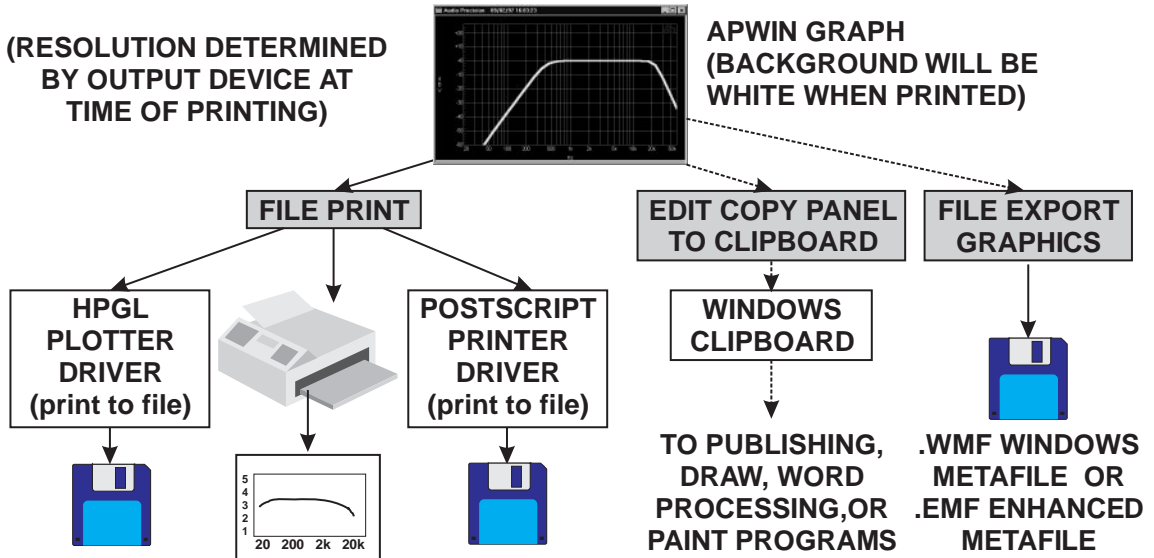

Figure 20-14 Bargraph Setup Dialog Box for a Setting Bargraph



## VECTOR GRAPHICS



## BITMAP GRAPHICS

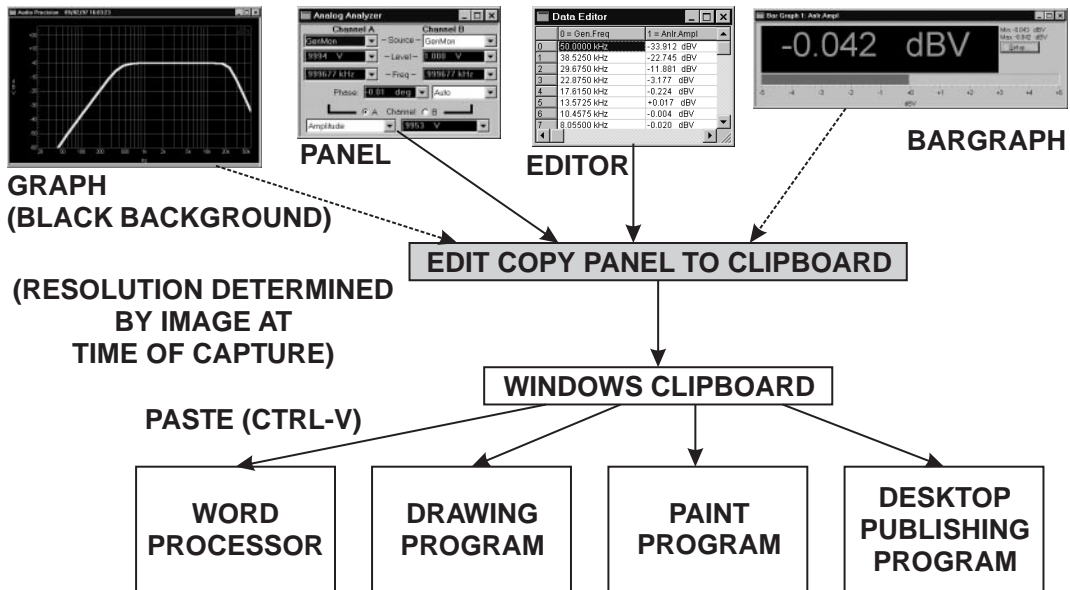

Figure 20-15 Schematic Representation of Various Hardcopy Techniques

## Printing

Several different techniques are available for making paper copies of APWIN graphs and, in some cases, other panels. Each has a different set of advantages and disadvantages. A tabular listing of measured data can also be printed. The methods are:

- **File Print Graph.** Prints the current graph in vector format to an attached Windows-compatible printer. Resolution of a vector file is dependent only on the eventual output device, not on the graphics resolution of the computer. This technique is fast and flexible, supporting any printer (monochrome or color) which is installed to Windows. Only graphs may be printed by this method, not bargraphs, instrument panels, etc. Graphs may also be “printed” to an HPGL or Postscript file by this technique, with the file then loaded into another program for editing or printing
- **File Print Data.** Prints the entire contents of the data editor, as tabular text, to an attached Windows-compatible printer.
- **Edit Copy Panel to Clipboard.** Copies any selected APWIN window (graph, bargraph, instrument panel, dialog, etc.) in bitmap format to the Windows clipboard; or, optionally, copies only the graph to the clipboard in metafile (vector) format. The selection between black-background bitmap or white-background metafile format is made on the Graph tab of the Utilities Configuration dialog of the menu. The clipboard contents may then be pasted into another Windows application for editing or printing. The parameters of the metafile format on the clipboard (trace color, which text elements also print, etc.) are controlled by the File Page Setup dialog.
- **File Export Graphics.** Creates a Windows Metafile (.wmf) or Enhanced Metafile (.emf) copy of the graph as a disk file. This file may then be loaded into another Windows application for editing or printing. A metafile is a vector format whose resolution is dependent only on the eventual output device, not on the graphics resolution of the computer.

- **Print Screen.** The stand Print Screen key on the computer keyboard makes a bitmap copy of the entire screen to the Windows clipboard. From there, the bitmap may be pasted into many other Windows applications for printing or editing.

The remainder of this chapter provides details on the the File Print method. The Edit Copy Panel to Clipboard and File Export Graphics methods are described in more detail in the Menus chapter.

## File Print

---

Graphs or a tabular listing of measurement data may be printed via the File Print command. Selecting File Print will display subsidiary selections of Graph and Data.

### Tabular Data Listing

The File Print Data selection will create a text listing, in columns, of the contents of the data editor. The listing may consist of up to eight columns—Source 1, Source 2 (if a nested sweep), and Data 1 through Data 6.

### File Print Graph

APWIN graphs may be printed to color or monochrome printers or to an HPGL or Postscript file. The appearance of the graph may be previewed by the File Print Preview command before actually making the print-out. The print-out may be set up by the user to have different line styles or trace widths and different colors from the graph displayed on screen, and the various text elements such as comments, title, legend, and labels may be included or excluded from a print-out independently from their use on screen. These selections are made in the File Page Setup dialog. File Print Setup allows the user to change between different printers.



To print a graph:

select the File Print command under the File Menu

or

click on the Print icon 

or

from the keyboard, press the   key combination

or



from the key board, press     (for File Print Graph).

Clicking on the Print icon causes an immediate print-out according to the present settings of the Page Setup screen, without giving the user the opportunity to make changes. The File Print command (and its keyboard alternatives) displays the standard Windows Print dialog box. This dialog permits selection of the number of copies and shows which printer will be used. The Properties button gives access to additional features including Landscape versus Portrait orientation of the graph on the page (which will be overridden if the Portrait/Landscape selection is changed on the Page Setup screen), and the paper tray to be used on multiple-tray printers..

When all selections are made, click on the OK button or press the Enter key. A message will be displayed while APWIN sends the data to Windows and the printer.

## File Print Setup

---

The File Print Setup command permits selection of the printer to be used (or of an HPGL or Postscript driver installed for purposes to “printing” to an HPGL or Postscript file; see the Printing to File section on page 20-34. Print Setup also controls the paper orientation (landscape versus portrait) and the paper size and source on printers that have multiple paper trays. To display the Print Setup dialog box, select Print Setup under the File menu or press the    keys (for File pRint setup).

## File Page Setup

---

The File Page Setup dialog (see Figures 20-16, 20-17, and 20-18) permits flexible control of the size, margins, line styles, colors, grid line appearance, and various modules of text information on graph

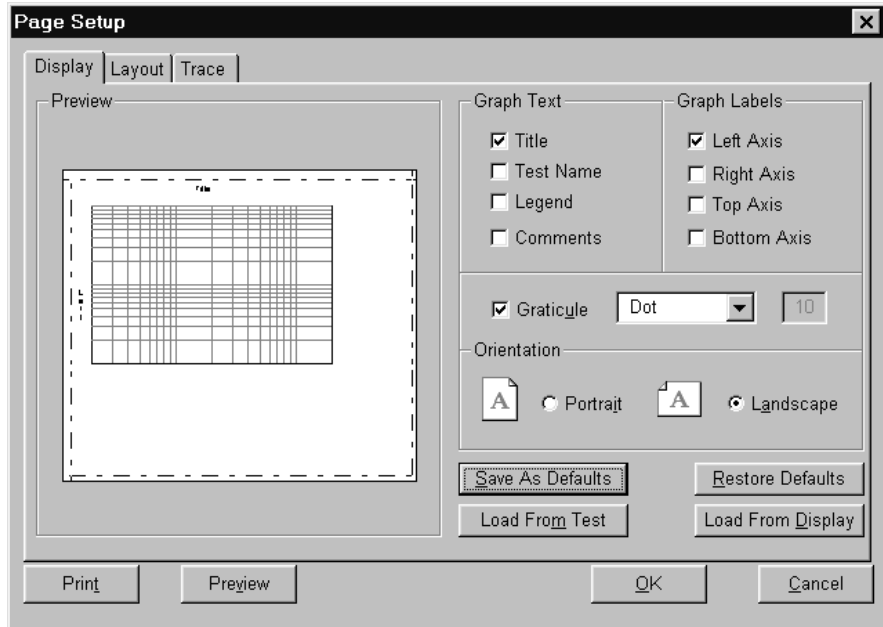

Figure 20-16 Page Setup Dialog, Display Tab

print-outs. The settings in the Page Setup dialog can track the on-screen graph settings, or they can be independent of those in the Graph Legend, permitting one scheme to be used for screen display and another scheme for paper print-out. Achieving the desired appearance of a graph print-out often involves an iterative process of viewing the preview results, making changes to the Page Setup dialog, and viewing the results again. Thus it is often desirable to start preparation of a graph for printing by selecting Page Setup since you can then jump directly to the Print Preview screen by clicking on the Preview button on the Page Setup screen and can jump back from Print Preview to Page Setup by pressing the Esc key on the keyboard. The actual printing of a hard copy may be initiated by clicking on the Print key of either the Print Preview screen or the Page Setup screen.

To display the Page Setup dialog, click on the Page Setup command under the File menu. This dialog is organized into three tabs—Display, Layout, and Trace.

## Landscape vs. Portrait

The Display tab of the Page Setup dialog window shows a graphic representation of the page in the selected Landscape or Portrait mode, with the size of the graph and its location on the page also represented. The selection between Landscape or Portrait is made by clicking on the appropriate button at the right center of the window.

## Displaying Text Elements

The Display tab of the File Page Setup dialog controls whether eight specific text elements are printed or not. The individually controllable parts are the Left Axis/Label, Bottom Axis/Label, Right Axis/Label, and Top Axis/Label (all in the Graph Labels section), Title, Test Name, Legend, and Comments in the Graph Text section. The Legend consists of the information displayed below the screen graph, showing which color and line style or thickness trace plots each data parameter and which vertical axis is the calibration reference for the trace. Comments is a free-form text editor and display for additional information of any type. The Test Name selection causes the name of the test file to be printed at the bottom of the graph, below the bottom axis/label. Left Axis/Label refers to the left-hand Y-axis calibration (Data-1) and any additional label information that may have been added by the user. Bottom Axis/Label is the X-axis (usually Source 1) calibration and optional added label. Right Axis/Label is the right-hand Y-axis (Data-2) calibration and optional label. The Top Axis/Label is purely optional for user-added information. The Title appears in the blue Title Bar at the top of the screen-displayed graph and at the top left of a printed graph. Optional data is entered into any of these last five areas via the Title and Labels choice of the right mouse button menu obtained by clicking on the screen display of the graph.

## Graticule Appearance

The Display tab carries the controls that permit turning the graticule (vertical and horizontal grid lines on the graph) on and off via its checkbox. Furthermore, the grid lines may be selected as any of five standard and one custom line styles. Clicking the down arrow at the right end of the field to the right of the Graticule check box displays a

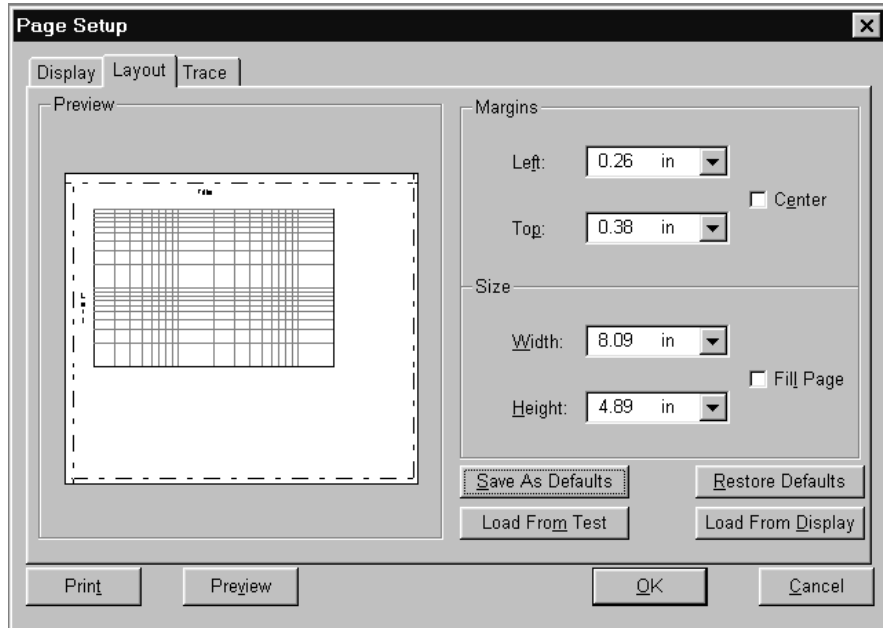

Figure 20-17 Page Setup Dialog, Layout Tab





list of dot and dash line styles to be used for the grid lines. The last selection, “Dots per inch”, operates in conjunction with the numeric entry field to its right to permit the user to specify the dot density of the printout.

## Graph Margins and Size

The margins and size of the graph may be set by entering numbers in the Left, Top, Width, and Height boxes on the Layout tab of the Page Setup dialog. Units may be selected as inches or millimeters by clicking on the down arrow at the right of any of these boxes, with the units for all four fields then changing simultaneously.

Check boxes to the right of the margin and size fields permit automatically centering the graph on the page (Center checkbox) or maximizing the size of the graph on the page (Fill Page checkbox).

The graph may also be stretched or compressed in size and dragged to another location on the page by use of the mouse. When the mouse cursor is positioned over the top or bottom margin of the representation of the graph, the cursor shape changes to a vertical

two-headed arrow  and the graph may be stretched or compressed vertically by holding down the left mouse button while moving the mouse (dragging). When the cursor is placed over either the left or right margin, the cursor shape changes to a horizontal two-headed arrow  and the graph may be stretched or compressed horizontally. When the cursor is placed at any of the four corners of the graph, the cursor shape changes to a diagonal two-headed arrow  whose direction depends on the  corner selected, and both height and width can be changed simultaneously by dragging with the mouse. None of these actions can be taken if the Fill Page checkbox has been checked.

The graph may be dragged to another location on the page with the mouse. With the cursor anywhere over the central portion of the graph, the mouse cursor shape changes to an X shape with arrowheads . Holding down the left mouse button while moving the mouse will then drag the graph, at its present size, to a new location. The graph location cannot be changed if either the Center or

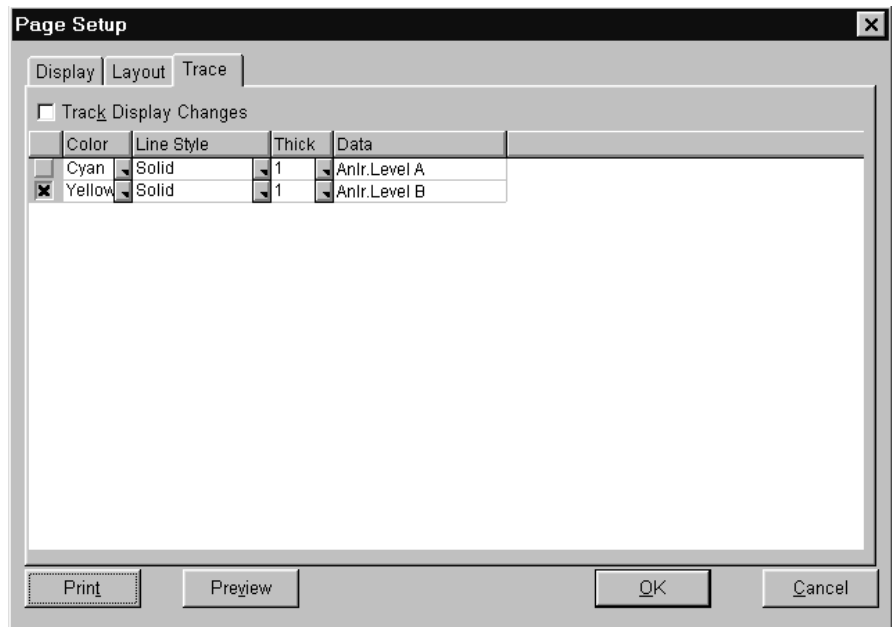

Figure 20-18 Page Setup Dialog, Trace Tab



Fill Page checkboxes have been checked.

## Trace Appearance

The Trace tab provides control over which data traces are to be printed. It also permits selection of the Color (if a color printer has been selected via the Print Setup menu command), Line Style (solid, dash, dot etc.), and trace Thickness of each. All of these settings are independent from the settings of the same parameters for the computer screen display, as controlled in the Graph Legend. Thus, the screen display can be set for trace colors while the print-out on a monochrome laser or dot matrix printer can use various dash and dot line styles to distinguish between different graphed parameters.

Trace color and line style or width selections may be made individually for a large number of traces such as can result from appended or nested sweeps. If those settings are saved as defaults and a later test made which only uses one or a few traces, the colors and styles will be assigned from the saved defaults in sequence. For example, assume a six-trace page setup is made with the colors in the sequence (top to bottom in the legend on the Page Setup dialog) blue, red, yellow, magenta, green, and cyan. Assume the “Save As Defaults” button is clicked. If another test is now set up or loaded from disk that uses only two traces, the printed colors of those two traces would be blue and red (but could be changed if desired). If still another test is loaded or set up with five traces, the colors automatically assigned would be blue, red, yellow, magenta, and green.

The “X” box at the left end of each row controls whether that trace will be printed.

Clicking the down arrow at the right end of the Color field causes a list of available colors to be displayed, and the desired color can be selected. Note that the Gray color selection may result in a black trace on color printers, since gray does not print reliably on all color printers.

Clicking the down arrow at the right of the Line Style box displays a list of available line styles (solid, dash, dot, etc.) which are particularly useful with monochrome printers to distinguish between

traces. Note that line styles other than solid will only print at a trace Thickness of one unit; thicker traces are always printed as a solid style.

Clicking the down arrow at the right of the Thickness cell produces a list of available line widths from 1 to 30 units. The vertical scroll bar in this box must be used to gain access to all values. The actual trace thickness on the final printed page will depend on the resolution of the particular printer, so some experimentation may be required to obtain the desired result. As noted above, Thickness values greater than one will print as a solid trace even if some other line style has been selected.

Particularly on lower resolution displays, the width of the Page Setup box may not be sufficient to display the full width of the Data, Color, Line Style, and Thickness columns including the down arrows at the end of the Thickness column. In this case, the mouse cursor can be used at the ends of the column heading cells to drag the columns to a narrower width.

### **Independence of Printed from Screen Graph**

Certain aspects of the printed graph (including which parameters are graphed, graph top and bottom and left and right calibrations, etc.) depend totally on the screen display and cannot be changed from the Page Setup dialog. Other aspects (including trace color, line style or thickness, and whether or not each text element is displayed/printed) can be set independently on the Page Setup dialog from the screen display, if the "Track Graph Changes" checkbox at the top of the Trace tab is not checked. Preferred settings for print-out may be saved as defaults to the APWIN.INI file so that they become the user's standard settings. These standard defaults may then optionally be overridden with either the current Graph Legend settings or with the settings stored to disk as part of a test file and re-loaded. If the "Track Graph Changes" box is checked, the color, line style, thickness, etc. controls disappear from Page Setup and the Graph Legend settings are used for printing.

### **Save As Defaults**

Clicking the "Save As Defaults" button on the Display or Layout tabs causes all current settings of the Page Setup dialog to be written

into the APWIN.INI file. These become the Page Setup dialog settings each time APWIN is started, and may replace any current settings at the user's option by clicking the "Restore Defaults" button.

### Restore Defaults

Clicking the "Restore Defaults" button on the Display or Layout tabs replaces all current settings of the Page Setup dialog with the settings from the APWIN.INI file. These would be the settings in use the last time the "Save As Defaults" button was clicked.

### Load From Test

All information from the Page Setup dialog is saved to disk along with all instrument panel settings, test data, etc., in a test file. If the user wishes to print with the Page Setup settings which were in use when a test file was saved, rather than the current defaults from the APWIN.INI file, click the "Load From Test" button on the Display or Layout tabs.

### Load From Graph

Many parameters may be set independently for the screen display of graphs and paper print-out controlled by Page Setup. These parameters include the trace color, line style or thickness, and whether or not each trace is displayed. If the user wishes to replace the current settings of the Page Setup dialog box with the current Graph settings, click on the "Load From Display" button on the Display or Layout tabs.

### File Print Preview

---

To see the results of a graph print-out before actually printing, click the Print Preview icon  , select the Print Preview command in the File menu, or from the Page Setup dialog of the File menu, press the Preview button.

If there is a graph on screen, Print Preview displays on the computer screen the page very much as it will appear; see Figure 20-19. The Zoom In and Zoom Out buttons at the top of the screen may be used to look at portions of the page in more detail. When the

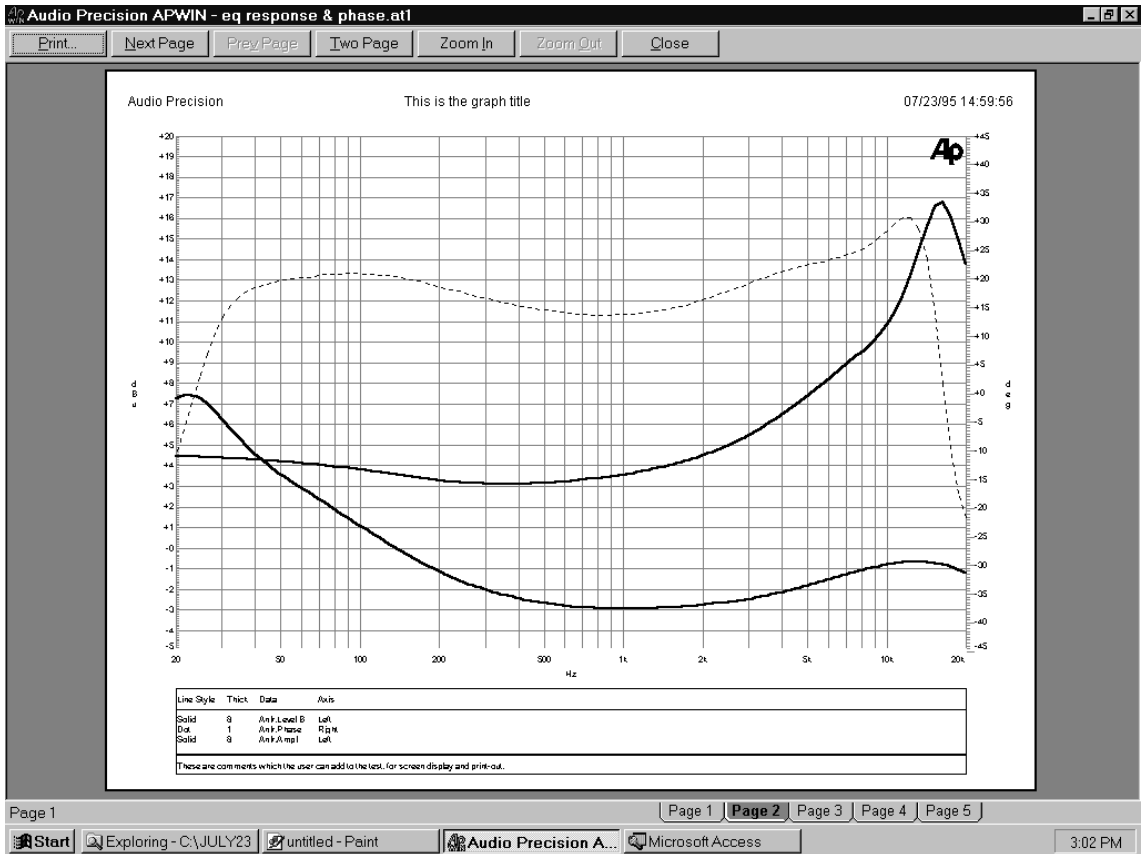

Figure 20-19 Print Preview Screen

mouse cursor is positioned over the graph area, the cursor takes on the shape of a magnifying glass; in this condition, clicking the left mouse button once has the same effect as clicking the Zoom In button once. A third click of the left mouse button, when the preview graph has been zoomed to the maximum magnification, returns the view to the original view.

Achieving the desired appearance of a graph print-out often involves an iterative process of viewing the preview results, making changes to the Page Setup dialog, and viewing the results again. Thus it is often desirable to first select Page Setup, since you can then jump directly to the Print Preview screen by clicking on the Preview button on the Page Setup screen and can jump back from Print Preview to Page Setup by pressing the Esc key on the keyboard. The actual

printing of a hard copy may be initiated by clicking on the Print key of either the Print Preview screen or the Page Setup screen.

## Printing to a File

---

APWIN and Windows can print a graph to an HPGL or Postscript disk file. Many types of word processing, graphics, and desktop publishing software will import HPGL and Postscript files.

To print a graph to a file, first use the printer installation feature of the Settings Printers command from the Start button to install a driver for an HPGL plotter or a Postscript printer, as desired. In the “Connections” dialog of the installation, select “File” rather than a real-time output port such as LPT1 or COM2. With this printer selected under APWIN’s Print Setup command, a disk file will result from the APWIN Print command or icon.

Note that an alternative method exists for bringing graphs (and bargraphs, panels, etc.) into other Windows applications. Selecting the desired APWIN panel or graph followed by use of the Edit Copy Panel to Clipboard menu command will copy the selected graph or panel to the Windows clipboard. It may then be pasted into another Windows program such as a word processor or desktop publishing program by use of the Paste () command.

# Limits, Data Editor, and Attached File Editor

---

Limits are the extreme values of a performance parameter which are considered by the responsible persons to be acceptable. Acceptance test limits (often also referred to as Pass/Fail limits or Go/No Go limits) are commonly used in quality assurance, manufacturing production test, incoming inspection, and routine maintenance applications.

In APWIN, one or more limit data files (.ADL files) contain the numerical values to be used as limits. These files are commonly created in the APWIN Data Editor and later edited, if necessary, in the Attached File Editor. A single .ADL file may contain both upper and lower limits if desired, and may contain limits for several different parameters if desired. Alternately, a separate .ADL file could be used for each limit. The Limits buttons on the Sweep panel are used to establish cross-reference instructions on which .ADL file (and which column of data within the file) is to be used for each measured parameter in a sweep test, and to gain access (via the Edit button) to the Attached File Editor.

When a test is run with limits attached, several courses of action can be taken if a measurement falls outside limits. The test may be made to halt at the first out-of-limits condition. Results may log into a log file. Failure indications will appear in a tabular listing (Data Editor). If the test is running under control of an APWIN Procedure, the full flexibility of the Basic programming language can be used on failure.

## Using Data Editor

---

The Data Editor is used to create .ADL files for use as Limit data files for Pass/Fail testing, or .ADS files for use as Sweep Tables with the Table Sweep feature. To open the Data Editor:

click on the Data Editor icon 

or

select Panels Data Editor

or

from the keyboard press

   (for Panels data editOr).

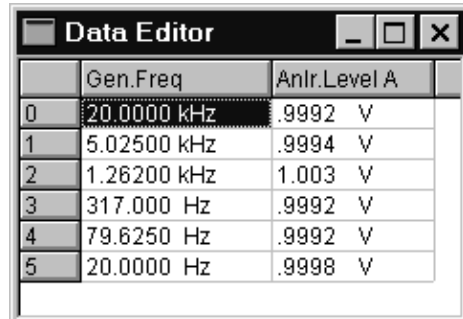

	Gen.Freq	Anlr.Level A
0	20.0000 kHz	.9992 V
1	5.02500 kHz	.9994 V
2	1.26200 kHz	1.003 V
3	317.000 Hz	.9992 V
4	79.6250 Hz	.9992 V
5	20.0000 Hz	.9998 V

Figure 21-1 Data Editor

The mouse can be used to drag any edge or corner of the Data Editor to bring it to any desired size. The Data Editor can be toggled between a full screen size and the user-dragged size by double-clicking in the title bar, clicking on the “large/small version” icon or using the

  or   keys. The “large/small version” icon is .

If there is presently data (from a sweep) in memory, you will see a tabular listing of the data. The first column shows the Source 1 values and the remaining columns (if the test was not a nested sweep) the Data 1 through Data 6 values. If the test was a nested sweep, the second column displays the Source 2 values and the remaining columns the Data 1 through Data 6 values. If the graph cursors are displayed and a trace selected in the Graph Legend, the cursor location appears in the Data Editor as a cell with a gray background.

## Legend—Data Editor Interaction

Several features make it easy to identify which data corresponds to which trace when there are multiple traces resulting from nested sweeps or the File Append command.

In the Graph Legend, the first, third, fifth, etc. nested or appended sweeps are indicated by bold type and a gray background. The Legend descriptions of the second, fourth, sixth, etc. sweeps are shown with normal type and a white background.

In the Data Editor, bold type corresponds to bold rows in the Graph Legend and normal type to normal rows. Furthermore, clicking

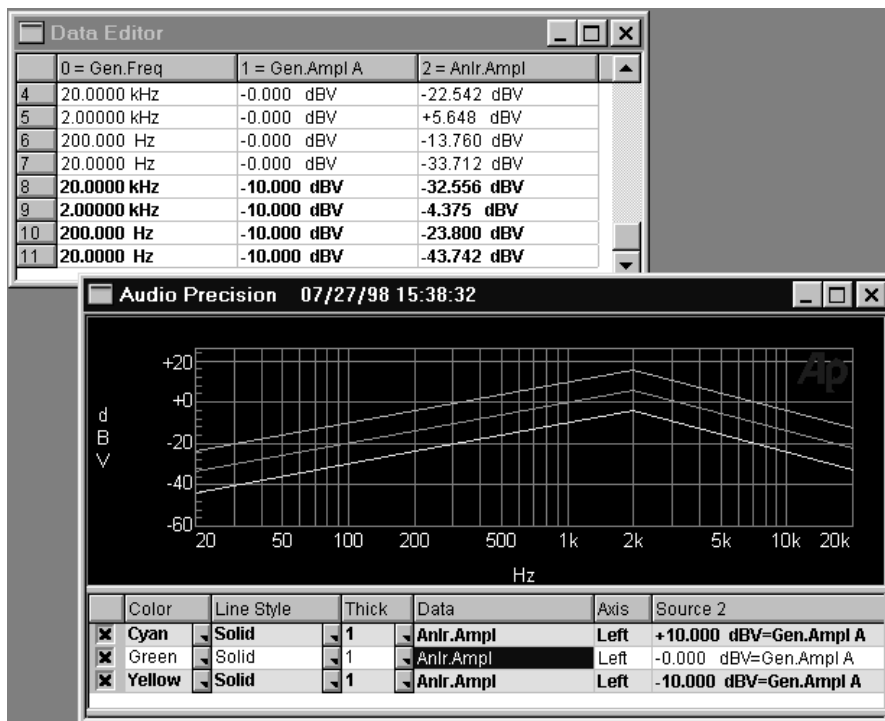

Figure 21-2 Graph Legend and Data Editor, Showing Bold/Normal Type Correlation Between Sweeps

in any row in the Graph Legend causes the Data Editor to automatically scroll vertically such that the first row displayed in the Data Editor is the first point of the sweep data just clicked in the Graph Legend.

### Selecting Rows

Individual data rows or groups of rows may be selected for deletion or inserting new rows. To select an individual row, click the button at the left end of the desired row or hold down the Shift key while clicking anywhere in the row. Multiple rows may be selected by individually clicking the button at the left of each desired row, or clicking and dragging down across a range of buttons, or holding down the Shift key while dragging in the cell area across a group of row. The multiple rows need not be adjacent. Rows must be de-selected by clicking the row button again, or dragging again across the range of rows to be de-selected. **Exercise caution when more than one row is**



***selected, since the adding and deleting row commands will operate on all rows selected.***

## Clearing Data, Adding and Deleting Rows

Click the **right** mouse button anywhere within the Data Editor window. A menu will display the following choices: New Data, Insert Row Before, Insert Row After, Add Row to the End, Delete Row, Select all rows, and Unselect all rows. Select the desired action with the left mouse button.

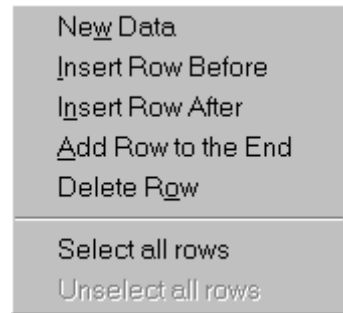

Figure 21-3 Data Editor Right Button Menu

**New Data** clears all the data presently in memory. Do not select this command unless you wish to replace all the data from the last sweep.

**Insert Row Before** is effective only if data is visible and a data row has been selected. In that case, Insert Row Before causes a row to be inserted immediately before the selected row. The row inserted will initially contain values in each cell which duplicate the values of the row which was selected. If multiple rows are selected when Insert Row Before is executed, a new row (with duplicate values) will be inserted before each of the selected rows.

**Insert Row After** is effective only if data is visible and a data row has been selected by clicking on it. In that case, Insert Row After causes a row to be inserted immediately after the selected row. The row inserted will initially contain values in each cell which duplicate the values of the row which was selected. If multiple rows are selected when Insert Row Before is executed, a new row (with duplicate values) will be inserted after each of the selected rows.

**Add Row to the End** will cause an additional row to be added at the bottom of the existing data. The initial contents of each cell will duplicate the values in the row above. If the Data Editor is empty, the Add Row to the End selection will add an initial row with values of one in each cell. The Data Editor will contain a column for each Source and Data parameter defined on the Sweep panel, and the column

headings and units will correspond to the parameter and units selected at each set of Source and Data control fields.



A new row can also be added to the end by pressing the down arrow on the keyboard if the last row is selected. The values in each of the new rows will duplicate the values in the last row. If the Data Editor is empty, clicking the left mouse button anywhere within an empty Data Editor and pressing the down arrow will add new rows. The values in each row in this case will be a nominal value “volunteered” by APWIN. To obtain new rows of user-entered data, edit the cells in the last row to the desired values, then press the down arrow which will duplicate those values in the new rows. This is normally the fastest way to create several rows, since the down arrow can be quickly pressed repeatedly.

**Delete Row** is effective only if data is visible and one or more data rows have been selected. The Delete Row selection of the right mouse button will then delete all selected rows.

**Select all rows** selects the entire contents of the data editor. **Unselect all rows** reverses this action.

## Entering and Modifying Values

---

A cell may be selected by clicking on the cell with the mouse cursor, or by using the horizontal and vertical arrow keys to move to the desired cell. The selected cell is indicated by blue inverse video. Typing from the keyboard and pressing the  key replaces the present contents of the selected cell. Pressing the  key while a cell is selected enables a character-by-character editing mode, permitting replacement of individual digits.

## Tabular Printout From Data Editor

---

The File Print menu command permits a tabular printout of the contents of the Data Editor (including any comments typed into the Comments Editor below the Graph Legend) as an alternative to a graph printout. Select the File Print command and the two subsidiary choices of Graph or Data will appear. Click Graph for a graph printout

or Data for a tabular printout. Clicking the Print icon on the toolbar  will always cause a graph printout.

## Exporting ASCII Data

To save the Data Editor contents in a format compatible with spreadsheets, word processors, and most other computer programs, select the File Export menu command. An Export file (.ADX) is an ASCII, comma-delimited file containing only the Data Editor contents including column headings.

## Viewing Data Graphically

If the Data Editor and the Graph are simultaneously visible on the same page, the graphic representation of the data points is shown simultaneously as each data value is entered or changed (see Figure 21-4). This is particularly useful when creating Limits files.

## Saving Data, Sweep, and Limit Data Files

When the Data Editor is complete for the intended Sweep Table or Limit application, use the Save As command, select Limit (.ADL) or Sweep (.ADS), as appropriate, as the file type, navigate to the directory (folder) where the file is to be stored, and supply an appropriate name for the file. It may then be “attached” (cross-referenced) to the desired test file or files by Opening the test file and using the Table Sweep

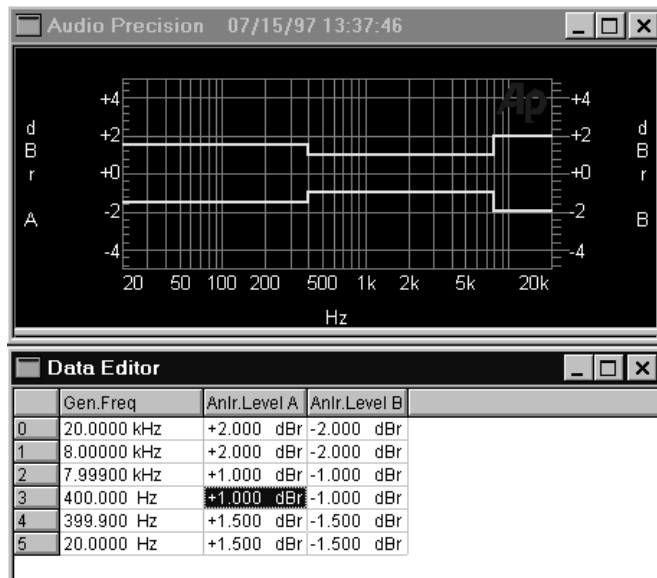

Figure 21-4 Data Editor and Graph Viewed Simultaneously

button at Source 1 or the Limits button at any Data section.

To save a data file, use the File Save As command. Select the “Sweep Data (.ADA)” choice to save the Data Editor contents and certain Sweep Panel information, but not all the instrument panel setups as are saved in a test file. Select the “Limit Data Files (.ADL)” choice to save the Data Editor contents to be used as acceptance limits for pass/fail testing. Select the “Sweep Table (.ADS)” choice to create a file to control the Source 1 parameter when Table Sweep mode is selected on the Sweep panel.

## Creating Limits

A limit file is an APWIN data file (.ADL file type) used as a standard for comparison of measurements in order to make Pass/Fail decisions. The Source 1 column of the data file must correspond to the Source 1 parameter of the test with which it will be used. For example, a frequency-swept test will have generator or FFT frequency at Source 1 and any limit files used with this test must also have Frequency at Source 1.

### Create Data File Columns

For each limit, there must be a data file column heading and numbers corresponding to the type of measurement to which it will be compared. The limit (data) file need not be created with the exact same units, but they must be in the same “domain”. For example, a data file stored with dBV units may be used with a test which plots amplitude in Volts, dBu, dBm, or any other analog amplitude units, but a data file stored with % units could not be used with a measurement in dBV or degrees.

Upper and lower limits, if both are used and are to be stored in the same data file, must have separate columns in the data file. Alternately, two different data files could be used as upper and lower limits.

To create the column structure for a limit data file, set up the Sweep Panel by selecting as Data 1, Data 2, etc. the parameters and units that are to have limits. Each Data n selection will produce one column in

the data file, following the first column which contains the Source 1 parameter.

Use two Data parameters for a measurement that will have both upper and lower limits if it is desired to have both limits in the same data file. One of these columns may then be used for upper limit values and the other for lower limit values.

Only one Data parameter needs to be selected for a measurement that will have only one limit (for example, distortion and noise measurements normally have only an upper limit).

If two measurements are to have exactly the same limit values (often the case for the two channels of a stereo device), additional columns need not be created for each since a single column in the resulting Data file may be used as a limit for multiple measurements. When one channel of a stereo device has been selected as Data 1 and the desired limit files connected via the Data 1 Limits button, checking the Stereo Sweep checkbox at the bottom of the sweep panel automatically selects the other stereo channel as Data 3 and automatically connects the same limits to Data 3 that have been specified for Data 1. See the Stereo Sweeps section in the Sweeps chapter for more details.

## Create Data File Rows

---

The data file used as a limit must have a row for each “break point” in the defined limit. If the limit values are to be constant across the entire sweep range, a two-row data file is sufficient. If the limit value is to change values at a single Source-1 value (step up or down at a specific value), there must be two rows for each segment in the Limits file. For example, if the limit is to be 0.02% from 20 Hz to 100 Hz, 0.01% from 100 Hz to 10 kHz, and 0.05% from 10 kHz to 20 kHz, three segments must be defined which will require a six-row data file. Values would then be typed in to create a Data file as follows:





Gen. Freq	Anlr THD Ratio
20 Hz	0.02 %
99.999 Hz	0.02 %
100 Hz	0.01 %
9.9999 kHz	0.01 %
10 kHz	0.05 %
20 kHz	0.05 %

New rows in the Data Editor may be created by pressing the down arrow when the cursor is in the last data row, or by clicking the right mouse button on the Data Editor and selecting the “Add Row to the End” choice.

Limits do not necessarily have to extend across the full Source 1 range swept by the test. For example, it might be desired to sweep from 20 Hz to 20 kHz but to only apply Pass/Fail limits between 50 Hz and 10 kHz, with the data outside that range measured and graphed only for informational purposes.

When editing is complete, use the Save As command, click the down arrow at the end of the “Save as type” box, and select “Limit Data files (\*.ADL)”. Click in the File Name box and type in the name you wish to assign to this limit file, and click the Save button.

## Attaching Limit Data Files to Tests

A cross-reference must be established in order for a test file to use the proper limits file or files (.ADL file type) as limits during a sweep. This cross-reference is established by use of the “Limits . . .” buttons in the Data 1 and Data 2 areas of the Sweep Panel and the “Limits 3 . . .”, “Limits 4 . . .”, “Limits 5 . . .”, and “Limits 6 . . .” buttons on the large form of the Sweep Panel for Data 3 through Data 6. The Sweep Panel may be switched between large and small forms by clicking on the central of the three icons at the right of the Title Bar of the Sweep Panel, or press the   or   keys.

Clicking on any of the “Limits” buttons displays a dialog box (see Figure 21-5) which permits specifying the file and the column of data within that file to be used for Upper and Lower limits. It is not

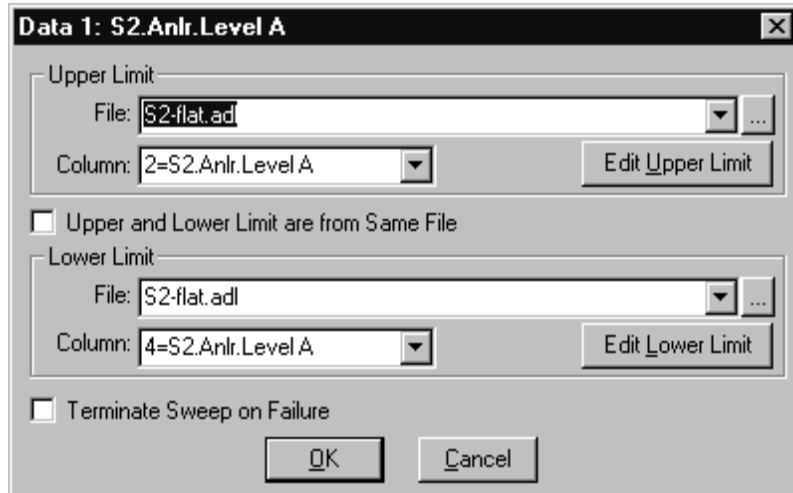



Figure 21-5 Limits Dialog, Obtained via Limits Button for each Data Parameter.  
Note Edit Upper Limit and Edit Lower Limit Buttons to Display Attached File Editor

necessary to specify both Upper and Lower limits; either may be left as “None”. Clicking on the ellipsis button  at the right of the File box will display a browser box which permits navigating to the disk directory (folder) where the .ADL limits file is located. Double-click on the desired file name, or single-click and then click on the Open button. If the Upper and Lower limit values are stored in the same data file, check the “Upper and Lower Limits are from Same File” box and the file name will be automatically selected in the other File box. When the file has been selected, clicking on the down arrow at the right of the Column box produces a list of the column head labels in that file. The desired column can be selected by clicking on it. If you need to view the limit file contents in order to know which column to select, click on the Edit Upper Limit or Edit Lower Limit button to bring up the Attached File Editor.

## Attached File Editor

The Attached File Editor is similar in format to the Data Editor, but is intended only for viewing and modifying existing Limit files and Sweep Tables. The Attached File Editor is accessible only by clicking the “Edit” button in the Table Sweep dialog box or the “Edit Upper Limit” or “Edit Lower Limit” button in the Limit dialog box. Clicking

the Edit button will automatically load the attached limit file or sweep table. The column corresponding to the Edit button will be marked with two asterisks (\*\*) in the column head. For example, if the Edit button in the Lower Limit section of the Data 2 Limits dialog is clicked, \*\* will appear in the heading of the Data 2 Lower Limit. Exact numerical values may be determined from the tabular display and values may be changed or added exactly as described above in the Data Editor sections.

If one or more values are changed in the Attached File Editor, a dialog will be displayed when the Attached File Editor is closed, warning the user that the modifications will have no effect unless the file is saved. If the “No” option is chosen, the changes will be lost and the file will not be modified. If the “Yes” option is chosen, the old version of the file will be over-written with the new version. There is no provision for saving an edited file in the Attached File Editor to a new name.

## Actions Upon Failure

**Sweep Halt:** The user can choose to have a sweep test halt immediately if a data point is taken outside the acceptable limits by checking the “Terminate Sweep on Failure” checkbox on the dialog which appears when the Limits button is clicked. If this box is not checked, the sweep will continue to its conclusion independently of whether data points are outside limits.

**Tabular Display Codes:** When Tabular display is checked on the large version of the Sweep panel, or when the Data Editor is used to examine data, measured points above the upper limit are indicated with an “L” and measurements below the lower limit are indicated with a “U”.

**Log File:** When the Log Errors feature of the Utilities Configuration menu is enabled, two different actions may be taken related to measurements failing limits. The “Pass/Fail Message” feature causes a text message to be written into the log file, telling whether or not all points passed limits or at least one point failed. The message also summarizes the number of failures of the upper and lower limits, and may include the test name and the date and time the test ran.



The “Log Sweep Data” feature, with either “All” or “Failed Only” options selected, will write the actual measured values into the log file with an indication of whether the upper or lower limit was failed and the value of the limit which was failed. An example of a log file is shown below:

```
C:\Program Files\APWIN\SAMPLES\sample.at1
Sample Response Test w/Limits 07/09/95 11:10:13
FAILED : Lower Limit 3, Upper Limit 4, Timeouts 0
Gen.Freq(Hz)      Anlr.Level A(dBr)
20000             5.000000(>2)
10022.5           4.200000(>2)
5025              2.100000(>1)
2517.5            1.800000(>1)
79.625            -1.800000(<.5)
39.9              -2.100000(<.5)
20                -2.700000(<.5)
```

The first line is the test file name and path. The second line is the Graph Title, date, and time. The third line is the “Pass/Fail Message” which summarizes failures. The “Failed Only” option was in use, so the remaining lines consist of the points which were outside limits. The points below 2517.5 Hz and above 79.625 Hz were within limits and thus are not shown. The “greater than” (>) and “less than” (<) symbols and numbers at the end of each row show where the value was above the upper limit or below the lower limit, and the value of the limit itself.

For more information on log files, see the Log Files section of the Menus chapter.



## Compute Menu

The Compute Menu consists of commands to operate a number of algorithms which perform computations on the data set resulting from a sweep. These various computational utilities can “push” data curves up or down the graph so as to go through a specific data value at a specific horizontal point, invert a curve, fit a straight line to a data set and subtract all data values from that straight line, compute the difference between the data in memory and the data in a user-specified data file on disk, and a number of other useful operations. The Compute Menu consists of the following commands: Normalize, Invert, Smooth, Linearity, Center, Delta, 2-Sigma, Average, Minimum, Maximum, Equalize, Clear All.

### General Operation, Computational Utilities

Selecting any Compute command except Clear All will display a dialog box generally similar to the example shown in Figure 22-1. A column of six check boxes labeled Data 1 through Data 6 is common to all compute utilities. Checking the box next to any Data trace selects that trace for input to the computational algorithm. If the error message “No Compute Performed” is received when a computation is attempted, it often is because no box was checked to select the data to be computed. The computed results will replace the original data, in the same trace. Several traces can be checked if desired and all will be computed in one operation of the Compute (or Compute and Close) button if the data in all traces is compatible with the

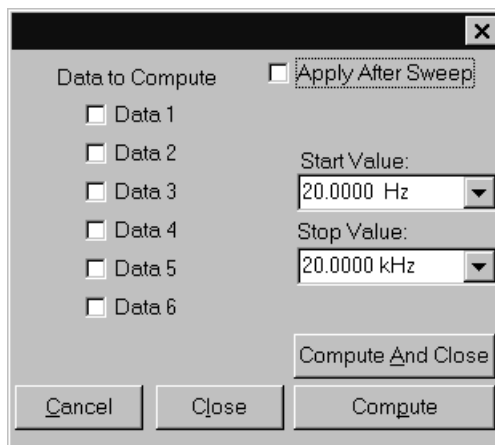

Figure 22-1 Typical Compute Dialog

particular computation. Any data traces not checked will not be computed.

If it is desired to retain the original data and view both original and computed data, the test should initially be set up to graph the same parameter on two traces such as Data 1 and Data 3, for example. Then, the Compute dialog checkbox for Data 3 can be checked and the Compute button clicked, resulting in computed results as Data 3 with the original data still in Data 1.

When the box or boxes have been checked to select the Data sets which are to be computed, the computation can be triggered by clicking on either the Compute or the Compute and Close button. The Compute button triggers a computation and leaves the Compute dialog box visible for additional operations, while the Compute and Close button triggers the computation and removes the dialog box. Several different computations may be manually made in sequence by selecting the same trace in different Compute dialogs and operating the Compute or Compute and Close button. Different computations may also be automatically “chained”; see below. The Close button may be used at any time to remove the Compute dialog from view while retaining any changes which have been made. The Cancel box will remove the dialog from view without retaining changes made since it was opened.

It is also possible to set up an automatic computation or sequence of computations each time a sweep is run by checking the “Apply After Sweep” checkbox at the top of a dialog or several dialogs. When this box is checked and the Close button is clicked, each time a sweep is run the selected computation will automatically take place following the last data point of the sweep. If upper and/or lower limits have been attached to a test and the “Apply After Sweep” box is checked, the data will not be compared to limits until after the computation is made. Computations can be chained in any sequence desired. First, execute the Compute Clear All button to clear all previous settings. Then, set up each desired compute function in the intended sequence of operation, checking the “Apply After Sweep” box and clicking the Close button. When the test is operated, it will perform each compute operation in the sequence in which they were set up.

Many of the Compute utilities have one or two additional numeric fields to define which point or range of the input data will be used as a reference for the computation.

## Compute Normalize

The Compute Normalize command moves a trace (data set) up or down the graph so that the trace goes through a user-specified Y-axis value at a user-specified X-axis value. A typical use for Compute Normalize is to convert actual measured data from a “golden unit”, such as a reference loudspeaker, into upper and lower limit curves for use in repetitive production testing. For example, a test result could be pushed upwards by 3 dB and saved as an upper limit, then pushed downwards 3 dB from the original value and saved as a lower limit.

The Compute Normalize dialog includes two numeric entry fields: Horizontal Value and Target Value. The Horizontal Value field is used to specify at which point across the X-axis the Target Value will be achieved in the computed result. The Target Value field is used to specify the desired new Y-axis value at the specified Horizontal Value. Both fields have the full range of units available which apply to the data set being computed.

If two or more Data boxes are checked in the Compute Normalize dialog before the Compute button is clicked, all checked traces will be normalized to the entered Target Value at the entered Horizontal Value if all are in the same “domain”; for example, if all are amplitude or level readings. If any of the traces checked contain incompatible data (for example, level data on the first selected trace and phase data in degrees on another trace), an error message

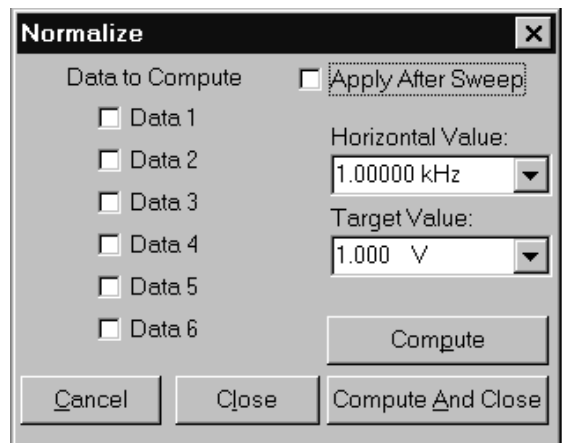

Figure 22-2 Compute Normalize Dialog

will be received when the computation is attempted since a single Target Value cannot work for two domains.

## Compute Invert

Compute Invert turns a curve upside down. A typical application of Compute Invert is to turn over the result of a frequency response measurement on the test system itself, including connecting cables with their response variations, in order to use the result as an Equalization curve and thus correct for systematic response variations.

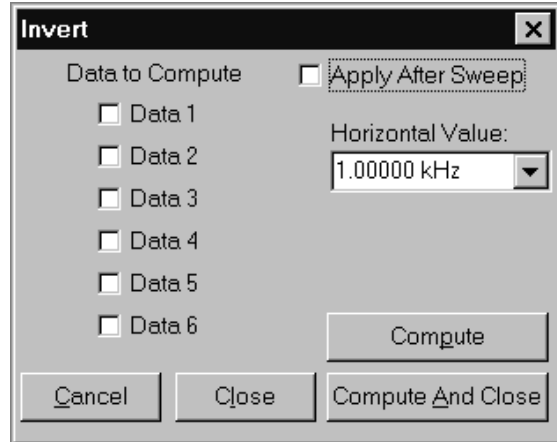

Figure 22-3 Compute Invert Dialog

The Compute Invert dialog has a single numeric entry field for Horizontal Value. The data inversion will be performed around the value at the specified Horizontal Value as a pivot point.

## Compute Smooth

The Compute Smooth utility performs a running 3-point smoothing on the selected data set. Smoothing is sometimes used for loudspeaker sinewave frequency response measurements, based on the assumption that sharp peaks and dips are probably the effects of room reflections and cancellations rather than actual speaker response variations and are thus better removed.

The Compute Smooth dialog contains a numeric entry field for “Passes” and an “Auto” checkbox. One pass means going through the data set once, replacing each measured value with the computed average of that point and the two adjacent horizontal measurement values. If the entry in the “Passes” field is greater than one, the

smoothing process is repeated the specified number of times. Checking the “Auto” box causes the Passes field to gray and the software selects a number of passes based upon the number of measurement points in the data.

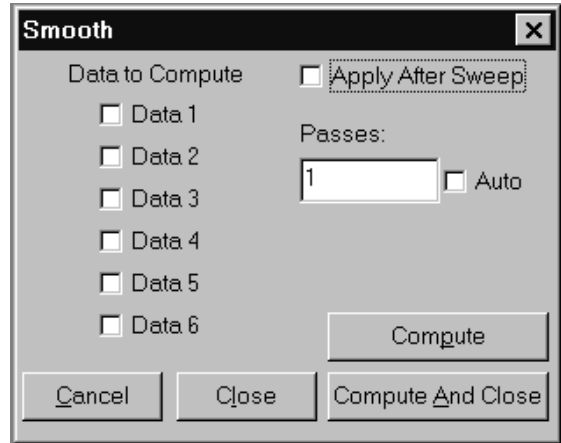

Figure 22-4 Compute Smooth Dialog

## Compute Linearity

The Compute Linearity utility performs two mathematical operations in sequence. First, the best straight line is fitted to the data values within a user-specified range of data, using the least squares method. Second, every data value in the set is subtracted from the straight line just computed. The result is a graph of deviation from perfect linearity. The Compute Linearity utility is normally used on measurement data such as an output-amplitude-vs.-input-amplitude sweep of an A/D or D/A converter, or on the output-input phase shift through a device under test such as a loudspeaker.

The Compute Linearity dialog has two numeric entry fields, labeled Start Value and Stop Value. Entries into these fields specify the horizontal range of data values to which the straight line will be fitted. Especially in the case of an output amplitude

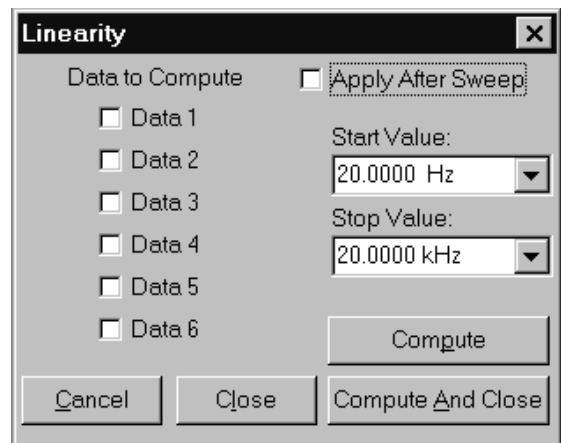

Figure 22-5 Compute Linearity Dialog

versus input amplitude sweep across a wide dynamic range, measurements at the higher amplitudes may be compressed or clipped and measurements at the lower amplitudes may be noise-limited. The Start and Stop Value fields permit specifying a reference range where these effects are likely to be minimal. The Start and Stop Values are used only in the straight line fitting portion of the process; after the line is derived, every data point—inside and outside that range—is subtracted from the straight line.

The results of Compute Linearity, showing only deviations from perfect linearity, will normally span a much smaller Y-axis range of values than the original measurement values. The Optimize commands available by clicking the right mouse button on the graph will select new graph top and bottom values in order to re-display the data with the best possible resolution.

## Compute Center

The Compute Center utility can only be used with data sets that have both upper and lower limit files attached. See the Limits chapter for more information on limits. The purpose of the Compute Center utility is for cases where the shape of a device's frequency response curve is much more important than the exact absolute amplitude of the measurements. This is commonly a case in microphones, for example, where small variations in output level (sensitivity) are easily compensated for in actual usage by adjustment of a gain control. The Compute Center utility will compare all measurement values within a specified horizontal range to the upper and lower limits and then push the data up or down the Y-axis to

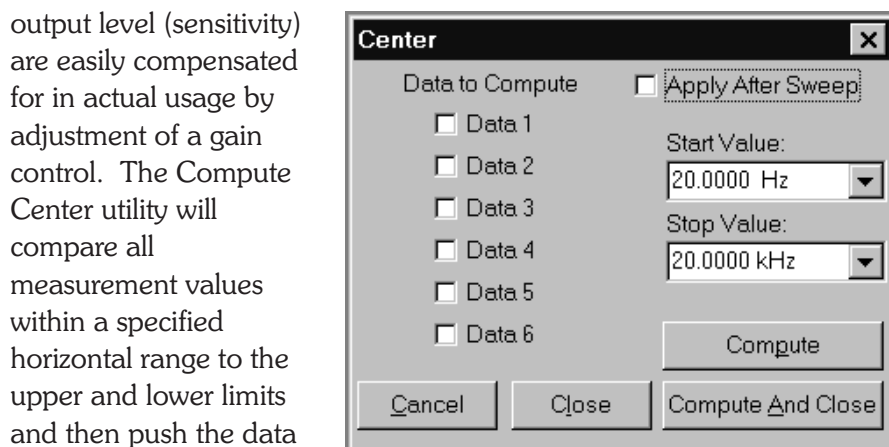

Figure 22-6 Compute Center Dialog



best center it between the limits.

The Compute Center dialog includes Start Value and Stop Value numeric entry fields. These are used to enter horizontal axis values between which the measured data and limits are compared. Data outside that range will be not be compared to the limits for purposes of moving the data vertically for best fit within the limits. However, all data within the range defined by the limit files themselves will then be used by APWIN software for the PASS/FAIL decision making following a Compute Center if the “Apply After Sweep” box is checked.

## Compute Delta

The Compute Delta utility will subtract the data values in a user-specified data file (.ADA, .ADL, .ADS, or .ADQ) on disk from the measurement data presently in memory, or will subtract the data in one column in memory from the data in another column. This feature can produce after-the-fact equalization when the disk file is an EQ curve, can subtract out an offset if the disk file is a constant value, or can subtract one channel of stereo data from another to display inter-channel difference

The Delta Source must first be selected in the field near the bottom of the dialog. If the source is to be a data file previously saved to disk, click on the ellipsis button at the right end of the field and use the

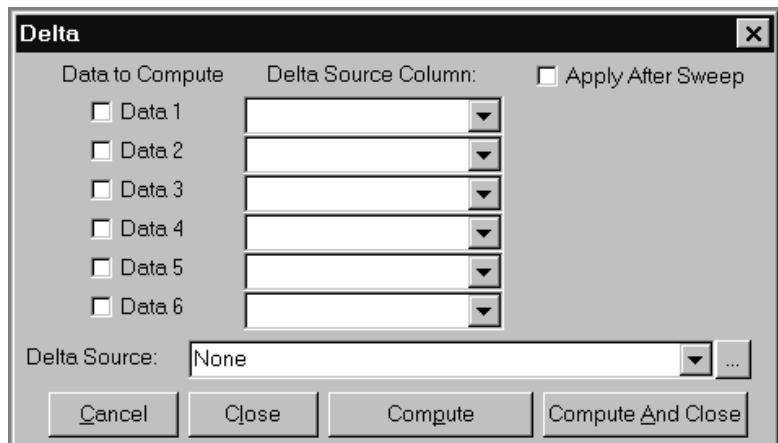

Figure 22-7 Compute Delta Dialog

browser to navigate to the desired directory and file name. Only data files (.ADA, .ADL, .ADS, or .ADQ) may be selected. If data in a test file (.AT2C) is to be used as a Delta Source, load the test file, use the File Save As Data command to save the sweep data contents into a data file, and select that new data file as the Delta Source.

It is also possible to use the measurement results data presently in computer memory as the Delta Source. Click on the down arrow (not the ellipsis button) at the right end of the Delta Source field and select “Sweep Data” instead of a data file name. This can be useful in order to subtract (for example) right channel response from left channel response of a stereo device to obtain a graph of the difference in response of the channels.

When a Delta Source has been selected, it is then necessary to select a particular column of data in the file or computer memory which is to be subtracted from the measurement data. The Delta Source Column field at the right of each checkbox permits selection of any of the columns in the specified Delta Source. Clicking on the Compute or Compute and Close buttons will then replace the data of the selected trace with the difference between the original trace values and the selected Delta Source Column of data.

## Compute 2-Sigma

The Compute 2 Sigma utility is used with a series of wow and flutter measurements versus time (chart recorder style) when it is desired to have a single number representing the wow and flutter performance. The 2-Sigma value for a series of wow and flutter measurements is defined as the magnitude value

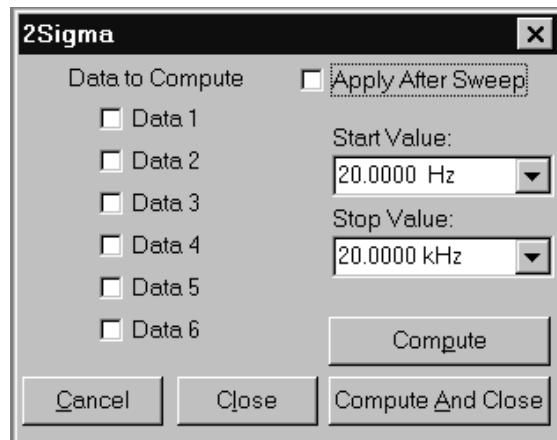

Figure 22-8 Compute 2-Sigma Dialog

that is exceeded exactly five percent of the time. This is based on the fact that five percent of the values in a Gaussian distribution will exceed the two standard deviations (two sigma) value above the center. In fact, there is no reason to suppose that a series of wow and flutter measurements will have a Gaussian distribution, but the 2-Sigma standard for wow and flutter is defined in this fashion.

The Compute 2 Sigma dialog includes numeric entry fields for Start and Stop values. Entries in these fields specify the horizontal range of data that will be included in the calculation. Particularly in the case of wow and flutter measurements, an initial large transient may exist for several seconds due to the long time constants of wow and flutter detectors. The Start and Stop fields may be set to exclude such an initial transient.

Note that the Compute 2-Sigma utility replaces every original measured value with the computed result, so a horizontal line on the graph results and the Data Editor view of the data will show every value to be identical.

## Compute Average

The Compute Average utility will compute the average value of all the points in the data set between the Start Value and the Stop Value and replace every measured value with that computed average. Data values outside the range will not be included in the computation of average value, but all values in the entire data set will be replaced with the value computed.

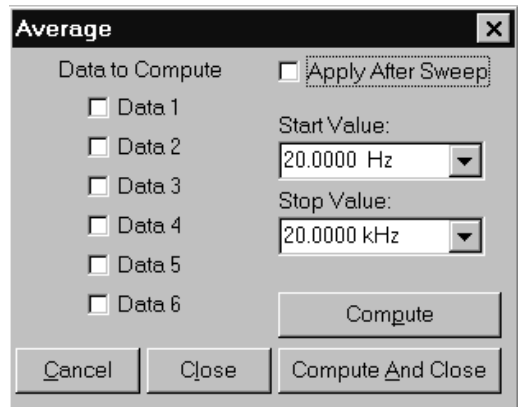

Figure 22-9 Compute Average Dialog

## Compute Minimum and Compute Maximum

The Compute Minimum and Compute Maximum utilities will find the minimum or maximum value in a sweep (data set) and replace every measured value with that value. The Start Value and Stop Value fields may be used to define a horizontal range of data to be searched. Data values outside the range will not be included in the search for minimum or maximum value, but all values in the entire data set will be replaced with the value found.

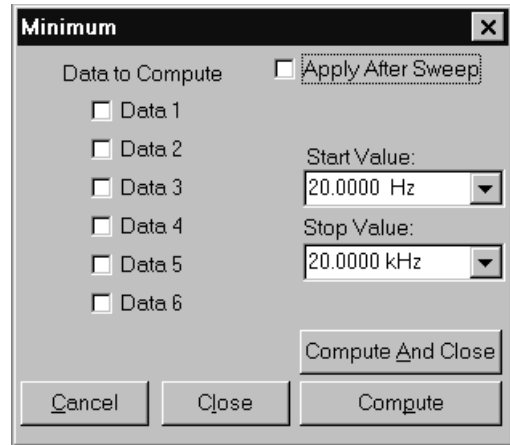

Figure 22-10 Compute Minimum Dialog; Compute Maximum is Identical

## Compute Equalize

The Compute Equalize function multiplies the value of every measurement point in the selected data set by the value at the corresponding horizontal (frequency) point in a specified .ADQ file on disk. Compute Equalize thus has a similar result, following a sweep, to the EQ Sine “waveform” available for the analog and digital generators, except that the EQ Sine functions make real-time changes in generator output levels

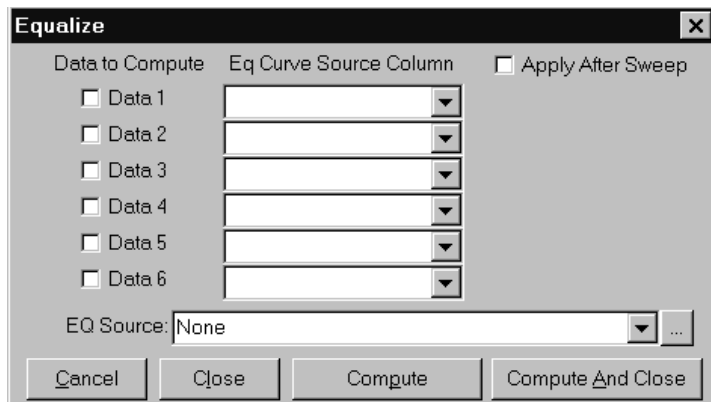

Figure 22-11 Compute Equalize Dialog

while Compute EQ is a one-time computation normally made following a sweep test. Compute Equalize interpolates between data points in the specified .ADQ file as necessary to produce values precisely at the data point horizontal values.

---

## Compute Clear All

The Clear All command of the Compute menu clears all settings of all Compute functions to their normal default settings.





## Automating Tests

Automation speeds up testing activities and reduces or eliminates the normal boredom when humans perform repetitive actions. There is a significant degree of automation in simply saving a test file and later opening it to recreate the same setup. Much greater degrees of automation are available in APWIN through Procedures (.APB files), sometimes also referred to as Scripts or Macros.

Procedures are computer programs that define sequences of operations. A procedure may load test files from disk and may make changes directly to any field of any panel. Procedures may run linearly from top to bottom or may branch to different sections or to other procedures, depending upon measurement results or operator input from keyboard or mouse. Procedures may display menus and dialogs to the users, with a variety of methods including buttons, checkboxes, and text entry areas for the user to enter data or control the program flow. Procedures may send graphs or tabular data to printers, may save information to disk, and may communicate with other Windows programs. Procedures are normally written in APWIN Basic, furnished as a standard part of APWIN. Microsoft Visual Basic-4 or Visual Basic-5 may also be used to write programs in the APWIN Basic language. APWIN Basic is compatible with Microsoft Visual Basic for Applications. Since APWIN Basic complies with the Microsoft OLE (Object Linking and Embedding) specification, it is possible to control System Two or System One from other Windows programs such as a spreadsheet or word processing program.

An existing procedure may be loaded from disk by the File Open Procedure command. The resulting dialog box permits navigation among directories (folders), displaying the procedure (.APB) files in the selected directory. When an .APB file is opened, the program (listing) will be shown in the Procedure Editor if the Procedure Editor is visible. Once loaded, the procedure may be executed by the Run Procedure





icon on the Procedure Toolbar or from the Menu by the Procedure Run command (  ).



Changes may be made to the procedure in the Procedure Editor. Trouble-shooting of a procedure that is not functioning satisfactorily may be aided with several de-bugging tools. These include break points, single-step operation, and evaluation of expressions. User dialogs may be created which include buttons, prompting messages, and user input of text and numbers. For more details on de-bugging and editing procedures, see *Getting Started with Procedures*, the APWIN Basic Programmers Manual, or *Help APWIN Basic Editor*.

New procedures, or additions to existing procedures, may be generated by two different techniques. One method, suitable for those with some experience with programming techniques and knowledge of the specific syntax and commands of APWIN Basic or other forms of Visual Basic, is by typing and modifying text in the Procedure Editor. The second method, suitable even for users with little or no experience in programming or APWIN Basic, is via the LEARN mode (Procedure Learn Mode menu command). Starting LEARN mode causes each ensuing user mouse click and keyboard entry to write a line of APWIN Basic code into the Procedure Editor. Simple procedures may be completely generated in LEARN mode. More sophisticated procedures with branching, calling of sub-procedures, processing of data results, etc., can have their core created in LEARN mode but will typically require further commands to be added in the Procedure Editor. For more details on these topics, see *Getting Started with Procedures*, the APWIN Basic Programmers Manual, or *Help APWIN Basic Editor*.

## LEARN Mode

LEARN mode is started with by clicking on the Learn icon  on the Learn toolbar , or by the Procedure Learn Mode menu command (Alt R R) or Utilities Learn Mode. Once Learn mode has been started, every user action will result in one or more lines of program code written into the Procedure Editor until Learn mode is halted. If a procedure has already been loaded into the Procedure Editor, the commands created by Learn mode will be inserted at the cursor position in the Procedure Editor. If no procedure has been loaded, the Procedure Editor will be opened with a new (blank) procedure ready for recording of the Learn mode commands. To stop



Learn mode, click on the Stop Learning icon  or use the Procedure Learn Mode or Utilities Learn Mode command again to toggle Learn Mode off. To temporarily suspend the learning of commands, hold down the   keys while clicking the mouse to make changes which will not be learned.

For a Learn Mode example, assume the following list of user actions:

- Click on Start Learn mode icon.
- Click on New Test icon.
- Click on analog generator On/Off control.
- Click on analog analyzer Ch A input and select Gen Monitor instead of XLR Bal.
- Click on page 2 tab.
- Click on GO (or press ).

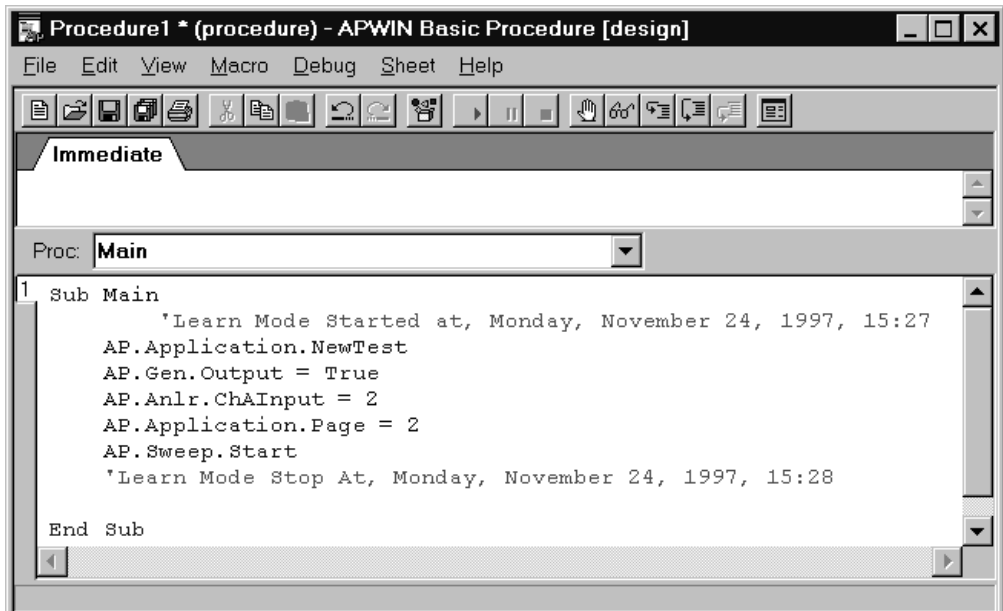

Figure 23-1 Learned Procedure Example

- Click on Stop Learn mode icon.

Opening the Procedure Editor should show the program listing as illustrated in Figure 23-1. This procedure will duplicate all the actions above if the Run Procedure icon is clicked.

## Optimizing Automation Speed

---

Many considerations affect testing speed. Some of the more important factors are listed below, with suggestions on alternatives that may result in faster testing.

### Computer Characteristics

---

The computer processor type, clock rate, amount of memory, type of graphics card and amount of graphics card memory all have a strong effect on the speed of most tests. The computer specifications particularly affect “compute intensive” operations such as the speed of “painting” panels and graphs on screen when a test is loaded, time required for the Compute utilities, etc. Use faster computers with more memory and fast graphics cards with more graphics memory to speed up operation.

### Other Programs Running

---

The number and complexity of other programs running simultaneously on the same computer affect testing speed. For the fastest audio testing speeds, shut down as many other programs as possible while running APWIN. This is particularly true for programs which may respond to external stimulus (e-mail, etc.).

### Number of Sweep Points

---

200-point sweeps take longer than 10-point sweeps. For fastest testing, take data at only the number of points truly required. If the required point density is greater across some portions of the spectrum than others, consider use of Table Sweeps via an .ADS file which contains a list of specific points at which measurements will be made.

## Type of Measurement

---

For example, THD+N sweeps are slower than Level sweeps due to the necessity of tuning the bandreject filter to each new frequency and waiting for measurements through the filter to stabilize. One cannot normally substitute a level measurement for a THD+N measurement, of course, but it may be appropriate to compromise to a small number of points in a THD+N sweep in recognition that each point is relatively slow.

## Single vs. dual channel (stereo)

---

The System Two analog and digital analyzers have two Level meters and so can make level and response measurements of a two-channel device in the same time as for a single channel. Likewise, the FFT-based programs are two channel and have almost no speed penalty for measuring both instead of only one. However, a number of the real-time measurements made with the main (reading) meter, such as THD+N, can be made only on one channel at a time. For the greatest speed with such measurements on a two-channel device, a stereo sweep automatically sweeps one channel, changes input and output connections, and sweeps the second channel in less time than loading and running separate tests for each channel. For measurements that must be made sequentially on the two channels, speed is improved by minimizing the number of measurement points. An alternate technique such as multitone, based on two-channel FFTs, should be considered for the greatest speed on stereo devices.

## Autorangeing in analog analyzer vs. fixed range selections

---

When signal levels change, autorangeing takes time to find the correct new range. When a test is loaded with ranging set to auto, the analyzer must adjust itself to the present value. If the test is loaded before the device under test is connected or stabilized, the analyzer may first range down to the noise level, then range up again after signal appears. When the signal level is known within reasonable limits, fixed range operation is much faster. The risk is that an unexpected change in signal level may cause clipping or noise-limited measurements in the analyzer.

## **“Keep all readings active” feature**

---

When the “Keep all readings active” option is selected in the Utilities Configuration dialog, APWIN during sweeps must pass readings from every measurement section of the instrument to its display location on the computer screen, even though that particular measurement is not being plotted. Sweeps will be slower as a result. For fastest speed, turn off the “keep all readings active” feature unless it is important to be able to watch some measurements on an instrument panel or bargraph while others are being plotted on the Graph.

## **Sweep Settling**

---

The values on the Sweep Settling panel for the particular measuring instruments being graphed may have a strong impact on sweep speed. If the Delay value is 100 ms instead of 30 ms, an additional 70 ms is spent at every step of the sweep. If Tolerance is 0.1% instead of 2%, it will take longer at every step of a sweep for the stream of measurements to stabilize within that narrower range. For the fastest sweep speeds, use the largest value of Tolerance consistent with the repeatability desired for the data. Use the smallest number of Points and the shortest Delay which provide repeatable data. However, when testing devices with significant time delay such as satellite links or three-head tape recorders, the Delay value must be at least as long as the known time delay through the device under test. Use the Exponential rather than Flat Algorithm if repeatability is acceptable.

## **Multitone vs conventional swept sinewave testing**

---

Multitone testing normally provides much faster results than swept sinewave techniques. For example, a 31-tone multitone signal can provide response, distortion, noise, and phase measurements on a stereo or mono device in a few seconds, compared to perhaps 45 seconds or one minute for the same types of measurements at the same 31 frequencies via conventional swept sinewave techniques. Response and phase measurement results are normally identical between swept sine and multitone techniques. Distortion and noise measurements are made by fundamentally different methods in the

two techniques, so there is no simple answer to the question of correlating results from the two types of measurements. It is typically necessary to characterize a known-good device with multitone techniques in order to determine suitable test limits.

### Analog hardware analyzer vs. DSP audio analyzer

The digital analyzer with the filter-based DSP Audio Analyzer program (ANALYZER.AZ2) selected and Low Bandwidth (1x) A/D as the Input can make many of the same measurements as the analog hardware analyzer. The DSP-based program has several features that provide greater speed than the analog analyzer. The Fast RMS detector is a synchronous detector that measures across a small number of complete cycles of the signal rather than for a longer, fixed measurement period. Reading rates up to 128 readings per second are available. Response measurements with the Fast RMS detector may be several times faster than response measured with the analog hardware analyzer. The compromises are in response flatness, repeatability, residual distortion and noise, and bandwidth.

	<b>Analog Hardware Analyzer</b>	<b>DSP Audio Analyzer, HiRes A/D, RMS Detector</b>	<b>DSP Audio Analyzer, HiRes A/D, Fast RMS Detector</b>
<b>Frequency Range</b>	10 Hz-200 kHz	10 Hz-30 kHz @65536 Hz rate	10 Hz-30 kHz @65536 Hz rate
<b>Frequency Response Flatness 10 Hz-20 kHz</b>	±0.008 dB (typically ±0.003 dB)	±0.04 dB typical	±0.04 dB typical
<b>Max. Data Spread, 10 sweeps, 20 Hz-20 kHz</b>	±0.003 dB typical, settling tolerance 0.03%	±0.04 dB typical, settling tolerance 1.0%	±0.04 dB typical, settling tolerance 1.0%
<b>Stereo Response Sweep Speed, 31 Pts 20-20k</b>	7 seconds typical, analog generator	5.3 seconds typical, sine (D/A) generator	1.5 seconds typical, sine (D/A) generator

<b>Residual THD+N 1kHz, 2 V, 22/20 kHz BW</b>	Typical 0.00017% (-115 dB)	Typical 0.00054% (-105 dB)	Typical 0.00054% (-105 dB)
---	----------------------------------	----------------------------------	----------------------------------

### **Bandpass/Bandreject Filter Tracking Methods**

DGen tracking, AGen tracking, or Sweep Track will all produce faster sweeps in THD+N, Bandpass, Bandreject, or Crosstalk measurement functions than the Counter Tuned alternative. The various “Track” selections avoid the time necessary to produce a stabilized frequency reading at each step of a sweep before sending the frequency value to the BP/BR filter. This is true of both analog hardware and digital analyzers.

### **Mouse activity during a sweep**

Keeping track of mouse movements on the screen during a sweep uses part of the PC processor’s capability and consequently slows down the sweep.

### **Analog vs. DSP-D/A Generator**

The DSP generator and D/A converters are selected by the several analog generator waveform selections with “(D/A)” as part of the waveform name. This DSP generator has no frequency range switching and stabilizes in amplitude faster at each new frequency than the analog hardware generator, so should be used for the fastest sweeps when its distortion and flatness are acceptable. The major performance specifications are compared below.

	<b>“Sine” Waveform Selection</b>	<b>“Sine (D/A)” Waveform Selection</b>
<b>Frequency Range</b>	10 Hz-204 kHz	10 Hz-47% of sample rate (~31 kHz @ 65536 Hz)
<b>Frequency Response Flatness, 10 Hz-20 kHz</b>	±0.008 dB (typical ±0.003 dB)	±0.03 dB to 30 kHz

**Residual THD+N, 20  
kHz BW (system  
spec, including  
analog analyzer)**

0.0004% (-108 dB) 0.0007% (-103 dB)

## **Loading set-ups as tests vs. changing parameters from a procedure.**

---

In a procedure, changed instrument set-up conditions can be achieved by loading test files (.AT1/.AT2/.AT2C) from disk for each new or modified setup. Changes can also be implemented by sending commands directly to the individual instrument parameters. Where only a few settings or values must be changed from the previous setup, it is normally faster to send commands from the procedure since several lines of a procedure can be executed in less time than it takes to load a complete test. If many changes must be made, it may be faster to load a test. Loading a test has the advantage of guaranteeing a new, fixed set-up. Incremental changes depend upon the instrument condition at the start of the changes, so modifications to earlier portions of the procedure or to a test loaded earlier will produce a different result.

## **Time taken by the PC and Windows to draw the various panels and graphs on screen**

---

The PC takes a finite amount of time to draw each window (panel, graph, etc.) on the currently displayed page of workspace. It is not necessary for any panels, or even a graph, to be displayed during completely automated testing if limit files are being used to produce pass/fail results. The fastest test loading will occur if no windows are displayed. While this can be achieved by “killing” all panels and graphs before saving a test, that test is then awkward to modify or use in an interactive mode. The “AP.Application.Visible” group of procedure commands may be used as global commands at the beginning of a procedure to inhibit the display of all panels or of certain types (panels, graphs, bargraphs, etc.) in all tests of the procedure. User dialogs will still be displayed.





# Switchers

## APWIN Panel



The SWR-122 and SWR-2122 switchers are high-performance 2 x 12 relay switching matrices, stackable up to 16 units (192 channels). SWR-122 family switchers are no longer available, so only the SWR-2122 switchers will be described in this manual. SWR-2122 family switchers are available in four versions:

- a balanced Output Switcher (SWR-2122M) with 12 male XLR connectors, to fan out the analog generator's two outputs to as many as 12 device inputs. Complement mode may also be selected which drives all except one output connector.
- a balanced Input Switcher (SWR-2122F) with 12 female XLR connectors, to fan into the analog analyzer's two inputs from as many as 12 device outputs
- a balanced Patch Point, or insertion, switcher (SWR-2122P) with 12 5-pin XLR connectors carrying both input and output circuits. Each output pair of pins is "normalled through" to the input pins on the same connector when the control relay is not operated, but can break the path when desired to insert a signal
- an unbalanced switcher (SWR-2122U) with female BNC connectors instead of XLR connectors. Via rear panel switch settings, it can be made to function as an Input or Output switcher.

To bring the Switcher panel to the screen:

Mouse: click on the Switcher icon  on the Panels Toolbar, or the Panels Switcher menu command.

or

Keyboard: press the    keys (for Panels sWitcher)

The Switcher panel controls from 1 to 32 switcher modules (up to 16 input and 16 output). Each unit is an independently powered external accessory, connected in

“daisy chain” fashion to the same Audio Precision interface bus as the measurement instrument and computer.

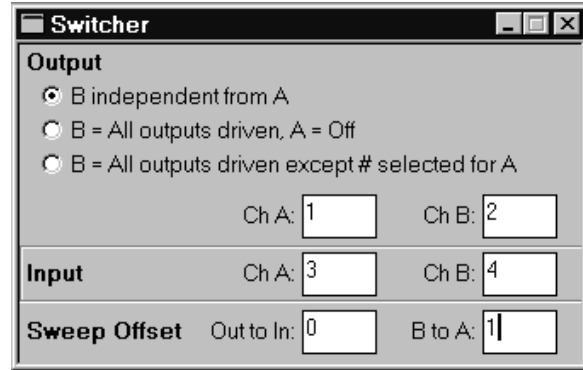

Figure 24-1 Switcher Panel

The Switcher panel permits selecting any desired input and output connector. The switchers may also be controlled as a swept parameter in order to scan a measuring instrument across many device outputs, or to scan a stimulus parameter across many device inputs. The Sweep panel, not the Switcher panel, determines this type of operation. The Switcher panel settings will determine the switcher conditions before a switcher sweep begins and after it ends.

## Input Channel

The channel numbers entered in the Input Channel A and Input Channel B fields determine the Input switcher connections unless a switcher sweep is in progress. The acceptable range of numbers for each field is from 1 to 192, since up to 16 Input switchers may be used. The practical range depends upon how many switchers are connected and how the rear panel switches are set on each switcher. Typically, the rear panel switches are set at installation time so that the first Input switcher responds to control as channels 1-12, a second Input switcher (if present) is set as channels 13-24, etc. Entering a zero or a number beyond the range of Input switchers actually present causes there to be no connection.

To sweep across switcher channels during a sweep test, the Sweep Panel Source 1 or Source 2 Browser must be used to select **Swr** as the

instrument and the particular channel and sweep mode desired as the parameter.

## Output Channel

The channel numbers entered in the Output Channel A and Input Channel B fields determine the Output switcher connections unless a switcher sweep is in progress. The acceptable range of numbers for each field is from 1 to 192, since up to 16 Output switchers may be used. The practical range depends upon how many switchers are connected and how the rear panel switches are set on each switcher. Typically, the rear panel switches are set at installation time so that the first Output switcher responds to control as channels 1-12, a second Output switcher (if present) is set as channels 13-24, etc. Entering a zero or a number beyond the range of Output switchers actually present causes there to be no connection.

To sweep across switcher channels during a sweep test, the Sweep Panel Source 1 or Source 2 Browser must be used to select Swr as the instrument and the particular channel and sweep mode desired as the parameter.

## Output Modes (Switcher)

Switcher output channels A and B may have certain specific relationships defined between them, controlled by the three “radio buttons” at the top of the Output section of the Switcher Panel. These three relationships are:

- B independent from A
- B = All outputs driven, A = off
- B = All outputs driven except # selected for A

When **B independent from A** is selected, channels A and B may be independently set to any channel number within their range. This is the normal mode for most operation.

When **B = All outputs driven, A = off** is selected, the switcher B common input is connected to all 12 outputs on each Output switcher module and the A common input is disconnected. Both the A

and B output fields will be gray and unavailable for settings in this mode since all connections are defined by the mode itself. This mode enables connection of a single signal to all device inputs, which may be a requirement of a “burn-in” rack or a life test.

When “**B = all outputs driven except # selected for A**” is selected, the A common input connects to the channel number entered in the A output field. The B common input connects to the remaining 11 channels on that switcher and to all 12 channels of all other Output switchers connected. The purpose of this mode is for “worst-case crosstalk” measurements, so that all channels except one of a multi-track or multi-channel recorder or mixing console are driven while the output signal from the one undriven channel is measured. This mode is normally used with a nested sweep with Source 2 on the Sweep panel set to scan channel A input and output through all possible device channels while Source 1 is commonly set for a frequency sweep to measure selective crosstalk across the audio spectrum.

## Switcher Sweep Offsets

When the switchers are selected as the instrument at Source 1 or Source 2, a number of Parameters are available in which both Channels A and B, or both Input and Output switchers, may be simultaneously swept. These complex switcher sweeps often require that Channel A and Channel B are not connected to the same channel, or that the Input and Output switchers are not connected to the same channel. The two offset fields on the Switcher panel set the relationship between the switcher parameters being swept. Before a sweep starts or after a sweep is completed, the switcher channel selection will be determined only by the Output and Input sections of the Switcher panel.

**Out to In Offset:** this field determines the channel number difference between the Output Switcher and the Input Switcher at any moment during a sweep. For example, if the value “1” is entered in the Out to in Offset field, the Output switcher will always be connected to the next higher channel number than the Input switcher connection (if Input is at 7, Output is at 8, etc.) An Out-to-In Offset of “1” would permit crosstalk measurement scans of a multitrack tape recorder,

measuring the adjacent higher channel. A value of “-1” would permit measurement of the adjacent lower channel during a scan.

**B to A Offset:** this field determines the channel number difference between Channel B and Channel A at any moment during a sweep. An A-to-B Offset of “1” is often used, along with a Step Size of 2, when testing stereo devices which are connected with stereo pairs going to adjacent switcher channels (device 1 L and R to switcher channels 1 and 2, device 2 L and R going to switcher channels 3 and 4, etc.).

## Switcher Control During Sweeps

The switchers may be controlled in a variety of useful ways during a sweep, by selecting the parameters at Source 1 or Source 2 in the Parameter column for the type of sweep desired. The available sweep control parameters and their functions are as follows.

**Ch. A Input:** The Channel A connector on the Input Switchers will be scanned across the range of switcher input connectors specified by the Start and Stop values at the Source settings of the Sweep panel. All other switcher connections will remain as set on the Switcher panel. This is a common selection to check the same audio parameter on a number of single-channel devices in sequence.

**Ch. B Input:** The Channel B connector on the Input Switchers will be scanned across the range of switcher input connectors specified by the Start and Stop values at the Source settings of the Sweep panel. All other switcher connections will remain as set on the Switcher panel.

**Ch. A Output:** The Channel A connector on the Output Switchers will be scanned across the range of switcher output connectors specified by the Start and Stop values at the Source settings of the Sweep panel. All other switcher connections will remain as set on the Switcher panel. This is a common selection to drive the inputs, one at a time, of a number of single-channel devices in sequence.

**Ch. B Output:** The Channel B connector on the Output Switchers will be scanned across the range of switcher output connectors specified by the Start and Stop values at the Source settings

of the Sweep panel. All other switcher connections will remain as set on the Switcher panel.

**Ch. A Input/Output:** The Channel A connector on the Input Switchers and the Channel A connector on the Output Switchers will both be scanned across the range of switcher output connectors specified by the Start and Stop values at the Source settings of the Sweep panel. If the Input/Output Offset field on the Switcher panel is set to a zero value, both input and output switchers will be set to the same connector number at any given moment. If the Input/Output Offset value is not zero, the selected Output channel number will be greater or smaller than the Input channel number by the value of the I/O Offset field and the Input channel number will correspond to the present command from the Sweep panel Source section. For example, if the I/O Offset is set to 1, the Output switcher will be set to the next higher connector number than the Input switcher at any time during a sweep, and the Sweep panel effectively “drives” the Input channel number. All other switcher connections will remain as set on the Switcher panel. This is a common selection, using an I/O Offset value of zero, to perform tests across the channels of a multi-track tape recorder or a number of monaural devices.

**Ch. B Input/Output:** Identical to Ch. A Input/Output, except that it is the Channel B connectors which are swept. All other switcher connections will remain as set on the Switcher panel.

**Ch. A + B Input:** The Channel A and Channel B connectors on the Input switchers will both be scanned across a series of input connectors. If the A/B Offset field on the Switcher panel is set to zero, both channels A and B will connect to the same input connector. If the A/B Offset field is not zero, the Channel B connection will always be to a connector higher or lower in number than the Channel A connection, by the value in the A/B Offset field. For example, if the A/B Offset value is set to -2, the Channel B Input connector will always be connected to the Input connector two steps below where the Channel A connection is. All other switcher connections will remain as set on the Switcher panel. This selection could be used to sequentially monitor the output signals from a group of stereo power amplifiers on a burn-in rack, all of whose inputs are constantly driven. For that application, the A/B Offset value would be set to 1 and the Stepsize

parameter would be 2. Thus, at the first sweep step channel A connects to switcher channel 1 (device number 1 left channel output) and B connects to switcher channel 2 (device number 1 right channel output). At the next sweep step, channel A connects to switcher channel 3 (device number 2 left channel output) and B connects to switcher channel 4 (device number 2 right channel output), etc.

**Ch. A + B Output:** Identical to Ch. A + B Input, except for the Output switchers. All other switcher connections will remain as set on the Switcher panel.

**Ch. A + Ch. B Input/Output:** Both the A and B connections of both Input and Output switchers are swept across the defined sequence of input and output connections. The difference between Channel A and Channel B settings and between Input and Output settings will be as determined by the two Offset fields on the Sweep panel. This is a common selection to test audio parameters of a number of stereo devices such as power amplifiers in sequence. For this application, the Input/Output Offset value would be zero, the A/B Offset value would be 1, and the Step Size parameter would be 2. Thus, at the first step of the sweep, A input and output are connected to switcher channel 1 (device number 1, left channel) and B input and output are connected to switcher channel 2 (device number 1, right channel). At the second step of the sweep, A input and output connect to switcher channel 3 (device number 2, left channel) and B input and output connect to switcher channel 4 (device number 2, right channel), etc.

## Frequency or Amplitude Sweeps on Many Switcher Channels

A common application is to measure some characteristic, such as frequency response or distortion or noise versus frequency, on a number of nominally identical switcher channels. The results can all overlay on the same graph for channel-to-channel comparisons. Any individual channel traces or combinations of traces may be displayed or printed. This type of test is set up as a “nested sweep” with the switcher selected at Source 2 (on the large form of the Sweep panel). To measure frequency response on all 24 tracks of a tape recorder, for example, select Swr as the instrument and A I/O (Channel A, Input and

Output) as the parameter. Enter 1 for the start, 24 for stop, and 1 as the step size. For frequency response, Source 1 would be Analog Generator Frequency and Level A would be plotted at Data 1. When the sweep is started, Source 2 causes the switcher to connect the channel A input and output to channel 1 and frequency is swept between the Source 1 start and stop values. When data at the stop point is measured, Source 2 steps channel A input and output to channel 2 and the Source 1 sweep repeats. This process continues until all 24 tracks have been measured and plotted. The Graph Legend may be used to turn on and off or highlight by color or trace width particular traces of interest.

### Switcher with Multi-Track Recorder

Multi-track recorders can be quickly tested by use of switchers and “nested sweeps” using both Source 2 and Source 1 on the Sweep panel. The diagram shows typical switcher connections to test multi-track recorders. 32 and 48 track recorders would require three each and four each, respectively, of both input and output switchers.

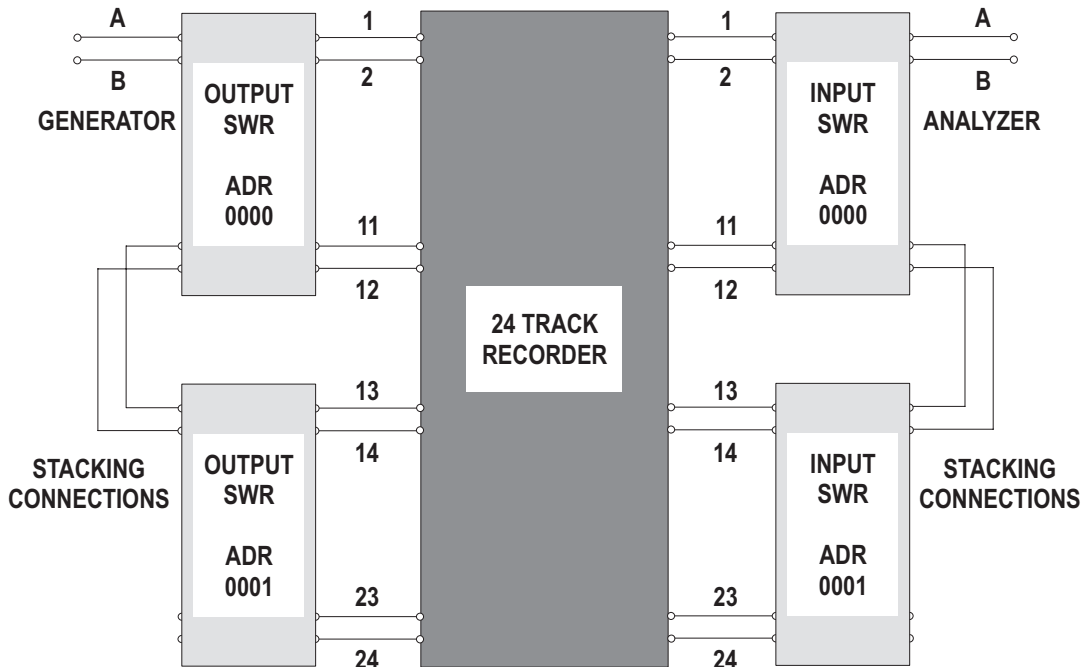

Figure 24-2 Switcher Connection and Address Setting Diagram, Multi-track Recorder



The generator drives the selected recorder input channel via Output switchers and the analyzer selects the output of the same channel via the Input switchers. The second switcher and any others necessary to handle all channels are “stacked” by having their rear panel A and B channels connected in parallel. The “8-4-2-1” rear panel binary address switches must be set to the proper code to make the switchers respond to address 1-12, 13-24, etc., as required.

A typical frequency response measurement across all tracks would be set up with:

- a Level meter connected to analyzer input channel A
- that Level meter then selected at Data 1 on the sweep panel
- a generator frequency sweep set up at Source 1 on the sweep panel
- a switcher channel A input/output “sweep” set up at Source 2 on the sweep panel, starting on switcher channel 1 and stopping at the last channel of the recorder, with a step size of 1

The response curves for all channels would then be overlaid on the same graph and can be compared for level balance, same response shape, etc. The Graph Legend can be used to temporarily turn off unwanted traces or to highlight the trace for a particular channel in a different color or by making the trace thicker.

---

## Switcher Hardware

Audio Precision’s switcher family is designed for use with System One and System Two in the testing of multiple input-output devices such as mixing consoles, multi-track tape recorders, audio routing switchers, distribution amplifiers, or multiple units of simpler units during burn-in, environmental test, and similar activities. The family consists of balanced input, output, and patch-point switchers plus an unbalanced input/output switcher. The patch point switcher permits signal measurements at connection points or allows breaking the normal path, measuring the unloaded output of the previous stage, and driving the following stage with the generator.

## Functional Description

---

The switchers differ from one another primarily in connector configuration and in attributes set by internal jumpers or rear-panel switches which define them as an input switcher (connecting multiple device-under-test outputs to the analyzer inputs), an output switcher (connecting generator outputs to multiple inputs of devices under test), or a patch-point switcher.

Each of the switchers is a balanced 12 x 2 crosspoint matrix. Either of the two common points can be connected, under software control, to any of the twelve selectable points. The circuit boards are of balanced design but may be used with unbalanced circuits with the BNC connector version (floating shells). Up to 16 modules of the input and/or output switcher may be stacked and connected in daisy-chain fashion to permit testing devices with up to 192 inputs and/or outputs (up to 96 stereo pairs). Rear panel programming switches permit setting the address of each module in a stacked-module system for the desired channel number selections 1 through 12, 13 through 24, etc. A simplified diagram of the input and output switchers is shown in Figure 24-3. The relay contacts shown as single switches are actually multiple relay contacts connected in a more complex arrangement. This is necessary to obtain the isolation and crosstalk required for practical professional and high-grade consumer applications.

### Input Switcher

---

The input switchers function basically as the simplified diagram indicates. Any of up to 12 balanced circuit points per module (192 with the maximum 16 modules stacked) may be connected to either the A or B connector, which would in turn normally be connected to the A and B inputs of the analyzer. The balanced version of the input switcher has two male XLR connectors for connection to the analyzer inputs, and 12 female XLR connectors for connection to device-under-test outputs. The unbalanced BNC version may be configured as an input switcher via a rear-panel switch.

### Output Switcher

---

The usual function of the output switcher is to connect System Two generator outputs to a number of device inputs. It is electrically

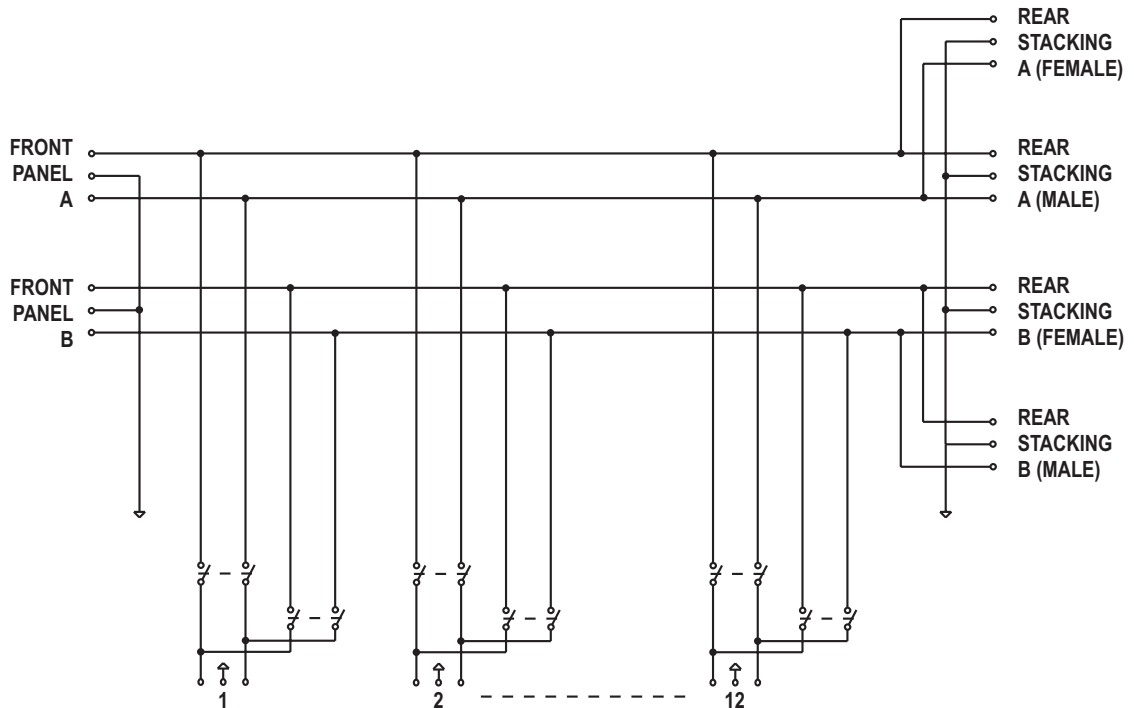

Figure 24-3 Input and Output Switchers, Simplified Functional Diagram

different from the input switcher in that it also has the capability of connecting one output of the generator to all but one input of a device, such as a routing switcher. The output of that one non-driven channel may then be measured to obtain a worst-case crosstalk measurement. The balanced version has two female and 12 male XLR connectors. The unbalanced BNC version may be configured as an output switcher by a rear-panel switch.

### Patch Point Switcher

The patch point switcher differs considerably from the input and output switchers. The two “common” connectors of the patch point switcher are a female connector 3-pin XLR (INPUT) for connection to an output of the generator and a male 3-pin XLR connector (OUTPUT) for connection to an input of the analyzer. The twelve connectors of the patch point version are 5-pin XLR connectors. They are designed for connection at major circuit nodes of a console, or

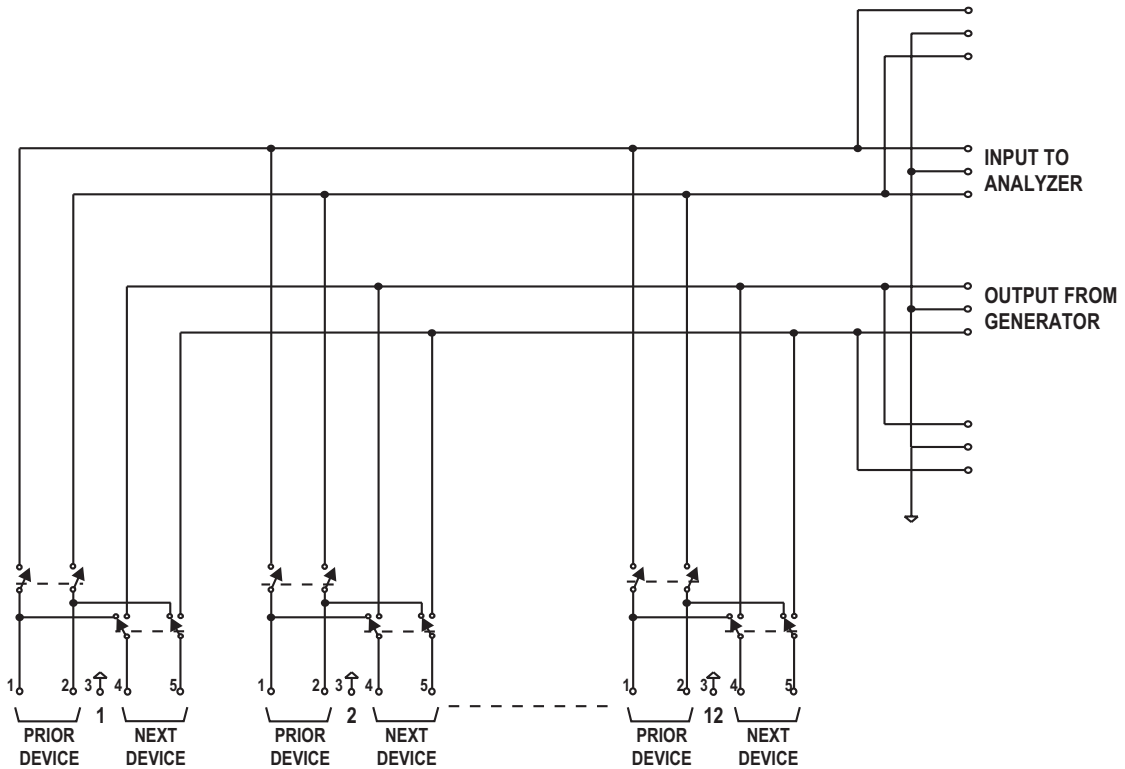

Figure 24-4 Patch Point (Insertion) Switchers, Simplified Functional Diagram

between series-connected devices in an audio chain in a studio, transmitter, or sound reinforcement system. Pins 1 (high) and 2 (low) connect from a balanced output of the preceding device. Pin 3 is ground. Pins 4 (high) and 5 (low) are the signal to a balanced input of the following stage or device. Figure 24-4 is a simplified diagram of the patch-point switcher.

The patch point switcher is “fail safe” in that in its normal mode (power off, or no channel selected) the previous stage or device is directly connected to the input of the following stage or device.

### Switcher Jumper Selection

The switcher circuit board has two jumpers on it labeled P62 and P63. The setting of these jumpers determines whether the switcher

works as an input, output, patch point, or unbalanced switcher. Figure

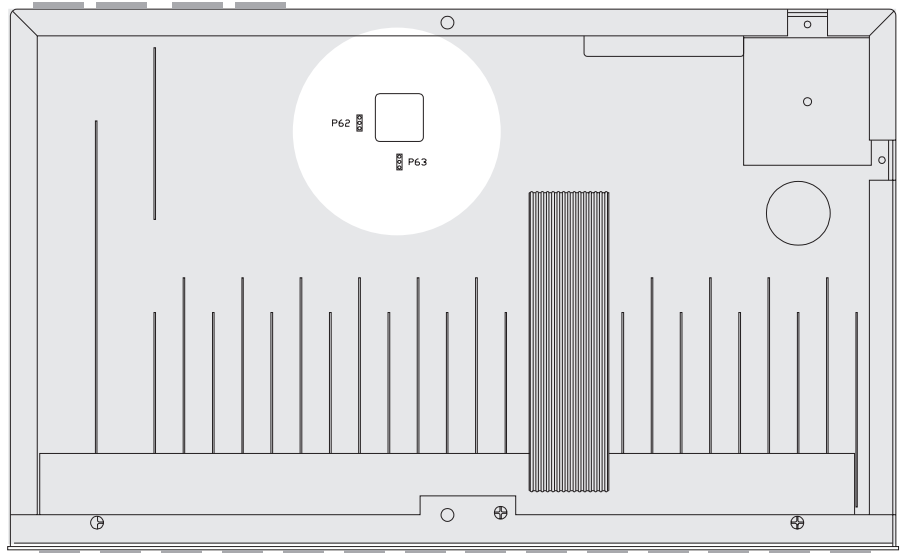

Figure 24-5 P62 and P63 Jumper Locations Inside SWR-2122 Switchers

24-5 shows the overall switcher circuit board with the location of the jumpers. Figure 24-6 shows the settings of the four jumpers for each of the four models of switcher.

### Unbalanced Switcher, Selection of Input vs. Output

The unbalanced switcher uses BNC connectors that may be used for generator output or analyzer input switching. A miniature switch on the rear panel of the switcher accomplishes selection between these two modes.

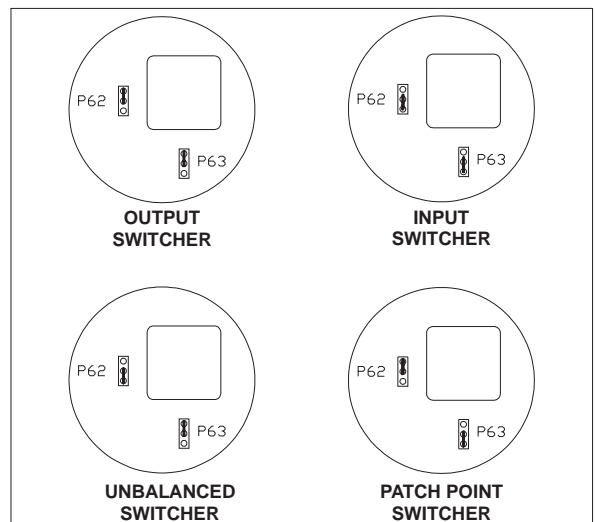

Figure 24-6 P62 and P63 Jumper Placement for Output, Input, Patch Point, and Unbalanced Switchers

When switch 6 (the right-end switch as viewed from the rear) is in the UP position, the unbalanced switcher operates as an input switcher for use with the analyzer. When the switch is in the DOWN position, the unbalanced switcher operates as an output switcher for use with the generator. Note also the labeling on the rear of the unbalanced switcher, describing the difference in cable connections to the four rear-panel BNCs when used as an input versus output switcher.

---

## Switcher Installation

---

Switcher installation consists of physically mounting the switcher modules, setting the ac mains voltage range assembly, providing proper ac mains power, electrically interconnecting them, setting rear panel switches for address, and (on unbalanced switchers only) setting rear panel switch 6 for input or output function. Physically, the switcher modules may be either rack-mounted or simply stacked on top of one another. Ac mains connections are made via standard IEC connectors. A rear panel voltage change and fuse assembly can be set for 100, 120, 220, or 240 Volts AC. No power switch is provided; the units are designed for continuous service.

---

## Switcher Address Settings

---

Each switcher module consists of 12 channels. Up to 16 modules may be stacked to provide up to 192 channels. Rear panel address switches must be set to tell each switcher which channel commands from the software it should respond to. For example, the first switcher is normally set to be channels 1-12, the second module to channels 13-24, etc. The four left-hand switches on the six-switch binary switch bank on the rear panel set the module address. The table below shows relationships between address switch position, binary code, and channel number on the computer software “panels”.

REAR SWITCH SETTINGS				BINARY CODE	CHAN #
#8	#4	#2	#1		
up	up	up	up	0000	1-12
up	up	up	down	0001	13-24
up	up	down	up	0010	25-36
up	up	down	down	0011	37-48
up	down	up	up	0100	49-60
up	down	up	down	0101	61-72
up	down	down	up	0110	73-84
up	down	down	down	0111	85-96
down	up	up	up	1000	97-108
down	up	up	down	1001	109-120
down	up	down	up	1010	121-132
down	up	down	down	1011	133-144
down	down	up	up	1100	145-156
down	down	up	down	1101	157-168
down	down	down	up	1110	169-180
down	down	down	down	1111	181-196

## Cable Connections

Electrically, the digital control connectors of the switchers must be connected in “daisy-chain” fashion. Normally, the computer will be connected to the first switcher with a digital interface cable, the first switcher connects to the second, etc., and the last switcher connects to the System digital interface (APIB) connector. Each switcher has both a male and female digital interface connector on its back panel for these connections.

Audio signal connection must be connected in daisy-chain fashion via the rear panel XLR connectors (balanced) or BNC connectors (unbalanced). Normally, the generator and analyzer outputs and inputs will connect to the front panel inputs and outputs of the first pair of switcher modules (assuming multiple units of both input and output switchers are being used). The rear panel connectors will then be used to connect channels A and B of the first input switcher module to A and B of the next input switcher, etc.

## Patch Point Switchers

Rather than the common channel A and common channel B connector of Input and Output switchers, patch point switchers have a common input and a common output connector. Rear panel switches must be set on a Patch Point switcher to tell it to respond to software commands for Channel A, Channel B, or both. The two right-hand switches on the rear panel binary switch band must be set as shown in the table below to accomplish the desired control.

### REAR SWITCH

A	B	PATCH POINT MODE
down	down	OFF
down	up	CHAN A
up	down	CHAN B
up	up	EITHER A or B

These switches are disabled by the I/O jumper settings in input or output versions of the switcher.

Patch point switchers, input switchers, and output switchers may all be combined in the same system. Input and output switchers may share the same address. A patch point switcher must not have the same address as either an input or output switcher. Two patch point switchers may be set to the same address if one is set as Channel A and the other as Channel B.



# DCX-127 Multifunction Module

## Panel

The primary functions of the DCX-127 include an autoranging 4 1/2 digit volt-ohmmeter, two independent dc voltage outputs variable across the  $\pm 10.5$  Volts range, 21-bit (plus sign bit) low-speed digital inputs and outputs, and three 8-bit digital output ports. The DCX-127 also provides pulses and dc levels whose timing depend upon key software actions such as end of sweep, analyzer channel selection, or data settling. These may be used for synchronization and sequencing of external devices or portions of the test system such as the triggered sine burst generator. See the hardware discussion later in this chapter.

The DCX-127 Multifunction Module is an external accessory which is connected in “daisy chain” fashion to the Audio Precision Interface Bus.

To bring the DCX panel to the screen:

Mouse: Click on the DCX-127 icon  on the toolbar or select Panels DCX via the menu bar

Keyboard: Type    (for Panels DCX-127).

The DCX-127 Panel can be viewed in both large and small versions. Clicking on the panel icon on the Panels Toolbar brings up the small version panel. Holding down the  key while clicking on the toolbar

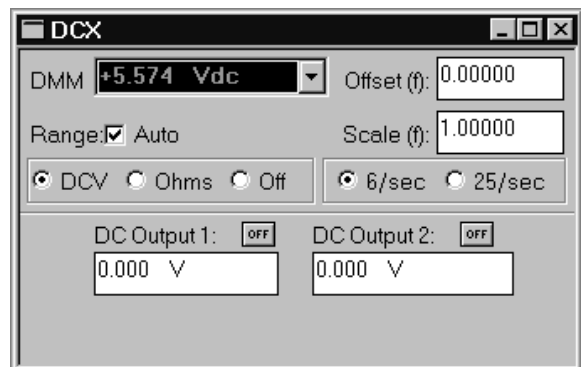

Figure 25-1 DCX-127 Panel, Small Version

icon brings up the large version.

## DMM Units

In DC Volts function, the reading may be displayed either in absolute Volts or as f(V), a function of Volts, after modification by Offset and Scale factors. Similarly, resistance readings may be displayed in Ohms or as f(O) with Offset and Scale. The “available units” list includes only units valid for the presently-selected function (DC or Ohms).

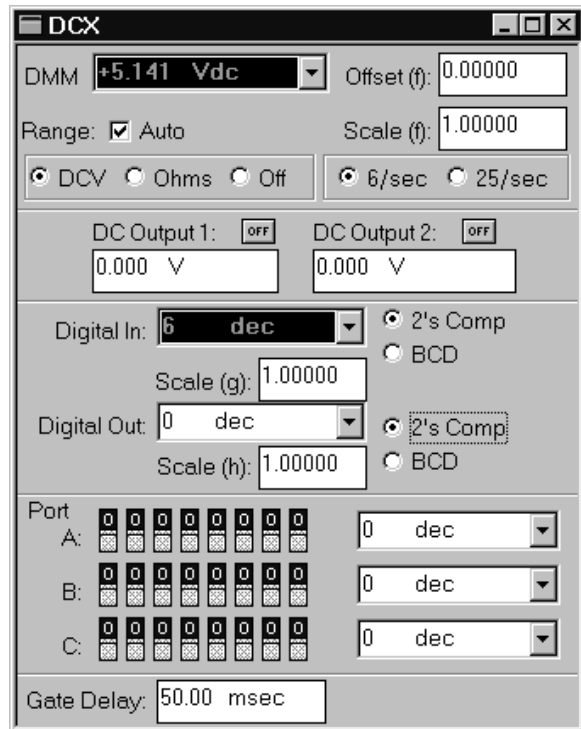

Figure 25-2 DCX-127 Panel, Large Version

## Auto/Fixed Range Checkbox



The Voltmeter/Ohmmeter may operate in autoranging mode or may be fixed on any one of its full-scale ranges.

## Fixed Range Selection Field

When the DMM Autoranging function is disabled (no check mark in Auto box), a Range field is displayed and active for manual range selection. New entries may be typed in or existing entries edited from the keyboard, and completed by pressing



Figure 25-3 Autorange Disabled, Manual Range Entered by User

the  key. When  is pressed, APWIN software will select and display the most-sensitive range which can handle the entered value.

### Offset and Scale Values for f(V), f(O)

---

When f(V) (function of Volts) or f(O) (function of Ohms) units are selected for the DMM, APWIN software computes the value to display from the formula

$$\text{display} = (\text{measurement} + \text{Offset}) * \text{Scale}.$$

The “measurement” term is the value which would be displayed in Volts or Ohms units. The “Offset” and “Scale” values are the contents of the fields with those names, at the top right of the DCX panel. New entries may be typed into either field, or the existing entry edited, from the keyboard followed by pressing the  key.

### DCV/Ohms/Off Selection

---

The DMM (digital multi-meter) can measure DC Volts or Ohms, or be turned off, by use of the three buttons below the Auto Range check box.

### Reading Rate

---

The DMM can operate at 6 or 25 readings per second. Resolution is a full 4 1/2 digits at 6 readings per second. At 25 readings per second, the number of digits displayed is the same but the least significant digit is always 5 or 0.

### DC Output 1 and 2 On/Off

---

Either of the DC outputs (front panel double banana jacks) may be turned on and off individually.

### DC Output 1 and 2 Value

---

Either DC output may be independently set to any voltage in the range  $\pm 10.5$  Vdc. A new value may be entered or the existing value may be edited from the keyboard, followed by the  key.

## Digital Input Display and Units

---

The 21-bit digital input word connected to the DCX front panel DB25 Digital Input connector may be displayed in decimal, hexadecimal, or octal units or as a scaled function  $g(x)$  of the decimal value at the digital input.

## Digital Input Data Format Selection

---

The binary values at the 21 active pints of the Digital Input connector may be interpreted as 2's complement or in 8-4-2-1 BCD (binary coded decimal) format.

## Scale Factor, Digital Input

---

When  $g(x)$  units are selected at the Digital In display, APWIN software computes the displayed value from the relationship

$$\text{display} = \text{measurement} * \text{Scale (g)}$$

where “measurement” is the decimal value of the binary data in the selected format and “Scale (g)” is the value entered in the Scale (g) field just below the Digital In display. A new Scale value may be entered or the present value edited from the keyboard, followed by pressing the  key.

## Digital Output and Units

---

The 21-bit digital output word presented to the DCX front panel DB25 Digital Output connector may be controlled in decimal, hexadecimal, or octal units or as a scaled function  $h(x)$  of the decimal value entered in the Digital Out field.

The value sent to the Digital Output connector, in the unit selected, is determined by the value entered into the Digital Out field but may also be swept from the Sweep Panel.

## Digital Output Data Format

---

The value and units entered in the Digital Out field will be presented to the front panel Digital Output connector in either 2's complement or 8-4-2-1 BCD (binary coded decimal) format.

## Scale Factor for Digital Output

When h(x) units are selected at the Digital Output control field, APWIN software computes the actual transmitted value from the relationship

$$\text{output value} = \text{entry value} * \text{Scale (h)}$$

where “entry value” is the decimal value entered into the Digital Out numeric field and “Scale (h)” is the value entered in the Scale (h) field just below the Digital Out control field. A new Scale value may be entered or the present value edited from the keyboard, followed by pressing the  key.

## Binary Control for Ports A, B, C

Ports A, B, and C are independent 8-bit digital control ports at separate DB9 connectors on the rear of the DCX-127. The settings of the 8 bits may be controlled from the DCX software panel or they may be swept over a range via the Sweep Panel. Settings from the DCX software panel may be made as binary (mouse only), octal, decimal, or hexadecimal numbers. The binary control and display button-indicators are functionally in parallel with the octal-decimal-hexadecimal field. Any change made to the binary buttons is immediately reflected in the octal-decimal-hex field, and vice-versa. To change a value using octal, decimal, or hex units, the desired unit must first be selected (or the present unit accepted). A new value may be entered into the field from the keyboard or the existing value edited, followed by the  key.

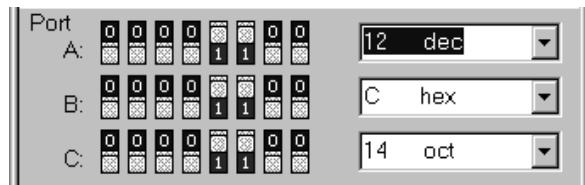

Figure 25-4 Output Ports, Showing Decimal, Hexadecimal, Octal, Binary Controls

## Program Control, Gate Delay

The front-panel Program Control Output DB9 connector provides several pulse or gate signals controlled from APWIN software. Pin 6 on this connector is a sweep gate which goes high at the beginning of

each APWIN sweep and drops low at the end of the sweep. Pin 1 is a delayed sweep gate, similar to pin 6 but with an additional user-settable delay time between sweep start and the leading edge of the gate signal. That delay time is controlled by the Gate Delay field at the bottom of the DCX panel.

### Gate Delay Control for Delayed Trigger

---

The delayed sweep gate (pin 1) is similar to the sweep gate (pin 6) in that it goes low during a sweep and returns high at the completion of the sweep. However, the delayed sweep gate does not go low until the Gate Delay time has elapsed after the beginning of a sweep.

## Hardware Discussion

---

The DCX-127 multi-function module is a separate unit packaged in a one-rack-unit high case which may be rack-mounted or used as a bench instrument. Control of the DCX-127 is via the same APIB (Audio Precision Interface Bus) which controls System One or System Two from the computer. The DCX-127 functions include:

- DC voltage measurement (from the millivolt range to 500 Volts)
- DC resistance measurement (from less than one Ohm to 2 Megohms)
- DC voltage outputs (two independent sources) anywhere in the  $\pm 10.5$  Volt range
- Digital input and display of static or low-speed parallel input, word width up to 21 bits
- Digital output of a parallel digital word of 21 bits
- Program control input of 8 lines which can trigger execution of software macros
- Program control output port which furnishes signals coincident with a number of different software activities such as sweeping, selection of channel A versus channel B input, settling of data during a sweep, etc.

- Digital control outputs (four 8-bit ports) for general-purpose control of external devices.

All the DCX-127 output functions are controlled from APWIN software, and all of the inputs are displayed in APWIN software and may be displayed as bargraphs or plotted values during a sweep when appropriate.

## DC Voltage Measurements

The DCX-127 includes a 4 1/2 digit autoranging dc voltmeter-ohmmeter. In voltage mode, the meter will automatically select among its 200 mV, 2 V, 20 V, 200 V, or 500 V ranges for best resolution of the measured signal. It may also be fixed on any of its ranges. The meter has selectable reading rates of 6 or 25 readings per second. The 6/second selection provides full 4 1/2 digital resolution (20000 counts full scale). The 25/second selection still displays 4 1/2 digits, but the last digit will always be either zero or 5. Normal mode rejection and common mode rejection also degrade by approximately a factor of four when the 25/second reading rate is selected. Resolution versus range and reading rate are shown in the figure.

## Resistance Measurements

The resistance mode operates by forcing a calibrated value of current through the unknown resistance and measuring the consequent voltage drop. The ohmmeter is autoranging and will select either the 200 Ohm, 2 kOhm, 20 kOhm, 200 kOhm, or 2 megOhm range depending on the value of the unknown resistance being measured. It may also be fixed on any range. Reading rates of 6 readings per second or 25 readings per second may be selected. Software features also permit displaying a computed value which is a function of resistance, using user-entered values of offset and scale parameters. The DCX-127 input configuration permits making these resistance measurements on either a 2-wire or 4-wire basis.

### Two-wire connection

If only one pair of test leads is used, connected from the (+) and (-) terminals of the DCX-127 to the unknown resistance, a 2-wire measurement results. Current from the internal current source flows

through an internal resistor, through the test leads and resistance being measured, and through another internal resistor back to the current source. The two internal resistors are indicated schematically on the front panel of the DCX-127. Voltage drop across these internal resistors, produced by this current, is internally measured at the (+) and (-) terminals. The resistance of the two test leads is thus included in the measurement. For moderate and high values of unknown resistance, the additional error introduced by resistance of the test leads is usually negligible.

### Four-wire (Kelvin) connection

For the highest accuracy when measuring low values of resistance, a 4-wire measurement (Kelvin lead connection) is recommended. For this measurement, one pair of test leads is connected from the two current source connectors (marked SOURCE) to the unknown resistance. A second pair of test leads is connected from the voltmeter input terminals (+ and - jacks) to the unknown. Current from the current source now does not flow through the voltmeter leads, so the resistance of the test leads is not included in the measurement.

The resolution of the reading varies with the range and with the reading rate as shown in the figure.

### DC Voltage Outputs

---

Two independent dc voltage outputs are available at the DCX-127 front panel. Each may be set with 20 microvolt resolution (approximately 20 bits equivalent) to any voltage in the  $\pm 10.5000$  Volt range.

Example applications of the dc outputs include sweep control of the gain, offset, or both ports of voltage-controlled amplifiers (VCAs) while measuring their gain, distortion, or noise and plotting those values versus control voltage. The dc output can also be used to control the position of a dc-controlled turntable while measuring polar response patterns of a loudspeaker or microphone. Manually operated test equipment with a dc control port (such as the VCF input of a function generator) may be controlled by the dc outputs. Tape machines with dc-controllable bias oscillators may be connected,



enabling MOL, SOL, sensitivity, and other data to be taken automatically.

The dc outputs may be floated up to 2 Volts away from ground. See Figure 25-5 for the equivalent output circuit of both dc outputs. The maximum current which may be drawn from them is 20 milliamperes. The maximum current which the DC outputs can sink is 10 milliamperes.

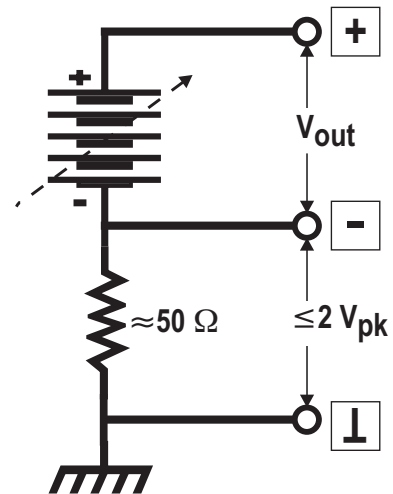

Figure 25-5 Equivalent Circuit, DC Outputs 1 or 2

## Digital Input

A parallel digital word of up to 21 bits plus sign bit, at LSTTL-compatible levels, may be connected to the digital input connector on the front panel of the DCX-127. The value of this word may be displayed in decimal or hexadecimal representations. A user-entered scale factor may be entered and a function of actual input displayed, multiplied by the scale factor. The digital word presented to the connector may be in either two's complement (binary plus a sign bit) or 8-4-2-1 binary coded decimal (BCD) format. The word at the connector may either be asynchronously sampled at any of four different selectable reading rates or, in external mode, displayed each time a "data good" or "conversion completed" pulse is presented at pin 25. The maximum sampling rate depends largely on computer speed. A common application of the digital input is in static (DC) linearity testing of A/D converters. The digital input may also be used to interface readings from a BCD-display instrument such as a capacitance meter to the audio test system. The pin connections are shown in the figure.

## Digital Output

An LSTTL-compatible parallel digital output word of up to 21 bits plus sign may be created at the digital output connector. The value of the word may be entered into the software in either decimal or

hexadecimal representations or scaled decimal. The format of the word (bit-to-pin relationship) may be selected as two's complement or 8-4-2-1 binary coded decimal (BCD). The pin connections are shown in the table. The strobe line (pin 25) will be pulsed low each time a new value is entered into the software panel or stepped to during a sweep.

### Digital I/O Connector Pin Assignments

Pin Number	Function, Two's complement mode	Function, BCD mode
1	Ground	Ground
2	Bit 0 (LSB)	LS digit, 1
3	Bit 1	LS digit, 2
4	Bit 2	LS digit, 4
5	Bit 3	LS digit, 8
6	Bit 4	5th digit, 1
7	Bit 5	5th digit, 2
8	Bit 6	5th digit, 4
9	Bit 7	5th digit, 8
10	Bit 8	4th digit, 1
11	Bit 9	4th digit, 2
12	Bit 10	4th digit, 4
13	Ground	Ground
14	Bit 11	4th digit, 8
15	Bit 12	3rd digit, 1
16	Bit 13	3rd digit, 2
17	Bit 14	3rd digit, 4
18	Bit 15	3rd digit, 8
19	Bit 16	2nd digit, 1
20	Bit 17	2nd digit, 2
21	Bit 18	2nd digit, 4

### Digital I/O Connector Pin Assignments

Pin Number	Function, Two's complement mode	Function, BCD mode
22	Bit 19	2nd digit, 8
23	Bit 20 (LSB)	MS digit, 1
24	Sign	Sign
25	Strobe	Strobe

A typical application of digital output is in static (dc) linearity testing of digital-to-analog converters. The digital output word drives the converter; the analog output of the converter is measured with the DCX-127 DVM. For high-resolution converters at output voltages more than  $\pm 200$  mV away from zero, it will be desirable to use one of the DCX-127 dc outputs in conjunction with the DVM input in differential voltmeter fashion so that the DVM can be set on its highest resolution range. Another application of the digital output is control of digitally-controllable turntables during polar response testing of microphones and loudspeakers. Still another application is in testing multiplying digital-to-analog converters (MDACs) used as variable resistors, attenuators, or in other audio applications. Each bit output has a five milliamperere current drive capability and 390 Ohms output impedance.

### Program Control Outputs

The Program Control Output connector provides six pulse or gate signals controlled by various actions of APWIN software. The pin assignments are shown in the table. All lines are LSTTL compatible.

The Reset output, pin 2, pulses high when the DCX-127 power is turned on and whenever a Util Restore menu command is executed. The Reset output would typically be used to normalize the condition of external logic devices connected to a System One or System Two test station at power up. It may also be invoked in a procedure by inserting a Util Restore command into the procedure.

### Program Control Output Connector

Connector Pin	Function
1	Delayed Sweep Gate
2	Reset
3	Data Acquired
4	Trigger
5	Undefined
6	Sweep Gate
7	Channel A/B
8	Ground
9	Ground

The Data Acquired output, pin 3, pulses high each time that a set of data satisfies the settling algorithm. See the Sweep Settling section for full details on the settling algorithm. This signal could be used, for example, to cause a Compact Disc player to automatically advance to the next track whenever a successful set of measurements is completed on the preceding track. This is useful during an external frequency or external amplitude test across a series of tracks of a test disc.

The Trigger output, pin 4, pulses high at the end of each delay portion of the settling process. Settling delay, in a generator-based sweep, is the time after the generator steps to a new value before the software starts examining data samples to see if they are settled. This signal could be viewed on a dual-trace oscilloscope along with the signal being measured, to verify that the delay has been optimally set to discard “left over” data from the previous generator step when measuring systems such as 3-head tape recorders or satellite paths which have significant time delays. The Trigger output of the DCX-127 could also be connected to the trigger/gate input of the generator when the BUR-GEN module is present. This will synchronize tone bursts in the sine trig mode with the system’s readiness to make a measurement. The Trigger output could also be used to strobe an external device being tested, such as an analog-to-digital converter. This will help insure that the source is stable before the conversion takes place.

The Sweep Gate output, pin 6, drops low at the beginning of a sweep test and goes high at the completion of a test. In a nested sweep, it will go high momentarily at the end of each Source-1 sweep and drop low again for the next Source-1 sweep after the Source-2 parameter is incremented. One example application of the Sweep Gate output is in testing of the attack characteristics of compressors, limiters, and similar audio processors. With the Sweep Gate connected to the trigger/gate input of the generator when the BUR-GEN module is present and the Burst-gated mode is selected, time zero on a time sweep graph and the start of the signal will be synchronized.

The Channel A/B output, pin 7, goes low whenever analog analyzer input channel A is selected and high whenever input channel B is selected. The level at this pin thus indicates which channel is being measured during a stereo sweep.

The Delay Gate output, pin 1, is similar to the Sweep Gate signal but with the addition of a user-settable delay time between the actual beginning of a sweep test and the leading edge of the gate output signal. This delay time is entered at the bottom of the DCX software panel, in the Gate Delay field.

An example application is power amplifier turn-on and turn-off transient (“thump”) testing. The amplifier power could be turned on by the sweep gate and off by the delayed gate. The output of the amplifier may be measured during a time sweep. To allow correct capture of transients, the Level meter should be used along with a fixed input range.

Another example application is to start a tape machine or turntable for run-up time testing. The basic measurement technique is to perform a time sweep while measuring frequency from a pre-recorded tape or disc. Use of the Delayed Sweep Gate to start the recorder or turntable permits the instrument to draw the graph when  is pressed, start the time sweep, and then start the machine at a predetermined time into the sweep when the software is ready to take continuous, rapid measurements.

## Digital Control Output Ports

Three rear-panel 9-pin connectors are provided on the DCX-127 for control of external devices. These output ports are intended for direct interface to LSTTL circuitry, or via LSTTL-compatible drivers to relays. Control of power, lights, annunciators, etc., are among the possible applications. The pin connections of these ports are shown below. The current drive capability of each bit line is five milliamperes; the output impedance is 390 Ohms.

CONNECTOR PIN	FUNCTION
1	bit 7 (msb)
2	bit 6
3	bit 5
4	bit 4
5	bit 3
6	bit 2
7	bit 1
8	bit 0 (lsb)
9	ground

## Furnished Files

### Analog-to-Analog Tests

#### General Information

A standard installation places System Two Cascade analog-to-analog tests in the **C:\APWIN\S2Cascade\A-a** subdirectory.

Generator Output Configuration: All the tests described in this analog-to-analog section are set up using System Two Cascade's balanced floating output configuration, which drives XLR and double-banana output connectors in parallel. If devices with unbalanced inputs are to be tested, the output configuration of each test used should be changed to unbalanced. In unbalanced modes, the

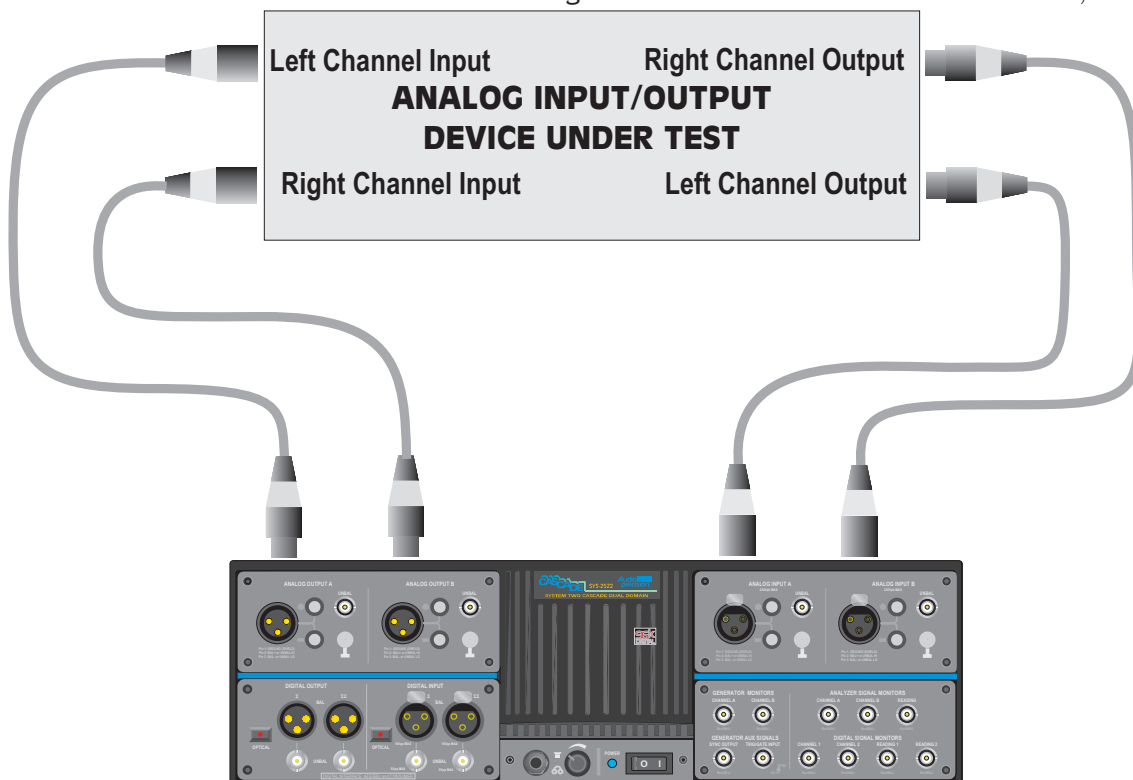

XLR, double banana, or BNC connectors may be used. Floating or grounded configurations may be selected as required by the application. All tests are set up with the 40 Ohm source impedance at Z-Out; one of the other available impedances may be selected as required. Most tests are set up with the generator amplitude at either 0.0 dBu (0.7746 Volts) or 1.000 Volt open circuit. This may be changed to a more appropriate value for any particular device under test in the Amplitude fields for each of the two generator output channels. Some of the tests have the “Track A” box checked at Channel B, which means that the Channel A Amplitude setting controls both channels.

**Analyzer Input Configuration:** All the tests in this analog-to-analog section expect signal from the device under test at the XLR or double banana input connectors. If the BNC connector is to be used, the Source selection of the test must be changed from XLR-Bal to BNC-Unbal. Do not change any GenMon selections.

## Frequency response

---

### **A-a frq resp.at2c**

**Purpose:** This test is set up to measure and graph frequency response on an analog input, analog output device. Mono or stereo devices may be tested, as described below.

**Stimulus:** The Analog Generator is at default conditions (sinewave, 40 Ohms balanced output impedance, 1.000 Volt open circuit amplitude, “resting” frequency before and after sweep of 1 kHz).

**Measurement:** Press the F4 function key to set the dBr A reference value to the present measurement before pressing F9 or clicking Go to start the sweep. This will assure that the response curve passes through zero dBr at the generator resting frequency of 1 kHz. The Level A meter (no filters, RMS detector) makes the measurement and is fully-specified for accuracy only with signal amplitudes of 5 mV and above. Amplitude function of the reading meter should be used if response measurements are required on signal amplitudes below 5 mV.

**Sweep and Display:** The sweep is 30 steps (31 values) logarithmically-spaced from 20 kHz to 20 Hz, sweeping from high to



low. The graph Y axis covers the +/-15 dBr A range. If values on the particular device under test plot off the top or bottom of the graph, use the Optimize function (click right mouse button on graph for a list of graph-related commands).

Stereo: Both generator channels are on but only channel A will be measured and plotted as the test is set up. To test a stereo device, click the Stereo Sweep checkbox at the bottom of the Sweep panel on Page 2. The Level B meter will then simultaneously plot at Data 3. Since both Data 1 and Data 3 share the left axis which is calibrated in dBr A units, the Level B trace will not pass through zero dBr A at 1 kHz if there is a gain difference between the two channels at 1 kHz. If it is desired to have both traces pass through zero at 1 kHz, un-check the Stereo Sweep checkbox, select Level B at Data 2, and select dBr B units for Data 2. The dBr B Reference will have been set to the measured Channel B Level when the F4 key was pressed, so any gain difference between the channels will not be seen and both traces will pass through zero dBr at the analog generator reference frequency.

## Fast Frequency response

### **A-a frq resp fast.at2c**

A DSP-equipped unit (SYS-2422 or SYS-2522) is required for this test.

Purpose: This test is set up to very rapidly (about two seconds) measure and graph frequency response on an analog input, analog output device. Mono or stereo devices may be tested, as described below.

Stimulus: The DSP-generated Sine (D/A) waveform of the Analog Generator is selected. Configuration is at the default condition of 40 Ohms balanced output impedance. Amplitude is 1 Volt, “resting” frequency before and after the sweep is 1 kHz.

Measurement: The Analog Analyzer balanced input circuitry is used with XLR connectors selected. The input ranges are fixed at +40 dBu full scale for fastest operation. The DSP Audio Analyzer program is selected on the Digital Analyzer panel. The HiRes A/D @65536 input selection routes signals from the Analog Analyzer front end to the A/D

converters whose digital outputs drive the DSP Audio Analyzer. The Fast RMS detector and Auto detector reading rate are chosen for maximum measurement speed. The Channel A and B Level meters make the measurement. The wide dynamic range of the DSP Audio Analyzer provides over 80 dB useful dynamic range for response sweeps, which extends from +40 dBu down to -40 dBu at these Analog Analyzer input range settings.

**Sweep and Display:** The sweep is 50 steps (51 values) logarithmically-spaced from 20 kHz to 20 Hz, sweeping from high to low. A complete sweep should about two seconds. Raising the lower frequency limit (Stop) can further increase sweep speed if data down to 20 Hz is not required. The graph Y-axis covers the +/-15 dB<sub>r</sub> A range. If values on the particular device under test plot off the top or bottom of the graph, use the Optimize function (click right mouse button on graph for a list of graph-related commands)

**Stereo:** The test is set up with Level A at Data 1 and the Stereo Sweep box checked, which puts Level B at Data 3. If only one channel is connected, un-check the Stereo box.

## Noise (single point)

---

### **A-a noise.at2c**

**Purpose:** This test is set up to measure noise, integrated across the audio spectrum, on a mono or stereo analog-to-analog audio device. The result is a single number (per channel), not a graph.

**Stimulus:** The Analog Generator output is off, so waveform and amplitude are irrelevant. However, the generator output impedance serves as a defined back termination for the device input if the are connected. The generator output configuration is at default conditions of 40 Ohms impedance, balanced. Other impedances may be required by some noise-measurement specifications.

**Measurement:** The reading meter of the Analog Analyzer is in Amplitude function using the RMS detector. Other detectors may be selected instead; for example, the Q-Pk detector would be used for a CCIR 468 weighted noise measurement. The high and low pass filters are set to the 22 Hz to 22 kHz range. Thus, the measurement will be

limited to noise in the 22 Hz-22 kHz band. Filter selections can be changed to other bandwidths if desired. An appropriate weighting filter (if installed) can be selected in the Filter selection field; for example, the CCIR weighting filter for a CCIR 468 weighted noise measurement.

“Sweep” and Display: A single-point measurement is made (no sweep) and tabular results are displayed in the Data Editor since a graph cannot be made of a single point. The measurement is expressed in dBr A units, which are decibels relative to the value in the Analog Analyzer dBr A Reference field. This value could have been set to the measured level with signal if the generator was turned on and the F4 key pressed, or a known standard reference level can be typed into the dBr A Reference field. Data 1 Top and Bottom values are unimportant since there will be no graph. The reason for selecting Generator Amplitude A as the Source 1 parameter, with 1 nanovolt as the Start value, is merely to create a Column heading and value in column one of the Data Editor which helps indicate that this is a noise measurement (no signal). Since the generator output is turned off on the generator panel, the actual Source 1 parameter and setting is not important.

Stereo: To test a stereo device, click the Stereo Sweep checkbox at the bottom of the Sweep panel. Since the analog analyzer reading meter can only measure one channel at a time, the two channels will be automatically be measured in sequence with results displayed in columns two and three of the Data Editor.

### **THD + N vs. frequency**

---

#### **A-a THD+N vs freq.at2c**

Purpose: This test is set up to measure and graph THD+N (total harmonic distortion plus noise) as a function of stimulus frequency across the audio band on an analog-to-analog audio device. Mono or stereo devices may be tested.

Stimulus: The Analog Generator is at default conditions (sine waveform, 40 Ohms balanced output impedance, 1.000 Volt open circuit amplitude, “resting” frequency before and after sweep of 1 kHz).

**Measurement:** The reading meter of the Analog Analyzer is in THD+N Ratio function with the high and low pass filters set to the 22 Hz to 22 kHz range. Note that the 22 kHz low-pass filter will attenuate second harmonic products from fundamentals above 11 kHz, third harmonics of fundamentals above 7 kHz, etc. If the device under test is not already inherently band-limited in the 20 kHz area, it may be desirable to change the low-pass filter setting to 80 kHz in order to measure harmonics up through the fourth at the 20 kHz end of the sweep range.

**Sweep and Display:** The sweep is 30 steps (31 values) logarithmically-spaced from 20 kHz to 20 Hz, sweeping from high to low. The graph Y axis is logarithmic from 100% at the top to 0.0001% at the bottom, covering virtually all possible measurements. For better display of data after measurement of a particular device, use the Optimize function (click right mouse button on graph for a list of graph-related commands).

**Stereo:** Both generator Channels are on but only Channel A will be swept, measured, and plotted as the test is set up. To test a stereo device, click the Stereo Sweep checkbox at the bottom of the Sweep panel. Since the analog analyzer reading meter can only measure one channel at a time, the stereo sweep will first sweep and plot Channel A, then switch analyzer channels automatically and sweep and plot Channel B onto the same graph. If the THD+N of the device to be measured is not below about -95 dB (0.0014%) and testing speed is an issue, the DSP Audio Analyzer can be used and both channels measured simultaneously in a single sweep. This test is described immediately below as A-a THD+N vs freq 2ch.at2c.

### **THD + N vs. frequency, Simultaneous Two Channels**

#### **A-a THD+N vs freq 2ch.at2c**

A DSP-based (SYS-2422 or SYS-2522) System Two Cascade is required for this test.

**Purpose:** This test is set up to more rapidly measure and graph THD+N (total harmonic distortion plus noise) as a function of stimulus frequency of a stereo (two channel) device. Both channels are measured simultaneously during a single generator sweep.

**Stimulus:** The Analog Generator is at default conditions (sine waveform, 40 Ohms balanced output impedance, 1.000 Volt open circuit amplitude, “resting” frequency before and after sweep of 1 kHz).

**Measurement:** The DSP Audio Analyzer, with HiRes A/D@65536 input, measures Channel A and Channel B in THD+N Ratio function on its two Function Reading meters and plots them as Data 1 and Data 2. The 20 kHz low-pass filter of the DSP analyzer is used, which will attenuate second harmonic products from fundamentals above 10 kHz, third harmonics of fundamentals above 7 kHz, etc. The quantization noise and distortion of the A/D converters will limit residual THD+N to about -103 to -104 dB, depending upon signal amplitude and frequency. Devices whose THD+N is below -95 to -100 dB should be measured with the analog hardware analyzer test A-a THD+N vs freq.at2c described just above.

**Sweep and Display:** The sweep is 30 steps (31 values) logarithmically-spaced from 20 kHz to 20 Hz, sweeping from high to low. The graph Y axis is logarithmic from 100% at the top to 0.001% at the bottom, covering virtually all possible measurements. For better display of data after measurement of a particular device, use the Optimize Together function (click right mouse button on graph for a list of graph-related commands).

**Stereo:** Both generator Channels are on and are simultaneously plotted during a single sweep.

## **THD + N vs. amplitude**

---

### **A-a THD+N vs ampl.at2c**

**Purpose:** This test is set up to measure and graph THD+N (total harmonic distortion plus noise) as a function of stimulus signal amplitude across a wide dynamic range on an analog-to-analog audio device. Mono or stereo devices may be tested.

**Stimulus:** The Analog Generator is at default conditions of sine waveform, 40 Ohms balanced output impedance, frequency 1 kHz, and “resting” open circuit amplitude before and after sweep of 1.000 Volt. The frequency may be changed to any other desired audio

frequency, but it should be recognized that the 22 kHz low pass filter will attenuate higher harmonics.

**Measurement:** The Function Reading meter of the Analog Analyzer is in THD+N Ratio function with the high and low pass filters set to the 22 Hz to 22 kHz range. Note that the 22 kHz low-pass filter will attenuate second harmonic products from fundamentals above 11 kHz, third harmonics of fundamentals above 7 kHz, etc. If the device under test is not already inherently band-limited in the 20 kHz area and if the generator frequency is changed to a value above 7 kHz, it may be desirable to change the low-pass filter setting to 80 kHz in order to measure harmonics properly.

**Sweep and Display:** The sweep is 35 2-dB steps (36 values) from -50 dBV to +20 dBV, sweeping from low to high amplitude. The graph Y axis is logarithmic from 10% at the top to 0.0001% at the bottom, covering the range of most measurements except for hard clipping in the device under test. For better display of data after measurement of a particular device, use the Optimize function (click right mouse button on graph for a list of graph-related commands).

**Stereo:** Both generator Channels are on but only Channel A will be swept, measured, and plotted as the test is set up. To test a stereo device, click the Stereo Sweep checkbox at the bottom of the Sweep panel on Page 2. Since the Track A box is checked on the generator panel, the Channel B generator amplitude will follow the same values as Channel A. Since the reading meter can only measure one channel at a time, the stereo sweep will first sweep and plot Channel A, then switch analyzer channels automatically and sweep and plot Channel B onto the same graph.

## **Spectrum Analysis of Distortion Products After THD + N Notch Filter**

---

### **A-a FFT of THD+N residual.at2c**

**Purpose:** This test makes an FFT spectrum analysis of distortion products and noise following the analog domain THD+N notch filter. Removing the fundamental test tone component with the notch filter guarantees that any distortion products generated in System Two

Cascade's A/D converters are far below noise levels and will not affect the measurement.

**Stimulus:** The analog generator is set at typical default conditions with a 1 kHz sinewave at 1 Volt open circuit from a 40 Ohm balanced source. These settings may be changed as necessary.

**Measurement:** FFT Spectrum Analyzer is used for analysis, with it's Ch 1 input taken from Anlr Rdng Ratio, the notch filter output of the analog hardware analyzer. The notch filter attenuates the fundamental test tone by typically 120 to 140 dB. If THD+N of the device under test is 0.1% or lower, 60 dB of additional gain is switched into the analog analyzer before connection to the A/D converter inputs. This has the effect of pushing the A/D converter distortion products (typically 110 dB or more below full scale) down to 170 dB or more below the fundamental signal, totally removing them as measurement factors. Ch 2 of FFT is set to None. Power (spectrum) averaging of 4 acquisitions and FFTs is selected to reduce the variance of noise in the display.

**Sweep and Display:** The spectrum from zero to 32 kHz is displayed as Data 1.

**Stereo:** As set up, the test measures analog channel A. For a stereo device, check the Stereo Sweep checkbox. The test will then acquire (and average) the Ch 1 (analog analyzer Ch A) signal following the analog notch filter, then automatically switches to FFT Ch 2 (analog analyzer Ch B) and performs another acquisition, FFT, and averaging cycle and plots both on the same graph.

## **SMPTE IMD vs. amplitude**

---

### **A-a SMPTE vs ampl.at2c**

The IMD option is required for this test.

**Purpose:** This test is set up to measure and graph SMPTE or DIN IMD (intermodulation distortion) as a function of stimulus signal amplitude on an analog-to-analog audio device. Mono or stereo devices may be tested.

**Stimulus:** The Analog Generator configuration is at default conditions (40 Ohms balanced output impedance). The SMPTE 4:1 waveform is selected with frequency set to 7 kHz and IM Freq to 60 Hz. This waveform selection generates two sine waves, with the 60 Hz (IM Freq) sinewave amplitude being four times the amplitude of the high frequency sinewave. To test to the German DIN standard, change the main generator frequency from 7 kHz to 8 kHz and the IM Freq from 60 Hz to 250 Hz. The “resting” open circuit amplitude (before and after sweep) is 1.000 Volt sinewave equivalent peak; that is, the peak-to-peak amplitude of the two-tone signal is equal to the peak-to-peak amplitude of a sinewave of 1.000 V rms.

**Measurement:** The Function Reading meter of the Analog Analyzer is in SMPTE function. This function measures the amplitude of demodulated sidebands around the high-frequency “carrier”.

**Sweep and Display:** The sweep is 35 2-dB steps (36 values) from -50 dBV to +20 dBV, sweeping from low to high amplitude. The graph Y axis is logarithmic from 10% at the top to 0.0001% at the bottom, covering most measurements except for hard clipping in the device under test. For better display of data after measurement of a particular device, use the Optimize function (click right mouse button on graph for a list of graph-related commands).

**Stereo:** Both generator Channels are on but only Channel A will be swept, measured, and plotted as the test is set up. To test a stereo device, click the Stereo Sweep checkbox at the bottom of the Sweep panel on Page 2. Since the Track A box is checked on the generator panel, the Channel B generator amplitude will follow the same values as Channel A. Since the reading meter can only measure one channel at a time, the stereo sweep will first sweep and plot Channel A, then switch analyzer channels automatically and sweep and plot Channel B onto the same graph.

## **CCIF IMD vs. amplitude**

---

### **A-a CCIF vs ampl.at2c**

The IMD option is required for this test.



**Purpose:** This test is set up to measure and graph CCIF (also called twin-tone or difference-tone) IMD (intermodulation distortion) as a function of stimulus signal amplitude on an analog-to-analog audio device. Mono or stereo devices may be tested.

**Stimulus:** The Analog Generator configuration is at default conditions (40 Ohms balanced output impedance). The CCIF waveform is selected with frequency set to 13.5 kHz (center frequency of the two-tone pair) and IM Freq (tone pair spacing) to 1.0 kHz. This waveform selection generates two equal-amplitude sine waves, spaced apart in frequency by the IM Freq value and centered at the Frequency value. Thus, the sinewaves will be located at 13.0 kHz and 14.0 kHz. The “resting” open circuit amplitude (before and after sweep) is 1.000 Volt sinewave equivalent peak; that is, the peak-to-peak amplitude of the two-tone signal is equal to the peak-to-peak amplitude of a sinewave of 1.000 V rms.

**Measurement:** The Function Reading meter of the Analog Analyzer is in CCIF function. The System Two Cascade CCIF IM analyzer measures only the amplitude of the difference product ( $f_2 - f_1$ ), which falls at one kHz in this case.

**Sweep and Display:** The sweep is 35 2-dB steps (36 values) from -50 dBV to +20 dBV, sweeping from low to high amplitude. The graph Y axis is logarithmic from 10% at the top to 0.0001% at the bottom, covering most measurements except for hard clipping in the device under test. For better display of data after measurement of a particular device, use the Optimize function (click right mouse button on graph for a list of graph-related commands).

**Stereo:** Both generator Channels are on but only Channel A will be swept, measured, and plotted as the test is set up. To test a stereo device, click the Stereo Sweep checkbox at the bottom of the Sweep panel on Page 2. Since the Track A box is checked on the generator panel, the Channel B generator amplitude will follow the same values as Channel A. Since the analog analyzer Function Reading meter can only measure one channel at a time, the stereo sweep will first sweep and plot Channel A, then switch analyzer channels automatically and sweep and plot Channel B onto the same graph.

## DIM IMD vs. amplitude

### A-a DIM vs ampl.at2c

The IMD option is required for this test.

**Purpose:** This test is set up to measure and graph DIM (dynamic) intermodulation distortion (sometimes also called TIM, or transient IMD) as a function of stimulus signal amplitude on an analog-to-analog audio device. Mono or stereo devices may be tested.

**Stimulus:** The Analog Generator configuration is at default conditions (40 Ohms balanced output impedance). The DIM 30 waveform is selected which generates a 3.15 kHz squarewave and a 15 kHz sinewave with the peak-to-peak amplitude of the squarewave four times that of the sinewave. The “30” connotes that the signal is passed through a 30 kHz low pass filter in the generator. The “resting” open circuit amplitude (before and after sweep) is 1.000 Volt sinewave equivalent peak; that is, the peak-to-peak amplitude of the complex signal is equal to the peak-to-peak amplitude of a sinewave of 1.000 V rms.

**Measurement:** The Function Reading meter of the Analog Analyzer is in DIM function. The System Two Cascade DIM IM analyzer measures the amplitude of the spectrum between 750 Hz and 2.4 kHz, which will include fifth and sixth order intermodulation products of the sinewave and squarewave.

**Sweep and Display:** The sweep is 35 2-dB steps (36 values) from -50 dBV to +20 dBV, sweeping from low to high amplitude. The graph Y axis is logarithmic from 10% at the top to 0.0001% at the bottom, covering most measurements except for hard clipping in the device under test. For better display of data after measurement of a particular device, use the Optimize function (click right mouse button on graph for a list of graph-related commands).

**Stereo:** Both generator Channels are on but only Channel A will be swept, measured, and plotted as the test is set up. To test a stereo device, click the Stereo Sweep checkbox at the bottom of the Sweep panel on Page 2. Since the Track A box is checked on the generator panel, the Channel B generator amplitude will follow the same values

as Channel A. Since the analog analyzer Function Reading meter can only measure one channel at a time, the stereo sweep will first sweep and plot Channel A, then switch analyzer channels automatically and sweep and plot Channel B onto the same graph.

### **Interchannel phase vs. frequency**

---

#### **A-a relative phase.at2c**

**Purpose:** This test is set up to measure and graph interchannel phase difference of an analog-to-analog stereo or other two-channel audio device as a function of frequency.

**Stimulus:** The Analog Generator is at default conditions (sine waveform, 40 Ohms balanced output impedance, 1.000 Volt open circuit amplitude, “resting” frequency before and after sweep of 1 kHz). Both Channels are on.

**Measurement:** The Phase meter measures phase difference between the signals at the two analyzer input connectors. It is fully-specified for accuracy only with signal amplitudes of 5 mV and above on both channels.

**Sweep and Display:** The sweep is 30 steps (31 values) logarithmically-spaced from 20 kHz to 20 Hz, sweeping from high to low. The graph Y axis covers the +/-90 degree range. If values on the particular device under test plot off the top or bottom of the graph, use the Optimize function (click right mouse button on graph for a list of graph-related commands).

**Stereo:** Interchannel phase is intrinsically a measurement made only on stereo or two-channel devices.

### **Input/Output phase**

---

#### **A-a in-out phase.at2c**

**Purpose:** This test is set up to measure and graph input-to-output phase shift of an analog-to-analog audio device.

**Stimulus:** The Analog Generator is at default conditions (sine waveform, 40 Ohms balanced output impedance, 1.000 Volt open

circuit amplitude, “resting” frequency before and after sweep of 1 kHz). Both Channels are on.

Measurement: Channel A of the Analog Analyzer is driven by the front-panel XLR input connector, but Channel B is set to “GenMon” which is an internal cable connection from the Channel B output of the Analog Generator. The Phase meter measures phase difference between the reference signal (generator Channel B output) and the Channel A XLR input, which is thus phase at the output of the device under test relative to the device input. The Phase meter is fully-specified for accuracy only with signal amplitudes of 5 mV and above on both channels.

Sweep and Display: The sweep is 30 steps (31 values) logarithmically-spaced from 20 kHz to 20 Hz, sweeping from high to low. The graph Y axis covers the  $\pm 90$  degree range. If values on the particular device under test plot off the top or bottom of the graph, use the Optimize function (click right mouse button on graph for a list of graph-related commands). If the device under test has a large amount of phase shift (time delay) between input and output, it may be necessary to increase the number of steps, to sweep from low to high, and to use a linear rather than logarithmic sweep in order to avoid phase curve discontinuities due to phase making one or more complete rotations in the frequency interval between two measurements.

Stereo: To make a graph of input-output phase of both channels of a stereo device requires first running this test as set up, then changing the Analog Analyzer Channel A input selection from XLR-Bal to GenMon and Channel B from GenMon to XLR-Bal, then clicking the Append checkbox and running the test again.

## Linearity

---

### **A-a linearity.at2c**

Purpose: This test is set up to measure and graph deviation from perfect input-output linearity of an analog-to-analog mono or stereo audio device.

**Stimulus:** The Analog Generator is at default conditions (sine waveform, 40 Ohms balanced output impedance, frequency 1 kHz, and “resting” open circuit amplitude before and after sweep of 1.000 Volt).

**Measurement:** The reading meter of the Analog Analyzer is in Bandpass function with the Bandpass filter frequency slaved to the Analog Generator frequency via the AGen Track selection of the BP/BR Filter Frequency field. Bandpass function is used to produce a frequency-selective amplitude measurement that rejects noise across most of the spectrum in order to measure the generator signal amplitude accurately even at amplitudes below the wide-band noise level.

**Sweep and Display:** The sweep defined by Source 1 on the Sweep panel consists of 60 steps of two-dB size from -100 dBV to +20 dBV. The intent is to test a typical audio device from near or below its noise level to above its clipping level, and Start and Stop values may be changed as required by a particular device. The reading meter measurements are plotted at Data 1 (and Data 3 if stereo) in dBg A units. This unit expresses the measured value in decibels relative to the present value of generator channel A amplitude. A perfectly linear device will result in a flat horizontal trace across the entire range. A trace at zero dBg A indicates a unity (x1) gain device. Linear performance at any other value of gain or loss is represented by a flat horizontal trace at the gain value of the device. If the device has more than ten dB gain or loss, the trace will go off the graph top or bottom which are set for +/-10 dBg A. Use of the right mouse button Optimize command following the end of a sweep will result in displaying the full range of measurements.

**Stereo:** Both generator Channels are on but only Channel A will be swept, measured, and plotted as the test is set up. To test a stereo device, click the Stereo Sweep checkbox at the bottom of the Sweep panel on Page 2. Since the Track A box is checked on the generator panel, the Channel B generator amplitude will follow the same values as Channel A. Since the reading meter can only measure one channel at a time, the stereo sweep will first sweep and plot Channel A, then switch analyzer channels automatically and sweep and plot Channel B onto the same graph.

## Crosstalk vs. frequency

### A-a xtlk.at2c

**Purpose:** This test measures and graphs crosstalk attenuation or stereo separation from one channel of an analog-to-analog audio device into another channel, as a function of frequency.

**Stimulus:** The Analog Generator is at default conditions (sine waveform, 40 Ohms balanced output impedance, 1.000 Volt open circuit amplitude, “resting” frequency before and after sweep of 1 kHz), but only the Channel A output is on.

**Measurement:** The Function Reading meter of the Analog Analyzer is in Crosstalk function, measuring the signal connected to Analyzer Channel B and expressing it in dB relative to the Level meter reading on Channel A. The analyzer thus measures the relative signal feed-through from channel A into channel B. Crosstalk function uses the reading meter bandpass filter in order to reject wide-band noise and accurately measure low levels of crosstalk signal. The bandpass filter frequency is controlled by the Sweep Track selection in the BP/BR Filter Frequency field. This causes the filter to track the analog generator frequency since that is the Source 1 instrument and parameter.

**Sweep and Display:** The sweep is 30 steps (31 values) logarithmically-spaced from 20 kHz to 20 Hz, sweeping from high to low. The graph Y axis is logarithmic from zero dB at the top to -150 dB at the bottom. For better display of data after measurement of a particular device, use the Optimize function (click right mouse button on graph for a list of graph-related commands).

**Stereo:** This test is set up as a Stereo Sweep by the checkbox at the bottom of the Sweep panel, since crosstalk testing implies a two-channel device. Since a conventional crosstalk or separation measurement requires that only one channel be driven at a time, the stereo sweep will first sweep while driving Channel A and plotting Channel B, then will switch generator and analyzer channels automatically and drive B while plotting A onto the same graph.

## FFT spectrum analysis

### A-a FFT.at2c

DSP versions required (SYS-2422 or SYS-2522)

**Purpose:** This test is set up to sample, acquire, and perform an FFT (Fast Fourier Transform) spectrum analysis on one or two channels of an analog output audio device. Stimulus signal may be supplied by System Two Cascade's generator, but the test may also be used to acquire any audio signal including playback of recordings, broadcast signals, real-time speech or music, etc.

**Stimulus:** There is no intrinsic relation between stimulus and measurement in this test. Signal may be acquired and an FFT performed whether signal is coming from System Two Cascade's generator or from any other source. If the generator signal is to be used, it is at default conditions (sine waveform, 40 Ohms balanced output impedance, 1.000 Volt open circuit amplitude, and 1 kHz frequency) with both Channel A and B outputs on.

**Measurement:** The FFT analyzer program is selected on the digital analyzer panel. Its HiRes A/D converters at a 65.536 kHz sample rate are fed from the two input channels of the Analog Analyzer, following the input ranging circuitry and balanced-to-unbalanced conversion. A 16k sample acquisition and FFT is selected. The selected sample rate of 65.536 kHz produces a measurement bandwidth in excess of 30 kHz.

**"Sweep" and Display:** FFT channels 1 and 2, fed from analog input channels A and B, are set up as Data 1 and Data 3 selections via the Stereo Sweep checkbox. The +20 to -150 dBV graph top and bottom selected will cover the range of most signals. The Optimize command of the right mouse button dialog may be selected to provide better graphical resolution. Source 1 selects frequency domain (spectrum analysis) and plots the zero to 32 kHz range on a linear axis. Smaller portions of this range may be selected by zooming with the mouse or changing the Source 1 Start and Stop values. A logarithmic horizontal axis may be selected if both Start and Stop are positive values.

Stereo: As set up, the test measures both channels simultaneously. If signal is present on only channel 1, the Stereo checkbox may be un-checked or the unused trace may be disabled by clicking the X button in the first column of the graph legend.

## Waveform display

---

### A-a view waveform.at2c

DSP versions required (SYS-2422 or SYS-2522)

Purpose: This test is set up to sample, acquire, and display the waveform of one or two channels of an analog output audio device. Stimulus signal may be supplied by System Two Cascade's analog generator, but the test may also be used to acquire any audio signal including playback of recordings, broadcast signals, real-time speech or music, etc.

Stimulus: There is no intrinsic relation between stimulus and measurement in this test. Signal may be acquired and an FFT performed whether signal is coming from System Two Cascade's analog generator or from any other source. If the generator signal is to be used, it is at default conditions (sine waveform, 40 Ohms balanced output impedance, 1.000 Volt open circuit amplitude, and 1 kHz frequency) with both Channel A and B outputs on.

Measurement: The FFT analyzer program is selected on the digital analyzer panel. Its HiRes A/D converters are fed from the two input channels of the Analog Analyzer, following the input ranging circuitry and balanced-to-unbalanced conversion. The selected sample rate of 65.536 kHz produces a measurement bandwidth in excess of 30 kHz. Greater bandwidths may be achieved with the 131,072 Hz (about 60 kHz BW) or 262,144 Hz (about 120 kHz BW) sample rate selections for the A/D converters. A 512 sample acquisition (FFT field) is selected, resulting in a time duration at the 65,536 Hz rate of  $512/65536$  or 7.8 milliseconds. Longer acquisitions may be selected in the FFT and Acquire fields to acquire longer time durations. Free Run is selected as Trigger Source, so the acquisition will be immediate when GO is clicked or F9 pressed. Other Trigger conditions may be selected



if it is desired to acquire signal only when it reaches a certain amplitude value.

“Sweep” and Display: FFT channels 1 and 2, fed from analog input channels A and B, are set up as Data 1 and Data 2 selections. Presuming a measured signal amplitude around one Volt RMS, the graph top and bottom are set to +6 and -2 Volts at Data 1 and +2 and -6 Volts at Data 2 to separate the two traces in dual-trace oscilloscope fashion. If it is desired to put the two channel traces on top of one another for comparison, Data 1 and Data 2 Top and Bottom values should be the same. The Optimize Together command of the graph right mouse button dialog will accomplish this automatically and will optimize the display for signals of significantly higher or lower amplitude than one Volt RMS. Source 1 selects time domain (oscilloscope mode) and plots the zero to five millisecond range on a linear axis. Smaller portions of this range may be selected by zooming with the mouse or changing the Source 1 Start and Stop values. Viewing more than about 7.8 milliseconds (at the 65.536 kHz rate) will require changing the FFT and/or Acquire length to acquire a longer record. The maximum record length of FFT is 256k samples per channel, which is four seconds at the 65.536 kHz sample rate, two seconds at the 131.072 kHz rate, and one second at the 262.144 kHz rate. Source 1 Start and Stop values may be set anywhere in the range of the acquired signal to view the desired portion of the acquired record. The time span between Start and Stop values may be set as desired and is typically equal to several periods of the signal when viewing a sinewave.

Stereo: As set up, the test measures both channels simultaneously. If signal is present on only one channel, the other trace may be turned off either by selecting “None” instead of the FFT channel at the Data 1 or Data 2 Browser, or by disabling the trace in the first column of the graph legend.

## **External frequency response**

### **X-a frq resp.at2c**

Purpose: This test is set up to measure and graph frequency response of an analog output device when the test signal is not under

APWIN software control, such as during playback of a test tape or disc containing a series of tones. Mono or stereo devices may be tested.

**Stimulus:** This test is set up to measure frequency response from a frequency-stepped series of tones from an external, uncontrollable source such as playback of a tape or disk recording or reception of signal from a distant oscillator. All generator settings are thus irrelevant. The external signal must have a “dwell time” at each frequency step of about 0.5 seconds or more.

**Measurement:** The Level A meter (no filters, standard RMS detector) is the measuring instrument.

**Sweep and Display:** For an external sweep, Source 1 on the Sweep panel is selected as a measurement (the Analog Analyzer Channel A Frequency counter in this case) rather than a setting as is common for most sweeps.

The Start value of 20 Hz and Stop value of 20 kHz indicate that the expected sweep direction will be from low to high; they must be reversed if the actual sweep proceeds from high to low frequency. The values also determine the graph extremes, but measurements will be taken even if the value is outside either extreme and the graph end values may be changed afterwards to display all the data.

The Spacing value of 5% means that a new measurement will be acquired and plotted each time the incoming frequency changes by at least 5% from its previous value. If the frequency steps of the external source are smaller than 5%, the Spacing value should be reduced in order to make measurements at every value.

The Min Lvl (minimum level) value of -60 dBV (one millivolt) causes the plotting to pause if the measured signal level drops below that value, as it may between tracks of a test disk or tape. This value should be set higher than the noise level from the device under test when in-between tracks.

The End On value of 1 kHz will cause the test and plot to be automatically terminated if the external signal goes to a 1 kHz value following its series of frequency steps across the range. If automatic

termination is desired, “End On” it should be set to the frequency value of the tone that follows the last step of the sweep.

Response is plotted using dBr A units. Before pressing F9 or GO, play a mid-band signal such as one kHz from the test tape or disc and press the F4 key to set the dBr reference. The response curve will then go through zero dBr A at the reference frequency.

Stereo: The Analog Analyzer Channel A Level meter reading is plotted at Data 1. If a stereo device is to be tested, check the Stereo Sweep box at the bottom of the Sweep panel. Channel B will then be measured and plotted at Data 3. At each new frequency step of the external signal, both Level A and Level B measurements will be made and plotted simultaneously. Both channels will be plotted in dBr A units, so any absolute level difference between the two stereo channels will be visible on the graph. If you prefer that both curves go through zero dBr at the reference frequency, un-check Stereo Sweep and select the Level B meter at Data 2, with dBr B units.

### **External THD + N vs. frequency**

---

#### **X-a THD+N vs freq.at2c**

Purpose: This test is set up to measure and graph THD+N (total harmonic distortion plus noise) of an analog output device when the test signal is not under APWIN software control, such as during playback of a test tape or disc containing a series of tones. Mono or stereo devices may be tested.

Stimulus: This test is set up to measure from a frequency-stepped series of tones from an external, uncontrollable source such as playback of a tape or disk recording or reception of signal from a distant oscillator. All generator settings are thus irrelevant. The external signal must have a minimum “dwell time” at each frequency step of about 1 to 1.5 seconds minimum if a monaural signal and 2.5 to 3.0 seconds minimum if a two-channel signal.

Measurement: The reading meter of the Analog Analyzer is in THD+N Ratio function with the high and low pass filters set to the 22 Hz to 22 kHz range. Note that the 22 kHz low-pass filter will attenuate second harmonic products from fundamentals above 11 kHz, third

harmonics of fundamentals above 7 kHz, etc. If the device under test is not already inherently band-limited in the 20 kHz area, it may be desirable to change the low-pass filter setting to 80 kHz in order to measure harmonics up through the fourth at the 20 kHz end of the sweep range.

**Sweep and Display:** For an external sweep, Source 1 on the Sweep panel is selected as a measurement (the Analog Analyzer Channel A Frequency counter in this case) rather than a setting.

The Start value of 20 Hz and Stop value of 20 kHz indicate that the expected sweep direction will be from low to high; they must be reversed if the actual sweep proceeds from high to low frequency. The values also determine the graph extremes, but measurements will be taken even if the value is outside either extreme and the graph end values may be changed afterwards to display all the data.

The Spacing value of 5% means that a new measurement will be acquired and plotted each time the incoming frequency changes by at least 5% from its previous value. If the frequency steps of the external source are smaller than 5%, the Spacing value should be reduced in order to make measurements at every value.

The Min Lvl (minimum level) value of -60 dBV (one millivolt) causes plotting to pause if the signal level drops below that value, as it may between tracks of a test disk or tape. This value should be set higher than the noise level from the device under test when in-between tracks.

The End On value of 1 kHz will cause the test and plot to be automatically terminated if the external signal goes to a 1 kHz value following its series of frequency steps across the range. If automatic termination is desired, “End On” should be set to the frequency value of the tone that follows the last step of the sweep.

**Stereo:** The Analog Analyzer THD+N Ratio function is plotted at Data 1. If a stereo device is to be tested, check the Stereo Sweep box. Channel B will then be plotted at Data 3. Since the reading meter can only measure one channel at a time, at each new frequency of the external signal channel A will be measured, input channels switched, channel B measured, and the input switched back to channel A. This

pre-supposes that the dwell time of the external signal at each frequency is long enough to permit settled distortion measurements on each channel in sequence.

### Wow & flutter vs. time

#### A-a W&F vs time.at2c

The Wow & Flutter option is required for this test.

**Purpose:** This test is set up to measure wow and flutter of the signal from a tape or disk player. The test measures wow and flutter for a period of time and graphs it in chart recorder style. At the end of the measurements, the test also computes the “2 sigma” value of all the measurements in order to provide a single number that may be compared to a specification.

**Stimulus:** Wow and flutter measurements should be made while a tape or disk player is reproducing a previously-recorded reference signal, normally either 3.15 kHz or 3.00 kHz. This signal is usually reproduced from a purchased wow and flutter reference tape or disk which was recorded on a high-quality machine maintained and adjusted to have as little wow and flutter as possible. Some people with access to a high-quality recorder prefer to record their own wow and flutter test tapes. For such a case, this test is set up with the Analog Generator in high-accuracy mode, generating a 3.15 kHz sinewave. Actual measurements should not be made while recording, but after rewinding and while playing the recording. Thus, the generator settings are irrelevant when measuring and the generator outputs are typically not connected to the device under test when measuring wow and flutter.

**Measurement:** The Analog Analyzer Function Reading meter in Wow & Flutter function makes the measurement. This test is set up with the NAB detector selection and Weighted measurement selected, but depending upon the standard being followed, the IEC/DIN or JIS detectors may be selected, weighted or unweighted.

**Sweep and Display:** The test is set up to display wow and flutter versus time, as a chart recorder would. A ten second period is plotted. The graph starts at 5 seconds and continues to 15 seconds. Transients

occurring during the first 5 seconds are thus ignored; the wow and flutter detectors have such long time constants that it takes several seconds for the measured value to settle out following the application of a new signal. The stream of measurements from the W&F meter is plotted at both Data 1 and Data 2 in order to use the Compute 2-Sigma function on Data 2 at the end of the test (green trace) without losing the original measurements at Data 1 (yellow trace). At the end of 15 seconds, the Compute 2-Sigma command (Compute Menu) is automatically invoked for Data 2 and the Data 2 measurements are replaced with a single value (horizontal straight line) which is the value which was exceeded by 5% of the readings.

Stereo: Wow and flutter is normally only measured on one channel even if the tape or disk player is stereo, since identical measurements would be expected on either channel.

### Locating -3 dB Point

---

#### **A-a find minus 3 db.at2c**

Purpose: This test is set up to automatically locate the upper or lower minus three dB response point of an analog input-analog output monaural or stereo device, using the Regulation function of APWIN.

Stimulus: The Analog Generator is at default conditions (sinewave, 40 Ohms balanced output impedance, 1.000 Volt open circuit amplitude, “resting” frequency of 1 kHz.

Measurement: Press the F4 function key to set the dBr A reference value to the present measured value at 1 kHz. As stored, the Regulation function has the “-Normal” Operation mode selected. This mode assumes an inverse relationship between the regulated parameter (Analog Analyzer Level A meter amplitude) and the “By Varying” parameter (Analog Generator frequency). An inverse relationship exists at the upper band limit of a device. Press F9 or click on the green light icon on the toolbar and the Regulation function will adjust the generator frequency to the value that produces a -3.0 dBr A measurement, if such a point exists between 1 kHz and 204 kHz. To find the minus three dB point at the lower band limit of a device, change the “Operation” selection to “+Normal” and press F9.

“Sweep” and Display: This test is set up for a single-point “sweep” and therefore produces a tabular display rather than a graph. Column 2 of the Data Editor shows the final amplitude measurement, which should be -3.00 dBr A +/-0.05 dBr. Column 3 shows the measured frequency at that amplitude.

Stereo: As stored, the test will determine the minus 3 dB frequency of the device connected to channel A. To test a stereo device, click on the Stereo Sweep checkbox at the bottom of the Sweep panel. Note, however, that the stereo test will be accurate only if the midband (1 kHz) output level of the device on both channels is equal within an acceptable tolerance, since the dBr A reference value is used for both channels. If device gain and output level is not equal on both channels, they should be tested as if they were two monaural devices.

## **Measuring Power Bandwidth of a Power Amplifier**

### **A-a pwr bndwidth.at2c**

Purpose: This test uses the Regulation function to determine how much power an amplifier can furnish at various frequencies across the audio spectrum, at an acceptable amount of distortion.

Stimulus: The Analog Generator is set to resting values of 1.000 volt amplitude and 1 kHz in frequency, but both amplitude and frequency values will be changed during the course of the test. The generator output configuration is set to Unbalanced Floating 20 ohms impedance since the test was set up with a power amplifier with unbalanced input, but can be changed to Balanced if testing a balanced input device.

Measurement: The Analog Analyzer measures Level (in Watts) and THD+N at the output of the device under test. The Regulation function is set up to vary the generator amplitude as required to achieve a measured distortion value of 0.5% at each step of the sweep. This is accomplished with the “+Normal” selection in the “Operation” field of the Regulation panel. The +Normal selection tells the Regulation function to expect distortion to increase as the generator amplitude increases, which is normal behavior near the clipping point of a device.

**Sweep and Display:** Source 1 sweeps the generator frequency from 200 kHz down to 20 Hz; these values may be changed if they are not appropriate for the device under test. Amplifier output power in watts, measured with the Level A meter, is plotted as Data 1. Note that the watt unit calibration must “know” the actual value of load impedance on the device being tested. The Reference Watts field at the bottom of the Analog Analyzer panel is set to 4.00 ohms as this test was stored and must be changed if another load impedance value is used. Distortion (THD+N) is not plotted (but could be) since it will be a horizontal straight line at 0.5% due to the action of the Regulation function.

**Stereo:** This test is set up for a monaural device connected to Channel A, but could be changed to stereo by clicking the Stereo Sweep checkbox on the Sweep panel.

### **Equalized Response of a Phonograph Preamplifier**

#### **A-a frq resp RIAA.at2c**

**Purpose:** This test is set up to measure the deviation from perfect RIAA equalization of a phonograph preamplifier.

**Stimulus:** The Analog Generator is set to EQ Sine (equalized sinewave) waveform. The selected equalization file is RIAA-PRE.ADQ (located in the C:\APWIN\EQ directory). Resting frequency is 1 kHz and output amplitude is set to 10 mV, a typical value for phono preamplifier input sensitivity. The generator output configuration is set to Unbalanced Float since most phono preamps have unbalanced inputs. Generator output impedance is 20 ohms and both channels are turned on.

**Measurement:** The Level A and Level B meters are plotted at Data 1 and Data 3, in dBr A units. Press the F4 key before starting the sweep, to set the dBr A reference to the measured Channel A amplitude value so the curve will go through zero dBr A at 1 kHz.

**Sweep and Display:** At each step of the sweep, the EQ Sine function and the attached equalization file will change the actual generator output amplitude to follow the shape of the standard RIAA phono preamp preemphasis curve. If the phono preamp under test



has perfect equalization (deemphasis) to the RIAA curve, the result will be a perfectly flat trace. Deviations from flatness of the trace are errors in the preamplifier's equalization curve.

**Mono:** The test is set up as a stereo test since virtually all phono preamplifiers are stereo devices. If a monaural device is to be tested, un-check the Stereo Sweep checkbox at the bottom of the Sweep panel.

## Multitone Test Suite

---

A DSP-equipped unit (SYS-2422 or SYS-2522) is required for all tests in this procedure.

**Purpose:** procedure **A-A MULTITONE.APB** is a complete multitone test suite for an analog input-analog output device. It uses the Multitone Analyzer (FASTTEST) as the Digital Analyzer along with a stereo multitone file selected as the Arbitrary Waveform at the analog generator. It measures frequency response, total distortion, noise, crosstalk (separation), and interchannel phase using multitone technology and saves the results to disk. Unneeded tests may be removed from the procedure. The test files used by A-A MULTITONE.APB are as follows:

- **A-A MULTI FRQ RESP.AT2C** (frequency response, result saved as **RESPONSE.AT2C**)
- **A-A MULTI DISTORTION.AT2C** (total distortion and noise, result saved as **DISTORT.AT2C**)
- **A-A MULTI NOISE.AT2C** (noise, result saved as **NOISE.AT2C**)
- **A-A MULTI XTLK.AT2C** (crosstalk/separation, result saved as **CROSSTALK.AT2C**)
- **A-A MULTI RELATIVE PHASE.AT2C** (interchannel phase, result saved as **PHASE.AT2C**)

**Stimulus:** All five tests are stored with the multitone waveform file **C:\APWIN\WAVEFORM\CASCADE\32 MONO 65K.ags** as the

analog generator Arbitrary Waveform. This file consists of 32 equal-amplitude tones at identical frequencies on both channels A and B, plus six unique tones for crosstalk (separation) measurement on channel A and six other unique tones on channel B. The 32 tones common to both channels are at approximate ISO 1/3-octave band centers from 20 Hz to about 31 kHz. The crosstalk tones, at slightly different frequencies on channels A and B, are positioned at approximate octave spacing from about 560 Hz to about 17.8 kHz. The analog generator output could be turned off on each test file after the first one, since signal is acquired only during the first test.

**Measurement:** The HiRes A/D @65536 input selection routes signals from the Analog Analyzer front end to the A/D converters whose digital outputs drive the Multitone Analyzer (FASTTEST). Output signal from the device under test is acquired only once, when the first test (A-A MULTI FRQ RESP) is loaded. The remaining measurements are made by loading a test with the new setup (distortion, noise, etc.) and using the Re-Process command to re-analyze the signal still in DSP memory. A-A MULTI FRQ RESP uses the Response function of FASTTEST. A-A MULTI DISTORTION uses the Distortion function, A-A MULTI NOISE uses the Noise function, A-A MULTI XTLK uses the Crosstalk function, and A-A MULTI RELATIVE PHASE uses the Spectrum function (required for phase measurements) with the Channel 2 Phase Display field set to Interchannel. The procedure inserts a one-second delay after loading A-A MULTI FRQ RESP to allow time for the analog analyzer autoranging to stabilize on the output level from the device. For optimum speed during repetitive testing of similar devices, the input range of both channels of A-A MULTI FRQ RESP should be fixed on a range that accommodates that signal level; the one-second delay should then be removed from the procedure. This presumes that the output level is known in advance and will be relatively constant from unit to unit.

**Sweep and Display:** The graph horizontal axis is set for 20 Hz-32 kHz logarithmic in all five tests, but Sweep Tables are used to determine the exact frequency values at which data will be transferred from the DSP to the computer. All the tests except A-A MULTI XTLK use

C:\APWIN\WAVEFORM\CASCADE\32 MONO 65K.ads as the Sweep Table. This file lists the exact frequencies of the 32 tones common to both channels (monaural signal). AAMULXTK uses C:\APWIN\WAVEFORM\CASCADE\32 XTLK 65K.ads for a Sweep Table. This file lists six frequencies that are centered on each pair of unique A and B channel crosstalk-measurement tones. With Multitone Analyzer in Crosstalk function, the DSP supplies the amplitude of the nearest unique tone on each channel in response to a query from the computer for data at a particular frequency. Thus, the two curves plotted by A-A MULTI XTLK for A to B and B to A crosstalk are perfectly accurate in amplitude for the actual signals used, but misstate the exact frequencies by a few Hertz to bring them to a central value for plotting.

Stereo: All five tests are set up for stereo devices. To use the four non-phase tests with monaural devices, load each test, select “None” as the Instrument at Data 2, and re-save the test. The phase test requires a two-channel device.

## Analog-to-Digital

### General Information

An SYS-2522 (Dual Domain) unit is required for all tests in this section. A standard installation places System Two Cascade analog-to-digital tests in the **C:\APWIN\S2CASCADE\A-D** subdirectory.

Generator Output Configuration: All the tests described in this analog-to-digital section are set up using System Two Cascade’s balanced floating output configuration, which drives XLR and double-banana output connectors in parallel. If devices with unbalanced inputs are to be tested, the output configuration of each test used should be changed to unbalanced. In unbalanced modes, the XLR, double banana, or BNC connectors may be used. Floating or grounded configurations may be selected as required by the application. All tests are set up with the 40 Ohm source impedance at Z-Out; one of the other available impedances may be selected as required. On most tests, the generator amplitude is set at +20 dBV (10 volts), which was the full-scale amplitude of the particular A/D

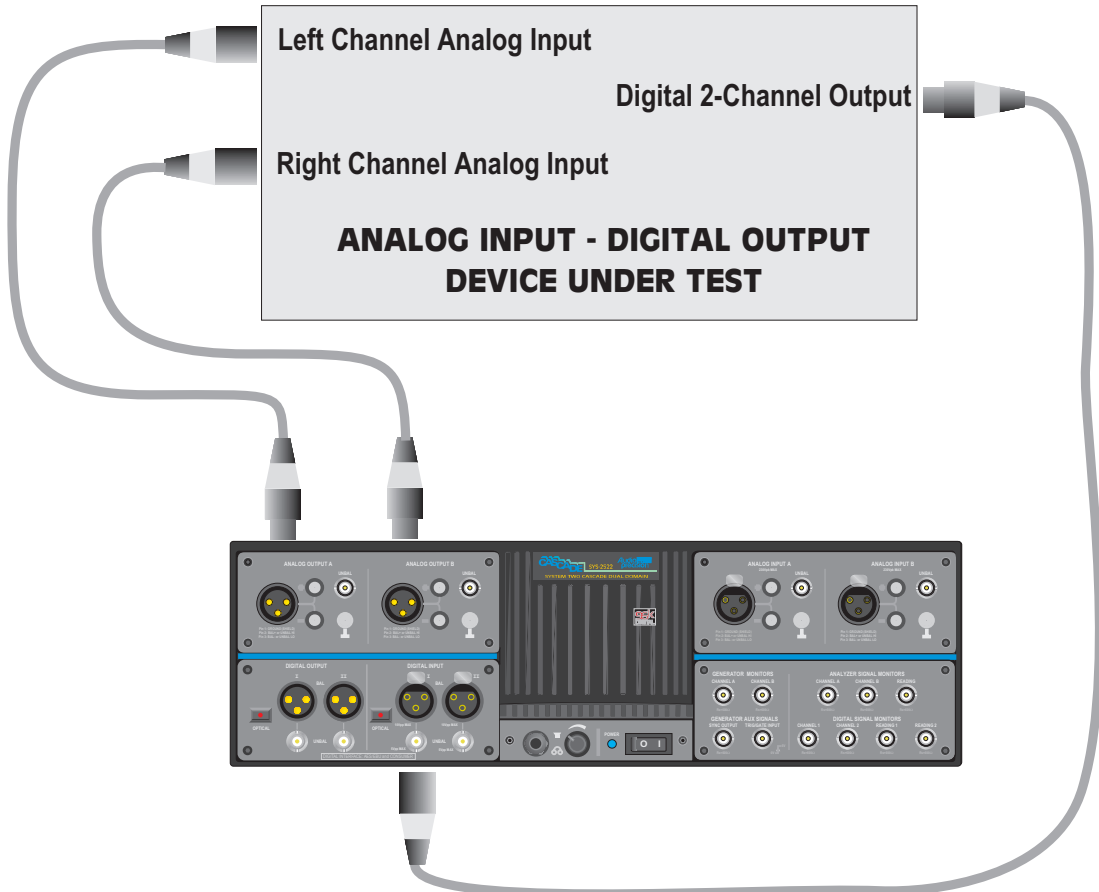

converter used as device under test when the setups were made. It should be changed as necessary to an appropriate value for the device under test.

**Digital Analyzer Input Configuration:** All the tests described in this analog-to-digital section are set up expecting an AES/EBU or SPDIF format (single cable) digital input signal connected to the XLR Digital Input connector. If the device output format is coaxial or optical, the DIO Panel Input Format selection must be changed from XLR (bal) to BNC (unbal) or Optical. If the device uses dual connectors, they should be connected to the Connector I and Connector II inputs and the appropriate Dual input format selection made on the DIO panel. The DIO Panel Input Res. (bits) field should be set to the known word width of the digital input signal. If the word width is unknown, the

Active Bits display of the DIO Panel (large form) should be used to determine the word width.

Audio Frequency Range vs. Sample Rate, Digital Input: All the tests described in this analog-to-digital section are set up with the presumption that the device under test has a sample rate of at least 48 kHz. System Two Cascade automatically locks to and measures the actual digital sample rate. If the device has a lower rate and no changes have been made to the test, some of the tests as provided will fail with an error message of the form “Conflict with maximum DSP setting value while setting XXX (Source 1 parameter) to nnn kHz.” To adapt a test to any specific sample rate, change the upper frequency value at Source 1 on the Sweep Panel from its stored value (typically either 20 kHz or 24 kHz) to a value not greater than  $\frac{1}{2}$  the sample rate. If the device under test operates at a faster sample rate, such as 96 kHz, the upper frequency limit at Source 1 can be changed to a value approaching  $\frac{1}{2}$  the actual sample rate.

## Frequency response

### **A-d Frq resp.at2c**

**Purpose:** This test is set up to measure and graph frequency response on an analog input, digital output device such as an A/D converter. Mono or stereo devices may be tested, as described below

**Stimulus:** The Analog Generator is at default conditions of sinewave, 40 Ohms balanced output impedance, and “resting” frequency before and after sweep of 1 kHz.

**Measurement:** The digital domain level measurement of the channel A digital signal is made by the Level A meter of the DSP Audio Analyzer (ANALYZER). If stereo mode is selected, the channel B digital signal is simultaneously measured by the Level B meter.

**Sweep and Display:** The sweep is 60 steps (61 values) logarithmically-spaced from 22 kHz to 20 Hz, sweeping from high to low. The graph Y axis covers the +2 to -2 dBFS range (dB relative to digital full scale). If values on the particular device under test plot off the bottom of the graph, use the Optimize function (click right mouse button on graph for a list of graph-related commands).

Stereo: The test is stored as a stereo test. To test a monaural device, un-check the Stereo Sweep checkbox at the bottom of the Sweep panel.

## Fast frequency response

---

### **A-d frq resp fast.at2c**

**Purpose:** This test is set up to very rapidly (1-2 seconds) measure and graph frequency response on an analog input, digital output device. Mono or stereo devices may be tested, as described below.

**Stimulus:** The DSP-generated Sine (D/A) waveform of the Analog Generator is selected. Configuration is at the default condition of 40 Ohms balanced output impedance. Amplitude is 3 dB below the nominal full-scale value of the converter under test. The “resting” frequency before and after the sweep is 1 kHz.

**Measurement:** The DSP Audio Analyzer program is selected on the Digital Analyzer panel. The Digital input selection routes signals from the digital connector (XLR as stored) selected on the DIO panel to the DSP Audio Analyzer. The Fast RMS detector is chosen for maximum measurement speed. The Channel A and B Level meters make the measurement.

**Sweep and Display:** The sweep is 50 steps (51 values) logarithmically-spaced from 20 kHz to 20 Hz, sweeping from high to low. A complete sweep should take under two seconds. Raising the Stop frequency can further increase sweep speed if data down to 20 Hz is not required. The graph Y-axis covers the zero to -6 dBFS range. If values on the particular device under test plot off the top or bottom of the graph, use the Optimize function (click right mouse button on graph for a list of graph-related commands)

**Stereo:** The test is set up with Level A at Data 1 and Level B at Data 2. If only one channel is connected, the Instrument selection on the undesired channel should be set to None.

## Noise (single point)

### A-d noise.at2c

**Purpose:** This test is set up to measure noise, integrated across the audio spectrum, on a mono or stereo analog-to-digital audio device such as an A/D converter. The result is a single number (per channel), not a graph.

**Stimulus:** The Analog Generator output is off, so waveform and amplitude are irrelevant. However, the generator output impedance serves as a defined back termination for the device input if they are connected. The generator output configuration is at default conditions of 40 Ohms impedance, balanced. Other impedances may be required by some noise-measurement specifications.

**Measurement:** The Function Reading meters of the Digital Domain Audio Analyzer DSP program are in Amplitude function using RMS detectors. The CCIR quasi-peak detector may be used instead for a CCIR 468 weighted noise measurement, by selecting "4/sec" and "Q-Pk" in the two fields following the Det: label on the digital analyzer panel. The BW limiting filters are set for 22 Hz and 20 kHz. Thus, the measurement will be limited to noise in the primary audio band. Filter selections can be changed to other bandwidths or to a weighting filter if desired via the BW and Fltr fields.

**Sweep and Display:** A single-point measurement is made (no sweep) and tabular results are displayed in the Data Editor since a graph cannot be made of a single point. The reason for selecting Generator Amplitude A as the Source 1 parameter, with a very low value as the Start value, is merely to create a Column heading and value in column one of the Data Editor that helps indicate that this is a noise measurement (no signal). Since the generator output is turned off on the generator panel, the actual Source 1 parameter and setting is not important.

**Stereo:** As set up, both stereo channels will be measured simultaneously. If only a single channel device is to be measured, change the Data 2 selection to None.

## THD + N vs. frequency

---

### A-d THD+N vs freq.at2c

**Purpose:** This test is set up to measure and graph THD+N (total harmonic distortion plus noise) as a function of stimulus frequency across the audio band on an analog-to-digital audio device such as an A/D converter. Mono or stereo devices may be tested.

**Stimulus:** The Analog Generator is at default conditions (sine waveform, 40 Ohms balanced output impedance, “resting” frequency before and after sweep of 1 kHz). The generator amplitude is set to -3 dBr, three dB below the nominal +20 dBV (10 Volts) full scale value of the converter tested when the test was set up.

**Measurement:** The Function Reading meters of the DSP Audio Analyzer DSP are in THD+N Ratio function with the bandwidth limiting filters set to the 10 Hz to 20 kHz range. Both channels are measured simultaneously.

**Sweep and Display:** The sweep is 30 steps (31 values) logarithmically-spaced from 20 kHz to 20 Hz, sweeping from high to low. The graph Y axis is calibrated in dB below signal level, from -70 to -120 dB. For better display of data after measurement of a particular device, use the Optimize function (click right mouse button on graph for a list of graph-related commands).

**Stereo:** The test is set up for stereo devices, measuring both channels simultaneously in a single sweep. If a monaural device is to be tested, change the Data 2 selection to None.

## THD + N vs. amplitude

---

### A-d THD+N vs ampl.at2c

**Purpose:** This test is set up to measure and graph THD+N (total harmonic distortion plus noise) as a function of stimulus signal amplitude across a wide dynamic range on an analog-to-digital audio device such as an A/D converter. Mono or stereo devices may be tested.



**Stimulus:** The Analog Generator is at default conditions of sine waveform, 40 Ohms balanced output impedance, and frequency 1 kHz. The “resting” open circuit amplitude before and after the sweep is set to zero dBr with the dBr Reference set to +20 dBV (10.0 Volts). The frequency may be changed to any other desired audio frequency but results will not be meaningful at stimulus frequencies above 6-7 kHz since third and higher order harmonics will be attenuated by the 20 kHz low-pass filter selection of the analyzer.

**Measurement:** The Function Reading meters of the DSP Audio Analyzer DSP are in THD+N Ampl (absolute amplitude) function with the high and low pass filters set to the 10 Hz to 20 kHz range. Note that the 20 kHz low-pass filter will attenuate second harmonic products from fundamentals above 10 kHz, third harmonics of fundamentals above 6.7 kHz, etc. THD+N Ampl states distortion and noise in absolute terms (% of full scale, dBFS, etc.) rather than relative to the present signal amplitude.

**Sweep and Display:** The sweep is 60 2-dB steps (61 values) from 0 dBr to -120 dBr, sweeping from high to low amplitude. The graph Y axis is calibrated in dBFS (decibels below digital full scale) from -70 to -120 dBFS. An ideal A/D converter will be limited only by the intrinsic quantization distortion and noise due to its resolution (word width), independently of signal level. Therefore, an absolute distortion vs. amplitude curve can be expected to be approximately a horizontal straight line across the graph. For better display of data after measurement of a particular device, use the Optimize function (click right mouse button on graph for a list of graph-related commands).

**Stereo:** The test is set up to measure both stereo channels simultaneously in a single sweep. If a monaural device is to be tested, change Data 2 to None.

### **SMPTE IMD (FFT)**

---

#### **A-d SMPTE FFT.at2c**

**Purpose:** This test is set up to make an FFT (Fast Fourier Transform) spectrum analysis graph with a SMPTE or DIN IMD (intermodulation distortion) test signal on an analog-to-digital audio

device such as an A/D converter. Mono or stereo devices may be tested.

**Stimulus:** The Analog Generator configuration is at default conditions (40 Ohms balanced output impedance). The IMD (D/A) SMPTE 4:1 waveform is selected with High Freq set to 7 kHz and IM Freq to 60 Hz. This waveform selection generates two sine waves, with the 60 Hz (IM Freq) sinewave amplitude being four times the amplitude of the high frequency sinewave. To test to the German DIN standard, change the High Freq value from 7 kHz to 8 kHz and the IM Freq from 60 Hz to 250 Hz. Signal amplitude is calibrated in sinewave equivalent peak; that is, the peak-to-peak amplitude of the two-tone signal is equal to the peak-to-peak amplitude of a sinewave of the stated amplitude.

**Measurement:** The FFT analyzer program is selected on the digital analyzer panel. Digital input is selected, with digital channel A selected as Channel 1 and channel B as Channel 2. A 32k sample acquisition and FFT is selected. The digital input will lock to a wide range of sample rates.

**“Sweep” and Display:** The horizontal axis is set by Source 1 Start and Stop to the audio spectrum between 6.5 kHz and 7.5 kHz. This spectrum includes the 7 kHz “carrier frequency” and intermodulation products (sidebands) up to  $\pm 500$  Hz from the carrier. One graph cursor can be placed on the “carrier” and the second cursor placed on any sideband. The “dy” (difference in y coordinate) display at the graph top will then show the amplitude of each intermodulation distortion product. The 2nd order IMD products will be seen at  $\pm 60$  Hz from the 7 kHz signal, 3rd order IMD products at  $\pm 120$  Hz, etc. If the generator frequency is changed to the German DIN standard 8 kHz/250 Hz frequencies, the Sweep Source 1 Start and Stop frequencies should be changed to display the spectrum between 7 kHz and 9 kHz. In this case, 2nd order sidebands will be at  $\pm 250$  Hz and 3rd order sidebands at  $\pm 500$  Hz from the 8 kHz carrier.

**Stereo:** As set up, the test measures both channels simultaneously. If signal is present on only one channel, the other trace may be turned off either by selecting “None” instead of the FFT channel at the Data 1

or Data 2 Browser, or by disabling the trace in the first column of the graph legend.

## **SMPTE IMD vs Amplitude**

---

### **A-d SMPTE vs ampl.at2c**

**Purpose:** This test provides a measurement of SMPTE (or DIN) IMD on an A/D converter across a wide amplitude range.

**Stimulus:** The Analog Generator, with balanced 40 Ohm output, uses the IMD (D/A) SMPTE/DIN 4:1 waveform with a 60 Hz low frequency and 7 kHz high frequency. To measure to the German DIN standard, change to 250 Hz and 8 kHz. The amplitude is set to 10 Volts peak sinewave equivalent, the nominal full-scale value for the A/D converter under test.

**Measurement:** DSP Audio Analyzer's real-time two-channel SMPTE/DIN analysis function is used. This measures the amplitude of the even and odd order IMD products around the high-frequency "carrier" signal, calibrated relative to the amplitude of the high-frequency tone.

**Sweep and Display:** DSP Audio Analyzer SMPTE/DIN Channel A and B are plotted at Data 1 and Data 3 by checking the Stereo Sweep button. Source 1 is Analog Generator amplitude, swept downwards from nominal converter full scale to a value 50 dB lower in 25 2-dB steps. Since Track A is checked on the generator panel, the generator Channel A and B amplitudes are identical.

**Stereo:** The test is set up for stereo devices. To measure a single-channel device, un-check the Stereo Sweep checkbox.

## **CCIF IMD (FFT)**

---

### **A-d CCIF FFT.at2c**

**Purpose:** This test is set up to make an FFT (Fast Fourier Transform) spectrum analysis graph with a CCIF/DFD (also sometimes called twin-tone or difference tone) IMD (intermodulation distortion)

test signal on an analog-to-digital audio device such as an A/D converter. Mono or stereo devices may be tested.

**Stimulus:** The Analog Generator output configuration is at default conditions (40 Ohms balanced output impedance). The IMD (D/A) CCIF waveform selection on the Analog Generator routes a DSP-generated signal through D/A converters to the analog output stage. Center frequency is set to 13.5 kHz and Difference Freq (tone pair spacing) to 1.0 kHz. This waveform selection generates two equal-amplitude sine waves, spaced apart in frequency by the IM Freq value and centered at the Center Frequency value. Thus, the sinewaves will be located at 13.0 kHz and 14.0 kHz with these settings. Amplitude calibration of the two-tone signal is in terms of sinewave equivalent peak; that is, the peak-to-peak amplitude of the two-tone signal is equal to the peak-to-peak amplitude of a sinewave of 10 V rms.

**Measurement:** The FFT analyzer program is selected on the digital analyzer panel. Digital input is selected, with digital channel A selected as Channel 1 and channel B as Channel 2. A 32k sample acquisition and FFT is selected. The digital input will lock to a wide range of sample rates.

**Sweep and Display:** The horizontal axis is set by Source 1 Start and Stop to the full audio spectrum between zero and 24 kHz. This pre-supposes a 48 kHz or higher sample rate from the A/D unit under test. If the sample rate is lower than 48 kHz, the Source 1 Stop frequency must be changed to a value no higher than  $\frac{1}{2}$  the sample rate. The spectrum displayed will include the test signal tones at 13 kHz and 14 kHz and all intermodulation distortion products falling within the range. The second order IMD product (difference tone) will fall at  $f_2 - f_1$ , or 1 kHz. Third order IMD products fall at  $2f_2 - f_1$  ( $28 - 13 = 15$  kHz) and  $2f_1 - f_2$  ( $26 - 14 = 12$  kHz). One graph cursor can be placed on either of the test tones and the second cursor placed on any IMD product. The “dy” (difference in y coordinate) display at the graph top will then show the amplitude of each intermodulation distortion product.

**Stereo:** As set up, the test measures both channels simultaneously. If signal is present on only one channel, the other trace may be turned

off either by selecting “None” instead of the FFT channel at the Data 1 or Data 2 Browser, or by disabling the trace in the first column of the graph legend.

### **DIM IMD (FFT)**

#### **A-d DIM FFT.at2c**

The IMD option is required for this test.

**Purpose:** This test is set up to make an FFT (Fast Fourier Transform) spectrum analysis graph with a DIM (dynamic intermodulation) test signal on an analog-to-digital audio device such as an A/D converter. Mono or stereo devices may be tested.

**Stimulus:** The Analog Generator configuration is at default conditions (40 Ohms balanced output impedance). The DIM 30 waveform is selected which generates a squarewave at approximately 3.15 kHz and a sinewave at about 15 kHz, with the peak-to-peak amplitude of the squarewave four times that of the sinewave. The “30” connotes that the signal is passed through a 30 kHz low pass filter in the generator. Amplitude calibration of this complex test signal is calibrated in terms of sinewave equivalent peak; that is, the peak-to-peak amplitude of the complex signal is equal to the peak-to-peak amplitude of a sinewave of 10 V rms.

**Measurement:** The FFT Spectrum Analyzer DSP program is selected on the digital analyzer panel. Digital input is selected, with digital channel A selected as Channel 1 and channel B as Channel 2. A 32k sample acquisition and FFT is selected. The digital input will lock to a wide range of sample rates.“

**Sweep and Display:** The horizontal axis is set by Source 1 Start and Stop to the full audio spectrum between zero and 24 kHz. This pre-supposes a 48 kHz or higher sample rate from the A/D unit under test. If the sample rate is lower than 48 kHz, the Source 1 Stop frequency must be changed to a value no higher than  $\frac{1}{2}$  the sample rate. The spectrum displayed will include the test signal sinewave tone at 15 kHz plus the squarewave fundamental frequency at about 3.15 kHz, squarewave third harmonic at about 9.45 kHz, squarewave fifth harmonic at about 15.75 kHz, and squarewave seventh harmonic at

about 22.05 kHz. IMD products may occur at the sum and difference frequencies of all combinations of squarewave fundamental, squarewave harmonics, and 15 kHz tone. The particular IMD products which would be measured on an analog-output device by System Two Cascade's analog IMD analyzer are the fifth order product falling at about 2.4 kHz and the sixth order product falling at about 750 Hz. One graph cursor can be placed on the 15 kHz "probe" tone and the second cursor placed on the IMD product of interest. The "dy" (difference in y coordinate) display at the graph top will then show the amplitude of that intermodulation distortion product.

**Stereo:** As set up, the test measures both channels simultaneously. If signal is present on only one channel, the other trace may be turned off either by selecting "None" instead of the FFT channel at the Data 1 or Data 2 Browser, or by disabling the trace in the first column of the graph legend.

### **Interchannel phase vs. frequency:**

---

#### **A-d relative phase.at2c**

**Purpose:** This test is set up to measure the interchannel phase versus frequency characteristic of an analog input digital output device such as an A/D converter.

**Stimulus:** The Analog Generator provides a sinewave with default output configuration (40 Ohms balanced output impedance).

**Measurement:** Phase function of the Function Reading meter of the DSP Audio Analyzer is selected . Digital input is selected, with digital channel A selected as Channel 1 and channel B as Channel 2. The digital input will lock to a wide range of sample rates."

**Sweep and Display:** Data 1 selects the DSP Audio Analyzer Phase meter for plotting. If the measured phase difference exceeds the  $\pm 15$  degree range at Data 1 Graph Top and Bottom, the Optimize command of the graph right mouse button menu may be used to fit the graph top and bottom to the actual measured data. The analog generator is swept from 20 kHz downwards to 20 Hz in 30 logarithmic steps.

Stereo: Interchannel phase can only be measured on a stereo or other two-channel device.

## Linearity

### A-d linearity.at2c

**Purpose:** This test is set up to measure and graph deviation from perfect input-output linearity of an analog-to-digital mono or stereo audio device such as an A/D converter.

**Stimulus:** The Analog Generator is at default conditions of sine waveform and 40 Ohms balanced output impedance. The frequency is set to 200 Hz. The “resting” open circuit amplitude before and after the sweep is zero dBr, with the dBr Reference set to +20 dBV (10 Volts).

**Measurement:** The DSP Audio Analyzer is selected with the Function Reading meters in Bandpass mode. Sweep Track in the BP/BR Tuning field causes the bandpass filter frequencies to track the frequency of the Sweep Source 1 instrument, which is the analog generator. Bandpass function is used to produce a frequency-selective amplitude measurement that rejects noise across most of the spectrum in order to measure the generator signal amplitude accurately even at amplitudes below the wide-band noise level.

**Sweep and Display:** The sweep defined by Source 1 on the Sweep panel consists of 60 steps (61 measurement points) of two-dB size from 0 dBr to -120 dBr. The intent is to test a typical A/D converter from its maximum input level to below the wideband noise level. Start and Stop values or the Analog Generator dBr Reference value may be changed as required by a particular device. The Channel A bandpass measurements are plotted at both Data 1 and Data 2 in dBFS (decibels relative to digital full scale) units, with the Channel B bandpass plotted at Data 3 and Data 4. The purpose of plotting each channel twice is so that the Compute Linearity function may be used on one trace while still preserving original data on the other. A perfectly linear device will result in a straight diagonal trace across the entire range with the horizontal and vertical coordinates of each point exactly equal. To make it easier to see small deviations from perfect linearity, the Compute Linearity function is set up to automatically execute on the

Data 1 trace following the last point of the sweep. Compute Linearity operates by fitting a best straight line to the data over a range expected to be perfectly linear (-10 dBr to -40 dBr in this case), then subtracts every measurement point from the perfect straight line. The result will be an approximately straight horizontal line near zero dBFS. Use the right mouse button and select the Optimize Individually command following the Compute Linearity operation to automatically select a new right Y-axis graph top and bottom to best displaying the deviation from linearity graph. Most good A/D converters can be expected to be very linear from a few dB below full scale down to approximately the noise level. At some point well below the wideband noise level, the curve can be expected to swing since the analyzer measurement is influenced by noise falling within the bandpass filter range.

Stereo: Both channels are measured (and Compute Linearity applied) in a single sweep. If a single-channel device is being tested, select None at Data 3 and Data 4 (large form of the Sweep panel).

## Crosstalk vs. frequency

---

### A-DXTALK.AT2

Purpose: This test measures and graphs crosstalk attenuation or stereo separation from one channel of an analog-to-digital audio device (such as an A/D converter) into another channel, as a function of frequency.

Stimulus: The Analog Generator is at default conditions of sine waveform, 40 Ohms balanced output impedance, and “resting” frequency before and after the sweep of 1 kHz. Only Channel A is turned on. Note that the proper selection of balanced or unbalanced output, to correspond to the device under test, is particularly critical in crosstalk tests.

Measurement: The Digital Domain Audio Analyzer DSP program (ANALYZER.AZ2) is selected on the Digital Analyzer panel. Digital Channel B is connected to the reading meter of the Digital Domain Analyzer, which is in Crosstalk function. Crosstalk function measures the signal connected to Digital Analyzer Channel B (the non-driven channel) and expresses it in dB relative to the Digital Analyzer Level meter reading on Channel A (the driven channel). The analyzer thus



measures the relative signal feed-through between channels. Crosstalk function uses the bandpass filter in order to reject wide-band noise and accurately measure low levels of crosstalk signal. The bandpass filter frequency is slaved to the Analog Generator frequency by the AGen track selection in the BP/BR Tuning field.

**Sweep and Display:** The sweep is 30 steps (31 values) logarithmically-spaced from 20 kHz to 20 Hz, sweeping from high to low. The graph Y axis extends from -60 dB at the top to -110 dB at the bottom. For better display of data after measurement of a particular device, use the Optimize function (click right mouse button on graph for a list of graph-related commands).

**Stereo:** This test is set up as a Stereo Sweep by the checkbox at the bottom of the Sweep panel, since crosstalk testing implies a two-channel device. Since the reading meter can only measure one channel at a time, the stereo sweep will first sweep while driving Channel A and plotting Channel B, then will switch generator and analyzer channels automatically and drive B while plotting A onto the same graph.

## FFT spectrum analysis

### A-d FFT.at2c

**Purpose:** This test is set up to sample, acquire, and perform an FFT (Fast Fourier Transform) spectrum analysis on one or two channels of a digital output audio device. Stimulus signal may be supplied to analog in-digital out devices such as an A/D converter by System Two Cascade's generator, but the test may also be used to acquire any digital domain audio signal including playback of recordings, broadcast signals, real-time speech or music, etc.

**Stimulus:** There is no intrinsic relation between stimulus and measurement in this test. Signal may be acquired and an FFT performed whether signal is coming from System Two Cascade's generator or from any other source. If the generator signal is to be used, it is at default conditions of sine waveform, 40 Ohms balanced output impedance, and 1 kHz frequency. Both Channel A and B outputs are on.

**Measurement:** The FFT Spectrum Analyzer is selected on the digital analyzer panel. Digital input is selected with Digital Channel A connected to FFT Channel 1 and Digital Channel B connected to Channel 2. A 32k sample acquisition and FFT is selected. The digital analyzer will lock to digital input sample rates over a wide range.

**“Sweep” and Display:** FFT channels 1 and 2, fed from digital input channels A and B, are set up as Data 1 and Data 2 selections. The zero to -150 dBFS (dB relative to digital full scale) graph top and bottom selected will cover the range of most signals. The Optimize command of the right mouse button dialog may be selected to provide better graphical resolution following an acquisition. The Source 1 FFT Freq selection chooses frequency domain (spectrum analysis) mode. The zero and 24 kHz Source 1 Start and Stop values are based on the assumption of a 48 kHz or higher sample rate from the device under test. If the sample rate of the device is lower, the Source 1 Stop value must be changed to a number no greater than  $\frac{1}{2}$  the sample rate. A linear axis is chosen. Smaller portions of this range may be selected by zooming with the mouse or changing the Source 1 Start and Stop values following an acquisition. A logarithmic horizontal axis may be selected if both Start and Stop are positive values.

**Stereo:** As set up, the test measures both channels simultaneously. If signal is present on only one channel, the other trace may be turned off either by selecting “None” instead of the FFT channel at the Data 1 or Data 2 Browser, or by disabling the trace in the first column of the graph legend.

## Waveform display

---

### A-d view waveform

**Purpose:** This test is set up to sample, acquire, and display the waveform of one or two channels of a digital output audio device. Stimulus signal to an analog in-digital out device such as an A/D converter may be supplied by System Two Cascade’s generator, but the test may also be used to acquire any digital audio signal including playback of recordings, broadcast signals, real-time speech or music, etc.

Stimulus: There is no intrinsic relation between stimulus and measurement in this test. Signal may be acquired and an FFT performed whether signal is coming from System Two Cascade's generator or from any other source. If the generator signal is to be used, it is at default conditions of sine waveform, 40 Ohms balanced output impedance, and 1 kHz frequency. Both Channel A and B outputs are on.

Measurement: The FFT Spectrum Analyzer is selected on the digital analyzer panel. Digital input is selected, with digital analyzer Channel 1 fed from Channel A of the digital signal and Channel 2 fed from Channel B. A 512 sample acquisition is selected, more than sufficient for the zero to three millisecond viewing span set at Source 1.

"Sweep" and Display: FFT channels 1 and 2, fed from digital input channels A and B, are set up as Data 1 and Data 2 selections. Note the definition of digital full scale is the **rms** value of a sinewave whose peaks are just touching the most positive and most negative allowable digital codes. A sinewave has a crest factor (peak-to-rms value) of 1.414. Thus, the peaks of a zero dBFS sinewave signal level will touch  $\pm 1.414$  FFS. The Graph Top and Bottom values of +1.5 FFS and -4.5 FFS at Data 1 and +4.5 and -1.5 FFS at Data 2 separate the two traces in dual-trace oscilloscope fashion. If it is desired to put the two channel traces on top of one another for comparison, Data 1 and Data 2 Top and Bottom values should be the same. The Optimize Together command of the graph right mouse button dialog will accomplish this automatically and will optimize the display for signals of significantly lower amplitude than one FFS. Source 1 selects FFT Time to provide time domain (oscilloscope mode) display rather than spectrum analysis. The zero to three millisecond range is selected at Source 1 Start and Stop to display three cycles if the signal is 1.00 kHz. Smaller portions of this range may be selected by zooming with the mouse or changing the Source 1 Start and Stop values. The 512 sample record length chosen at the FFT field (with Track FFT selected in the adjacent field) is approximately 10.66 milliseconds (512 samples/48,000 samples per second) and the Source 1 Start and Stop values may be set anywhere in that range to view the desired portion of the acquired record. Longer acquisition buffers, up to 256k (almost 5.5 seconds at a 48k sample rate) may be selected. The time span between Start and

Stop values may be set as desired and is typically equal to several periods of the signal when viewing a sinewave.

Mono: As set up, the test measures both channels simultaneously. If signal is present on only one channel, the other trace may be turned off either by selecting “None” instead of the FFT channel at the Data 1 or Data 2 Browser, or by disabling the trace in the first column of the graph legend.

## Multitone Test Suite

**ADMULTI.APB, ADMULRES.AT2, ADMULDIS.AT2, ADMULNOI.AT2, ADMULXTK.AT2, ADMULPHA.AT2**

Purpose: procedure **A-D MULTITONE.APB** is a complete multitone test suite for an analog input-digital output device. It uses the Multitone Analyzer (FASTTEST) as the Digital Analyzer along with a stereo multitone file selected as the Arbitrary Waveform at the analog generator. It measures frequency response, total distortion, noise, crosstalk (separation), and interchannel phase using multitone technology and saves the results to disk. Unneeded tests may be removed from the procedure. The test files used by **A-D MULTITONE.APB** are as follows:

- **A-D MULTI FRQ RESP.AT2C** (frequency response, result saved as **RESPONSE.AT2C**)
- **A-D MULTI DISTORTION.AT2C** (total distortion and noise, result saved as **DISTORT.AT2C**)
- **A-D MULTI NOISE.AT2C** (noise, result saved as **NOISE.AT2C**)
- **A-D MULTI XTLK.AT2C** (crosstalk/separation, result saved as **CROSSTALK.AT2C**)
- **A-D MULTI RELATIVE PHASE.AT2C** (interchannel phase, result saved as **PHASE.AT2C**)

Stimulus: All five tests are stored with the multitone waveform file **C:\APWIN\WAVEFORM\8k48k.ags** as the analog generator

**Arbitrary Waveform.** This file consists of 30 equal-amplitude tones at identical frequencies on both channels A and B, plus six unique tones for crosstalk (separation) measurement on channel A and six other unique tones on channel B. The 30 tones common to both channels are at approximate ISO 1/3-octave band centers from 23 Hz to 20 kHz. The crosstalk tones, at slightly different frequencies on channels A and B, are approximately positioned at octave spacing from about 550 Hz to about 17 kHz. The Analog Generator D/A Sample Rate is selected as ISR, the Input Sample Rate measurement from the DIO panel. This selection guarantees that the generated multitone waveform will be exactly synchronous with the incoming digital signal from the A/D converter. The analog generator output could be turned off on each test file after the first one, since signal is acquired only during the first test.

**Measurement:** The Digital input selection routes signal from the digital input connector (XLR as stored) selected on the DIO panel to the Multitone Analyzer (FASTTEST). The Synchronous Processing mode of the Multitone Analyzer is used, since the ISR selection as D/A converter sample rate guarantees that the generated and received signals will be synchronous. Output signal from the device under test is acquired only once, when the first test (A-D MULTI FRQ RESP) is loaded. The remaining measurements are made by loading a test with the new setup (distortion, noise, etc.) and using the Re-Process command (Ctrl-F6) to re-analyze the signal still in DSP memory. A-D MULTI FRQ RESP uses the Response function of FASTTEST. A-D MULTI DISTORTION uses the Distortion function, A-D MULTI NOISE uses the Noise function, A-D MULTI XTLK uses the Crosstalk function, and A-D MULTI RELATIVE PHASE uses the Spectrum function (required for phase measurements) with the Channel 2 Phase Display field set to Interchannel.

**Sweep and Display:** The graph horizontal axis is set for 20 Hz-20 kHz logarithmic in all five tests, but Sweep Tables are used to determine the exact frequency values at which data will be transferred from the DSP to the computer. All the tests except A-D MULTI XTLK use C:\APWIN\WAVEFORM\8kmono.ads as the Sweep Table. This file lists the exact frequencies of the 30 tones common to both channels (monaural signal).

A-D MULTI XTLK uses C:\APWIN\WAVEFORM\8k\_xtlk.ads for a Sweep Table. This file lists six frequencies that are approximately centered between each pair of unique A and B channel tones. With Multitone Analyzer in Crosstalk function, the DSP supplies the amplitude of the nearest unique tone on each channel in response to a query from the computer for data at a particular frequency. Thus, the two curves plotted by A-D MULTI XTLK for A to B and B to A crosstalk are perfectly accurate in amplitude for the actual signals used, but misstate the exact frequencies by a few percent to bring them to a central value for plotting.

Stereo: All five tests are set up for stereo devices. To use the tests with monaural devices, load each test, select “None” as the Instrument at Data 2, and re-save the test.

## Digital-to-Analog

### General Information

An SYS-2522 (Dual Domain) unit is required for all tests in this section. A standard installation places System Two Cascade digital-to-analog tests in the C:\APWIN\S2CASCADE\D-A subdirectory.

Generator: All the tests described in this digital-to-analog section use System Two Cascade’s digital generator. This generator drives the XLR Bal, BNC Unbal, and Optical digital output connectors simultaneously. However, the actual interface signal output voltage (or optical signal amplitude, in the case of optical) at a connector will correspond to the Output Voltage setting field on the DIO Panel only for the connector selected in the Output Format field. Thus, Output Format should be changed from BNC (unbal) to XLR (bal) or Optical if the device under test is driven from the XLR or Optical connector instead of the BNC. Most tests in this section are set up with the Output Resolution field of the DIO Panel set to 18 bits since they were set up with an 18-bit D/A converter as the device under test. The Output Resolution field determines at which bit level (word width) the internally-generated 24-bit signal is rounded, with dither (if enabled) added at the appropriate amplitude for a signal of that resolution. It is

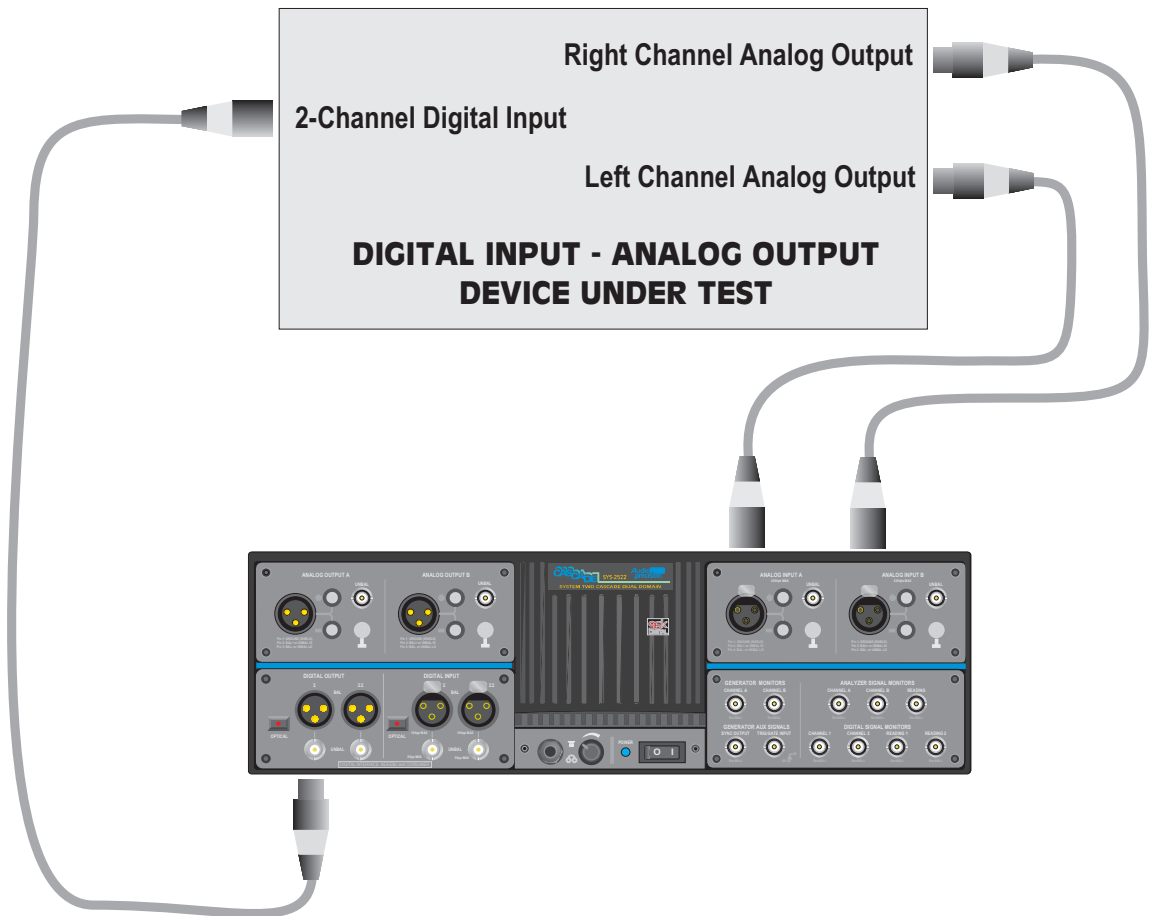

important to change the Output Resolution value to the known input resolution of the D/A device under test; this is particularly critical when tests are made of the low-amplitude performance of the device such as linearity and noise. All tests are set up with Triangular dither enabled, but Rectangular or Shaped dither or no dither may be selected on the Digital Generator panel.

Sample Rate, Digital Output: All the tests described in this digital-to-analog section are set up with the presumption that the device under test is to be tested at a 48 kHz sample rate controlled from System Two Cascade's internal crystal. To test at a different rate, enter the desired rate at the Output Rate (OSR) field on the DIO panel.

If a rate lower than 48 kHz is chosen and no changes have been made to the tests in this section as provided, many of them will fail with an error message of the form “Conflict with maximum DSP setting value while setting XXX (Source 1 parameter) to nnn kHz.” To adapt a test to any specific sample rate, change the upper frequency value at Source 1 on the Sweep Panel from its stored value (typically either 20 kHz or 24 kHz) to a value not greater than  $\frac{1}{2}$  the actual sample rate.

**Status Bits:** All tests in this section are set up to transmit status bits in the Professional format with sample rate and emphasis not indicated on both channels (hex code of 01 00 00 00 for bytes 0-3). Many digital input devices, particularly digital recorders, will not accept a digital input unless the status bits on the digital signal correspond to what the digital product designer thought was appropriate. If the device under test requires other status bits in order to function as desired, the Status Bits panel should be used to set the desired output. This panel may be displayed by clicking on the Status Bits button at the lower right of the large form of the DIO panel, by clicking on the STAT BIT icon on the toolbar, or via the Panels Status Bits menu command. The Professional/Consumer selection is almost always important, and it may also be important that the transmitted Sample Frequency information in the status bits matches the actual Sample Rate being generated by System Two Cascade. The Sample Frequency information in the status bits is not automatically set when System Two Cascade sample rate is changed. When Consumer format is selected, most digital recorders will not accept digital input signal unless Non-Copyright is selected.

**Analog Analyzer Input Configuration:** All the tests described in this digital-to-analog section are set up with the Analog Analyzer BNC unbalanced Channel A and B input connectors since the D/A converter under test at setup time had unbalanced outputs. The XLR or double banana input connectors (hard-wired in parallel with the XLR connectors) may be selected and used instead if appropriate. All tests are set up with a high (100 kilohms) input impedance, but either 600 or 300 Ohms terminating impedance may be selected individually for Channels A and B by fields at the top of the full-size version of the Analog Analyzer panel.



## Frequency response

### D-a frq resp.at2c

**Purpose:** This test is set up to measure and graph frequency response on a digital input, analog output device such as a D/A converter. Mono or stereo devices may be tested, as described below.

**Stimulus:** The Digital Generator is set to an Amplitude of 1.000 FFS (fraction of full scale) on both channels A and B, with both turned on. The “resting” frequency before and after the sweep is 1 kHz.

**Measurement:** The Analog Analyzer Level A meter (no filters, RMS detector) makes the measurement and is fully-specified for accuracy only with signal amplitudes of 5 mV and above. Amplitude function of the reading meter should be used if response measurements are required on signal amplitudes below 5 mV.

**Sweep and Display:** The sweep is 50 steps (51 values) logarithmically-spaced from 22.56 kHz to 10 Hz, sweeping from high to low. The graph Y axis covers the  $\pm 5$  dBrA range. The dBr A unit is a relative unit and the dBr A Reference value will be automatically set to the presently-measured Channel A Level value when the F4 function key is pressed. Since the “resting” frequency of the digital generator is 1 kHz, pressing F4 before pressing F9 or clicking Go will assure that the response curve goes through zero dBr A at 1 kHz. If values on the particular device under test plot off the top or bottom of the graph, use the Optimize function (click right mouse button on graph for a list of graph-related commands).

**Stereo:** Both generator channels are on but only channel A will be measured and plotted as the test is set up. To test a stereo device, click the Stereo Sweep checkbox at the bottom of the Sweep panel. The Level B meter will then simultaneously plot at Data 3. Since both Data 1 and Data 3 share the left axis which is calibrated in dBr A units, the Level B trace will not pass through zero dBr A at 1 kHz if there is a gain difference between the two channels at 1 kHz. If it is desired to have both traces pass through zero at 1 kHz, un-check the Stereo Sweep checkbox, select Level B at Data 2, and select dBr B units for Data 2. The dBr B Reference will have been set to the measured

Channel B Level when the F4 key was pressed, so any gain difference between the channels will not be seen and both traces will pass through zero dBr at the digital generator reference frequency.

## Fast Frequency response

---

### D-a frq resp fast.att2c

**Purpose:** This test is set up to very rapidly (1-2 seconds) measure and graph frequency response on a digital input, analog output device. Mono or stereo devices may be tested, as described below.

**Stimulus:** The Sine waveform of the Digital Generator is selected. Amplitude is 0.0 dBFS. Resting frequency before and after the sweep is 1 kHz.

**Measurement:** The Analog Analyzer unbalanced input circuitry is used with BNC connectors selected. The DSP Audio Analyzer program is selected on the Digital Analyzer panel. The HiRes A/D @65536 input selection routes signals from the Analog Analyzer front end to the A/D converters whose digital outputs drive the DSP Audio Analyzer. The Fast RMS detector is chosen for maximum measurement speed. The Channel A and B Level meters make the measurement.

**Sweep and Display:** The sweep is 50 steps (51 values) logarithmically-spaced from 22.56 kHz to 10 Hz, sweeping from high to low. A complete sweep should take about two seconds. Raising the Stop frequency can further increase sweep speed if data down to 10 Hz is not required. The graph Y-axis covers the +5 dBr A to -5 dBr A range. If values on the particular device under test plot off the top or bottom of the graph, use the Optimize function (click right mouse button on graph for a list of graph-related commands)

**Stereo:** The test is set up as a single channel test. To test a stereo device, click the Stereo Sweep checkbox. Both channels will be plotted in a single sweep.

## Noise (single point)

### D-a noise.at2c

**Purpose:** This test is set up to measure noise, integrated across the audio spectrum, on a mono or stereo digital-to-analog audio device such as a D/A converter. The result is a single number (per channel), not a graph.

**Stimulus:** The Digital Generator output is turned off. If it is desired to establish a reference level before the noise measurement in order to express the result as signal-to-noise ratio, the generator output should be turned on and the F4 key pressed to set the Analog Analyzer dBr A (and dBr B) Reference field to the measured level. In this case, the generator must then be turned off again before pressing F9 or clicking Go to obtain the noise measurement.

**Measurement:** : The Function Reading meter of the Analog Analyzer is in Amplitude function using the RMS detector. Other detectors may be selected instead; for example, the Q-Pk detector would be used for a CCIR 468 weighted noise measurement. The high and low pass filters are set to the 22 Hz to 22 kHz range. Thus, the measurement will be limited to noise in the 22 Hz-22 kHz band. Filter selections can be changed to other bandwidths if desired. An appropriate weighting filter (if installed) can be selected in the Filter selection field; for example, the CCIR weighting filter for a CCIR 468 weighted noise measurement.

**"Sweep" and Display:** A single-point measurement is made (no sweep) and tabular results are displayed in the Data Editor since a graph cannot be made of a single point. The reason for selecting DGen Amplitude A as the Source 1 parameter, with -999 dBFS as the Start value, is merely to create a Column heading and value in column one of the Data Editor which helps indicate that this is a noise measurement (no signal). Since the generator output is turned off on the generator panel, the actual Source 1 parameter and setting is not important. The measurement is expressed in dBr A units, which are decibels relative to the value in the Analog Analyzer dBr A Reference field. This value could have been set to the measured level with signal if the generator was turned on and the F4 key pressed as described

above, or a known standard reference level can be typed into the dB Reference field.

**Stereo:** To test a stereo device, click the Stereo Sweep checkbox at the bottom of the Sweep panel on Page 2. Since the reading meter can only measure one channel at a time, the two channels will be automatically be measured in sequence with results displayed in columns two and three of the Data Editor.

## THD + N vs. frequency

---

### D-a THD+N vs freq.at2c

**Purpose:** This test is set up to measure and graph THD+N (total harmonic distortion plus noise) as a function of stimulus frequency across the audio band on a digital-to-analog audio device such as a D/A converter. Mono or stereo devices may be tested.

**Stimulus:** The Digital Generator is set to an Amplitude of 1.000 FFS (fraction of full scale) on both channels A and B, with both turned on. The “resting” frequency before and after the sweep is 1 kHz.

**Measurement:** The reading meter of the Analog Analyzer is in THD+N Ratio function with the high and low pass filters set to the 22 Hz to 22 kHz range. Note that the 22 kHz low-pass filter will attenuate second harmonic products from fundamentals above 11 kHz, third harmonics of fundamentals above 7 kHz, etc. The intrinsic band-limiting of the digital device at  $\frac{1}{2}$  the sample rate also eliminates higher-frequency harmonics. However, the test is still useful at high stimulus frequencies since it is sensitive to alias (folding) products.

**Sweep and Display:** The sweep is 30 steps (31 values) logarithmically-spaced from 20 kHz to 20 Hz, sweeping from high to low. The graph Y axis covers from -70 dB to -120 dB. For better display of data after measurement of a particular device, use the Optimize function (click right mouse button on graph for a list of graph-related commands).

**Stereo:** Both generator Channels are on but only Channel A will be swept, measured, and plotted as the test is set up. To test a stereo device, click the Stereo Sweep checkbox at the bottom of the Sweep

panel on Page 2. Since the reading meter can only measure one channel at a time, the stereo sweep will first sweep and plot Channel A, then switch analyzer channels automatically and sweep and plot Channel B onto the same graph.

### **THD + N vs. frequency, Simultaneous Two Channels**

#### **D-a THD+N vs freq 2ch.at2c**

**Purpose:** This test is set up to more rapidly measure and graph THD+N (total harmonic distortion plus noise) as a function of stimulus frequency of a stereo (two channel) digital input-analog output device. Both channels are measured simultaneously during a single generator sweep.

**Stimulus:** The Digital Generator is set to an Amplitude of 1.000 FFS (fraction of full scale) on both channels A and B, with both turned on. The “resting” frequency before and after the sweep is 1 kHz.

**Measurement:** The dual Function Reading meters of DSP Audio Analyzer are used in this test. DSP Audio Analyzer, via the HiRes A/D @65536, measures analog signals from the input connectors and ranging circuitry of the Analog (hardware) Analyzer. The high and low pass filters of DSP Audio Analyzer are set to the 22 Hz to 20 kHz range. Note that the quantization noise and distortion of the A/D converters will limit residual THD+N in this test to about -103 dB, while the hardware-measured residual THD+N (see previous test) will be between -108 dB and -115 dB depending upon signal amplitude and frequency. If distortion of the device under test is approximately -95 dB (0.0015%) or higher, the difference in residual distortion of the two analyzers should not be noticeable.

**Sweep and Display:** The sweep is 30 steps (31 values) logarithmically-spaced from 20 kHz to 20 Hz, sweeping from high to low. The graph Y axis is logarithmic from -70 dB at the top to -120 dB at the bottom, covering the likely range of performance of good converters. For better display of data after measurement of a particular device, use the Optimize Together function (click right mouse button on graph for a list of graph-related commands).

**Stereo:** The test is set up as a stereo test.

## THD + N vs. amplitude

### D-a THD+N vs ampl.at2c

**Purpose:** This test is set up to measure and graph THD+N (total harmonic distortion plus noise) as a function of stimulus signal amplitude across a wide dynamic range on a digital-to-analog audio device such as a D/A converter. Mono or stereo devices may be tested.

**Stimulus:** The Digital Generator is set to a “resting” Amplitude of 1.000 FFS (fraction of full scale) before and after the sweep. Both channels A and B are turned on. The frequency is 1 kHz. The frequency may be changed to any other desired value, but it should be recognized that the band-limited nature of the digital device plus the analyzer 22 kHz low-pass filter will attenuate high-frequency harmonics.

**Measurement:** The reading meter of the Analog Analyzer is in THD+N Amplitude function. THD+N Amplitude expresses the integrated distortion and noise measurement in absolute units rather than relative to the present amplitude of the fundamental signal. The high and low pass filters are set to the 22 Hz to 22 kHz range. Note that the 22 kHz low-pass filter will attenuate second harmonic products from fundamentals above 11 kHz, third harmonics of fundamentals above 7 kHz, etc.

**Sweep and Display:** The sweep is 60 2-dB steps (61 values) from 0 dBFS to -120 dBFS, sweeping from low to high amplitude. The graph Y axis is calibrated from -70 dBr A to -110 dBr A. The F4 key should be pressed while the generator output is at 1.000 FFS, before pressing F9 or clicking Go for the sweep. The F4 key causes the present Level A reading (full-scale output level of the D/A converter under test) to be written into the dBr A Reference field. Distortion and noise measurements are thus expressed in dB below full scale. An ideal D/A converter would show a flat horizontal line across the graph, with its quantization distortion and noise level independent of signal level. For better display of data after measurement of a particular device, use the Optimize function (click right mouse button on graph for a list of graph-related commands).

Stereo: Both generator Channels are on but only Channel A will be swept, measured, and plotted as the test is set up. To test a stereo device, click the Stereo Sweep checkbox at the bottom of the Sweep panel on Page 2. Since the Track A box is checked on the generator panel, the Channel B generator amplitude will follow the same values as Channel A. Since the reading meter can only measure one channel at a time, the stereo sweep will first sweep and plot Channel A, then switch analyzer channels automatically and sweep and plot Channel B onto the same graph.

## **Spectrum Analysis of Distortion Products After THD + N Notch Filter**

### **D-a FFT of THD+N residual.at2c**

**Purpose:** This test makes an FFT spectrum analysis of distortion products and noise following the analog domain THD+N notch filter. Removing the fundamental test tone component with the notch filter guarantees that any distortion products generated in System Two Cascade's A/D converters are far below noise levels and will not affect the measurement.

**Stimulus:** The digital generator is set at typical default conditions with a 1 kHz sinewave at 1.00 FFS. These settings may be changed as necessary.

**Measurement:** FFT Spectrum Analyzer is used for analysis, with its Ch 1 input taken from Anlr Rdng Ratio, the notch filter output of the analog hardware analyzer. The notch filter attenuates the fundamental test tone by typically 120 to 140 dB. If THD+N of the device under test is 0.1% or lower, 60 dB of additional gain is switched into the analog analyzer before connection to the A/D converter inputs. This has the effect of pushing the A/D converter distortion products (typically 110 dB or more below full scale) down to 170 dB or more below the fundamental signal, totally removing them as measurement factors. Ch 2 of FFT is set to None. Power (spectrum) averaging of 4 acquisitions and FFTs is selected to reduce the variance of noise in the display.

**Sweep and Display:** The spectrum from zero to 32 kHz is displayed as Data 1.

**Stereo:** As set up, the test measures analog channel A. For a stereo device, check the Stereo Sweep checkbox. The test will then acquire (and average) the Ch 1 (analog analyzer Ch A) signal following the analog notch filter, then automatically switches to FFT Ch 2 (analog analyzer Ch B) and performs another acquisition, FFT, and averaging cycle and plots both on the same graph.

## **SMPTE IMD vs. amplitude**

---

### **D-a SMPTE vs ampl.at2c**

The IMD option is required for this test.

**Purpose:** This test is set up to measure and graph SMPTE or DIN IMD (intermodulation distortion) as a function of stimulus signal amplitude on a digital-to-analog audio device such as a D/A converter. Mono or stereo devices may be tested.

**Stimulus:** The Digital Generator is set to a “resting” Amplitude of 1.000 FFS (fraction of full scale) before and after the sweep. Both channels A and B are turned on. The waveform selected is IMD SMPTE 4:1 with a high frequency sinewave at 7 kHz and low frequency sinewave at 60 Hz. To test to the German DIN standard, the high frequency should be changed to 8 kHz and the low-frequency to 250 Hz. Other test frequencies or the 1:1 Amplitude Ratio may be used. The Analog SMPTE IMD analyzer will function properly with high frequency signals from 3 kHz to the upper band limit of the D/A under test, low-frequency signals from 40 Hz to 500 Hz, and Amplitude Ratios from 1:1 (both sinewaves the same amplitude) to 8:1 (high frequency sinewave 1/8 the amplitude of the low frequency sinewave).

**Measurement:** The Function Reading meter of the Analog Analyzer is in SMPTE/DIN function. This function measures the amplitude of demodulated sidebands around the high-frequency “carrier”.

**Sweep and Display:** The sweep is 30 2-dB steps (31 values) from 0 dBFS to -60 dBFS, sweeping from low to high amplitude. The graph Y



axis is from -20 dB to -110 dB. For better display of data after measurement of a particular device, use the Optimize function (click right mouse button on graph for a list of graph-related commands).

**Stereo:** Both generator Channels are on but only Channel A will be swept, measured, and plotted as the test is set up. To test a stereo device, click the Stereo Sweep checkbox at the bottom of the Sweep panel on Page 2. Since the Track A box is checked on the generator panel, the Channel B generator amplitude will follow the same values as Channel A. Since the reading meter can only measure one channel at a time, the stereo sweep will first sweep and plot Channel A, then switch analyzer channels automatically and sweep and plot Channel B onto the same graph.

## CCIF IMD vs. amplitude

---

### D-a CCIF-DFD vs ampl.at2c

The IMD option is required for this test.

**Purpose:** This test is set up to measure and graph DFD (also sometimes called CCIF, twin-tone, or difference-tone) IMD (intermodulation distortion) as a function of stimulus signal amplitude on a digital-to-analog audio device such as a D/A converter. Mono or stereo devices may be tested.

**Stimulus:** The Digital Generator is set to a “resting” Amplitude of 1.000 FFS (fraction of full scale) before and after the sweep. Both channels A and B are turned on. The waveform selected is IMD CCIF/DFD. The settings of 13.5 kHz Center Frequency and 1.00 kHz difference frequency produce two equal-amplitude sinewaves spaced by the difference frequency value around the center frequency value. Thus, the sinewaves will be at 13.0 kHz and 14.0 kHz with the settings stored in the test. Other frequencies may be used. The Analog IMD Analyzer is compatible with center frequency values from 4 kHz up to the upper band limit of the device under test and difference frequency values from 80 Hz to 1 kHz.

**Measurement:** The reading meter of the Analog Analyzer is in DFD function. The System Two Cascade DFD and CCIF IM analyzer measures only the amplitude of the difference product ( $f_2 - f_1$ ), which

falls at one kHz in this case. The difference between the DFD standard and the CCIF standard is a 6.02 dB calibration difference; DFD reads 6.02 dB lower than CCIF for any actual level of distortion products and noise.

**Sweep and Display:** The sweep is 30 2-dB steps (31 values) from 0 dBFS to -60 dBFS, sweeping from high to low amplitude. At very low analyzer input levels or with noisy signals, the analyzer frequency counter will not be able to obtain accurate readings and consequently the analyzer bandpass filter will not be correctly tuned. Thus, it may be necessary to raise the Stop value from -60 dBFS to higher amplitudes if results appear erratic. The graph Y axis is calibrated from -20 dB to -120 dB. For better display of data after measurement of a particular device, use the Optimize function (click right mouse button on graph for a list of graph-related commands).

**Stereo:** Both generator Channels are on but only Channel A will be swept, measured, and plotted as the test is set up. To test a stereo device, click the Stereo Sweep checkbox at the bottom of the Sweep panel on Page 2. Since the Track A box is checked on the generator panel, the Channel B generator amplitude will follow the same values as Channel A. Since the reading meter can only measure one channel at a time, the stereo sweep will first sweep and plot Channel A, then switch analyzer channels automatically and sweep and plot Channel B onto the same graph.

## **DIM IMD vs. amplitude**

---

### **D-a DIM vs ampl.at2c**

The IMD option is required for this test.

**Purpose:** This test is set up to measure and graph dynamic intermodulation distortion (DIM, also sometimes called TIM for transient IM) as a function of stimulus signal amplitude on a digital-to-analog audio device such as a D/A converter. Mono or stereo devices may be tested.

**Stimulus:** The Digital Generator is set to a “resting” Amplitude of zero dBFS before and after the sweep. Both channels A and B are turned on. The waveform selected is IMD DIM. No user-settable values

are involved. The signal consists of two components: a squarewave at 1/16 sample rate for sample rates of 46.000 kHz and above, or 1/14 sample rate for sample rates below 46.000 kHz, combined with a sinewave at 100/21 times the squarewave frequency. At the two most common sample rates, the resulting frequencies are:

<b>Sample Rate</b>	<b>Square Freq.</b>	<b>Sine Freq.</b>
48 kHz	3 kHz	14.2857 kHz
44.1 kHz	3.15 kHz	15.000 kHz

The sinewave peak-to-peak amplitude is one-fourth that of the squarewave.

**Measurement:** The reading meter of the Analog Analyzer is in DIM function. The System Two Cascade DIM IM analyzer measures the amplitude of the spectrum between 750 Hz and 2.4 kHz, which will include fifth and sixth order intermodulation products of the sinewave and squarewave.

**Sweep and Display:** The sweep is 30 2-dB steps (31 values) from 0 dBFS to -60 dBFS, sweeping from low to high amplitude. The graph Y axis is calibrated from -20 dB to -130 dB. For better display of data after measurement of a particular device, use the Optimize function (click right mouse button on graph for a list of graph-related commands).

**Stereo:** Both generator Channels are on but only Channel A will be swept, measured, and plotted as the test is set up. To test a stereo device, click the Stereo Sweep checkbox at the bottom of the Sweep panel on Page 2. Since the Track A box is checked on the generator panel, the Channel B generator amplitude will follow the same values as Channel A. Since the reading meter can only measure one channel at a time, the stereo sweep will first sweep and plot Channel A, then switch analyzer channels automatically and sweep and plot Channel B onto the same graph.

## Interchannel phase vs. frequency

---

### D-a relative phase.at2c

**Purpose:** This test is set up to measure and graph interchannel phase difference of a digital-to-analog stereo or other two-channel audio device such as a D/A converter, as a function of frequency.

**Stimulus:** The Digital Generator is set to an Amplitude of 1.000 FFS (fraction of full scale) on both channels A and B, with both turned on. The “resting” frequency before and after the sweep is 1 kHz.

**Measurement:** The Phase meter measures phase difference between the signals at the two analyzer input connectors. It is fully-specified for accuracy only with signal amplitudes of 5 mV and above on both channels.

**Sweep and Display:** The sweep is 70 steps (71 values) logarithmically-spaced from 20 Hz to 24 kHz, sweeping from low to high. The graph Y axis covers the  $\pm 10$  degree range. If values on the particular device under test plot off the top or bottom of the graph, use the Optimize function (click right mouse button on graph for a list of graph-related commands).

**Stereo:** Interchannel phase is intrinsically a measurement made only on stereo or two-channel devices.

## Linearity

---

### D-a linearity.at2c

**Purpose:** This test is set up to measure and graph deviation from perfect input-output linearity of a digital-to-analog mono or stereo audio device such as a D/A converter.

**Stimulus:** The Digital Generator is set to a “resting” Amplitude 1.00 FFS (fraction of full scale) before and after the sweep. Both channels A and B are turned on. The waveform is a sinewave with a frequency of 200 Hz.

**Measurement:** The reading meter of the Analog Analyzer is in Bandpass function with the Bandpass filter frequency steered by the Sweep Track selection of the BP/BR Filter Frequency field. Sweep Track causes the filter to track the frequency of whichever instrument is selected at Source 1 on the Sweep panel, in this case the Digital Generator. Bandpass function is used to produce a frequency-selective amplitude measurement which rejects noise across most of the spectrum in order to measure the generator signal amplitude accurately even at amplitudes below the wide-band noise level. The F4 key should be pressed before the start of the test to set the dBr A reference to the actual output of the D/A converter under test.

**Sweep and Display:** The sweep defined by Source 1 on the Sweep panel consists of 60 steps of two-dB size from zero dBFS to -120 dBFS. The intent is to test a typical D/A converter from full scale to near or below its noise level, and Start and Stop values may be changed as required by a particular device. The reading meter measurements are plotted at both Data 1 and Data 2 in dBr A units. The purpose of plotting the same data at Data 1 and 2 is to apply the Compute Linearity function to Data 2 while leaving the original unmodified data at Data 1. A perfectly linear device will result in a straight diagonal trace across the entire range with the horizontal and vertical coordinates of each point exactly equal. To make it easier to see small deviations from perfect linearity, the Compute Linearity function is set up to automatically execute following the last point of the sweep. Compute Linearity operates by fitting a best straight line to the data over a certain range (-20 dBFS to -40 dBFS in this case), then subtracts every measurement point from the perfect straight line. The result will be an approximately straight horizontal line near zero dBr A on Data 2. Use the right mouse button and select the Optimize Individually command following the Compute Linearity operation to automatically select a new graph top and bottom to best display the deviation from linearity graph. Most good D/A converters can be expected to be very linear from a few dB below full scale down to approximately the noise level. At some point well below the wideband noise level, the curve can be expected to swing upwards since the analyzer measurement is still influenced by noise falling within the bandpass filter range.

Stereo: Both generator Channels are on but only Channel A will be swept, measured, and plotted as the test is set up. To test a stereo device, click the Stereo Sweep checkbox at the bottom of the Sweep panel. This will place the measurements from Channel B, automatically taken during a second sweep, into Data 3 and 4. Since the Track A box is checked on the generator panel, the Channel B generator amplitude will follow the same values as Channel A. Since the reading meter can only measure one channel at a time, the stereo sweep will first sweep and plot Channel A, then switch analyzer channels automatically and sweep and plot Channel B onto the same graph. The Compute Linearity function is set up to operate on both Data 2 (Channel A) and Data 4 (Channel B).

### Crosstalk vs. frequency

---

#### D-a xtlk.at2c

Purpose: This test measures and graphs crosstalk attenuation or stereo separation from one channel of a digital-to-analog audio device such as a D/A converter into another channel, as a function of frequency.

Stimulus: The Digital Generator is set to an Amplitude of 1.000 FFS (fraction of full scale). The “resting” frequency before and after the sweep is 1 kHz. Only the Channel A output is turned on, so that crosstalk/separation into Channel B may be measured.

Measurement: The Function Reading meter of the Analog Analyzer is in Crosstalk function, measuring the signal connected to Analyzer Channel B and expressing it in dB relative to the Level meter reading on Channel A. The analyzer thus measures the relative signal feed-through between channels. Crosstalk function uses the reading meter bandpass filter in order to reject wide-band noise and accurately measure low levels of crosstalk signal. The bandpass filter frequency is controlled by the Sweep Track selection in the BP/BR Filter Frequency field. This causes the filter to track the frequency of whatever instrument is selected at Source 1, in this case the Digital Generator.

Sweep and Display: The sweep is 30 steps (31 values) logarithmically-spaced from 20 kHz to 20 Hz, sweeping from high to

low. The graph Y axis is set for the -70 to -140 dB range. For better display of data after measurement of a particular device, use the Optimize function (click right mouse button on graph for a list of graph-related commands).

Stereo: This test is set up as a Stereo Sweep by the checkbox at the bottom of the Sweep panel, since crosstalk testing implies a two-channel device. Since crosstalk measurement requires that only one channel be driven at a time, the stereo sweep will first sweep while driving Channel A and plotting Channel B, then will switch generator and analyzer channels automatically and drive B while plotting A onto the same graph.

## FFT spectrum analysis

### D-a FFT.at2c

Purpose: This test is set up to sample, acquire, and perform an FFT (Fast Fourier Transform) spectrum analysis on one or two channels of an analog output audio device. Stimulus signal to a D/A converter may be supplied by System Two Cascade's digital generator, but the test may also be used to acquire any audio signal including playback of recordings, broadcast signals, real-time speech or music, etc.

Stimulus: There is no intrinsic relation between stimulus and measurement in this test. Signal may be acquired and an FFT performed whether signal is coming from System Two Cascade's digital generator or from any other source. If the digital generator signal is to be used, it is set for a 1 kHz sinewave at an Amplitude of 1.000 FFS (fraction of full scale) with both Channel A and B outputs on.

Measurement: The FFT Spectrum Analyzer is selected on the digital analyzer panel. Its HiRes A/D converters are fed from the two input channels of the Analog Analyzer, following the input ranging circuitry and balanced-to-unbalanced conversion. A 32k sample acquisition and FFT is selected. The 65536 Hz sample rate is selected for the A/D converters, but the 131k or 262k rates could be selected for wider bandwidth spectrum analysis at some cost in residual noise and distortion.

Sweep and Display: FFT channels 1 and 2, fed from analog input channels A and B, are set up as Data 1 and Data 3 selections by checking Stereo Sweep. The zero to -150 dBr A graph top and bottom selected will cover the range of most signals. The F4 function key should be pressed before F9 or Go is clicked, which will write the presently-measured Level A and Level B readings into the dBr A and dBr B Reference fields. The Optimize command of the graph right mouse button dialog may be selected to provide better graphical resolution. Source 1 selects frequency domain (spectrum analysis) and plots the zero to 32 kHz range on a linear axis. Smaller portions of this range may be selected by zooming with the mouse or changing the Source 1 Start and Stop values. A logarithmic horizontal axis may be selected if both Start and Stop are positive values. If the 131k or 262k A/D sample rates are selected, the plotted bandwidth may be increased to about 60 kHz or 120 kHz respectively by changing the Source 1 Stop value.

Stereo: As set up, the test measures both channels simultaneously. If signal is present on only one channel, the other trace may be turned off by un-checking Stereo Sweep or by disabling the trace in the first column of the graph legend.

## Waveform display

---

### D-a view waveform.at2c

Purpose: This test is set up to sample, acquire, and display the waveform of one or two channels of an analog output audio device. Stimulus signal may be supplied by System Two Cascade's digital generator, but the test may also be used to acquire any audio signal including playback of recordings, broadcast signals, real-time speech or music, etc.

Stimulus: There is no intrinsic relation between stimulus and measurement in this test. Signal may be acquired and displayed whether signal is coming from System Two Cascade's digital generator or from any other source. If the digital generator signal is to be used, it is set for a 1 kHz sinewave at an Amplitude of 1.000 FFS (fraction of full scale) with both Channel A and B outputs on.



**Measurement:** The FFT Spectrum Analyzer is selected on the digital analyzer panel. Its HiRes A/D converters are fed from the two input channels of the Analog Analyzer, following the input ranging circuitry and balanced-to-unbalanced conversion. A 512 sample acquisition is selected. The A/D converters operate at the 65536 Hz sample rate, but 131k or 262k may also be selected for wider bandwidth.

**Sweep and Display:** FFT channels 1 and 2, fed from analog input channels A and B, are set up as Data 1 and Data 2 selections. Presuming a typical D/A converter output amplitude around two volts RMS (5.6 volts p-p), the graph top and bottom are set to +4 and -12 Volts at Data 1 and +12 and -4 Volts at Data 2. These settings cause the two channels to display in dual-trace oscilloscope fashion. If it is desired to put the two channel traces on top of one another for comparison, the Optimize Together command of the graph right mouse button dialog will accomplish this automatically and will optimize the display for signals of significantly higher or lower amplitude. Source 1 selects time domain (oscilloscope mode) and plots the zero to three millisecond range on a linear axis. Smaller portions of this range may be selected by zooming with the mouse or changing the Source 1 Start and Stop values. The record length with 512 samples is approximately 7.8 milliseconds (512 samples/65,536 samples per second) and the Source 1 Start and Stop values may be set anywhere in this range to view the desired portion of the acquired record. To acquire longer durations, change the FFT and Acquire values on the FFT panel. The time span between Start and Stop values may be set as desired and is typically equal to several periods of the signal when viewing a sinewave.

**Stereo:** As set up, the test measures both channels simultaneously. If signal is present on only one channel, the other trace may be turned off either by selecting “None” instead of the FFT channel at the Data 1 or Data 2 Browser, or by disabling the trace in the first column of the graph legend.

## Multitone Test Suite

**D-A MULTITONE.APB, D-A MULTI FRQ RESP.AT2, D-A MULTI DISTORTION.AT2, D-A MULTI NOISE.AT2, D-A MULTI XTLK.AT2, D-A MULTI PHASE.AT2**

Purpose: procedure **D-A MULTITONE.APB** is a complete multitone test suite for a digital input-analog output device. It uses the Multitone Analyzer (FASTTEST) as the Digital Analyzer along with a stereo multitone file selected as the Arbitrary Waveform at the digital generator. It measures frequency response, total distortion, noise, crosstalk (separation), and interchannel phase using multitone technology and saves the results to disk. Unneeded tests may be removed from the procedure. The test files used by **D-A MULTITONE.APB** are as follows:

- **D-A MULTI FRQ RESP.AT2C** (frequency response, result saved as **RESPONSE.AT2C**)
- **D-A MULTI DISTORTION.AT2X** (total distortion and noise, result saved as **DISTORT.AT2C**)
- **D-A MULTI NOISE.AT2C** (noise, result saved as **NOISE.AT2C**)
- **D-A MULTI XTLK.AT2C** (crosstalk/separation, result saved as **CROSSTALK.AT2C**)
- **D-A MULTI RELATIVE PHASE.AT2C** (interchannel phase, result saved as **PHASE.AT2C**)

Stimulus: All five tests are stored with the multitone waveform file **C:\APWIN\WAVEFORM\8k48k.ags** as the digital generator Arbitrary Waveform. This file consists of 30 equal-amplitude tones at identical frequencies on both channels A and B, plus six unique tones for crosstalk (separation) measurement on channel A and six other unique tones on channel B. The 30 tones common to both channels are at approximate ISO 1/3-octave band centers from 23 Hz to 20 kHz. The crosstalk tones, at slightly different frequencies on channels A and

B, are approximately positioned at octave spacing from about 550 Hz to about 17 kHz. The digital generator output could be turned off on each test file after the first one, since signal is acquired only during the first test.

**Measurement:** The HiRes A/D @OSR input selection routes signals from the Analog Analyzer front end to the A/D converters whose digital outputs drive the Multitone Analyzer (FASTTEST). The OSR sample rate selection guarantees that the A/D converter sample rate is exactly synchronized to the digital generator output sample rate (OSR). Output signal from the device under test is acquired only once, when the first test (D-A MULTI FRQ RESP) is loaded. The remaining measurements are made by loading a test with the new setup (distortion, noise, etc.) and using the Re-Process command (Ctrl-F6) to re-analyze the signal still in DSP memory. D-A MULTI FRQ RESP uses the Response function of FASTTEST. D-A MULTI DISTORT uses the Distortion function, D-A MULTI NOISE uses the Noise function, D-A MULTI XTLK uses the Crosstalk function, and D-A MULTI PHASE uses the Spectrum function (required for phase measurements) with the Channel 2 Phase Display field set to Interchannel. The procedure inserts a one-second delay after loading D-A MULTI FRQ RESP to allow time for the analog analyzer autoranging to stabilize on the output level from the device. For optimum speed during repetitive testing of similar devices, the input ranges of D-A MULTI FRQ RESP should be fixed on a range that accommodates that signal level and the one-second delay should be removed from the procedure. This presumes that the output level is known in advance and will be relatively constant from unit to unit.

**Sweep and Display:** The graph horizontal axis is set for 20 Hz-24 kHz logarithmic in all five tests, but Sweep Tables are used to determine the exact frequency values at which data will be transferred from the DSP to the computer. All the tests except D-A MULTI XTLK use C:\APWIN\WAVEFORM\8kmono.ads as the Sweep Table. This file lists the exact frequencies of the 30 tones common to both channels (monaural signal). D-A MULTI XTLK uses C:\APWIN\WAVEFORM\8k\_xtlk.ads for a Sweep Table. This file lists six frequencies that are approximately centered between each pair of unique A and B channel tones. With Multitone Analyzer

in Crosstalk function, the DSP supplies the amplitude of the nearest unique tone on each channel in response to a query from the computer for data at a particular frequency. Thus, the two curves plotted by `D-A MULTI XTLK` for A to B and B to A crosstalk are perfectly accurate in amplitude for the actual signals used, but misstate the exact frequencies by a few percent to bring them to a central value for plotting.

**Stereo:** All five tests are set up for stereo devices. To use the tests with monaural devices, load each test, select “None” as the Instrument at Data 2, and re-save the test.

## Digital-to-Digital

### General Information

An SYS-2522 (Dual Domain) unit is required for all tests in this section. A standard installation places System Two Cascade digital-to-digital tests in the `C:\APWIN\S2CASCADE\D-D` subdirectory.

**Digital Generator:** All the tests described in this section use System Two Cascade’s digital generator. This generator drives the XLR Bal, BNC Unbal, and Optical digital output connectors simultaneously. However, the actual interface signal output voltage (or optical signal amplitude, in the case of optical) at a connector will correspond to the Output Voltage setting field on the DIO Panel only for the connector selected in the Output Format field. Thus, Output Format should be changed from XLR (bal) to BNC (unbal) or Optical if the device under test is driven from the BNC or Optical connector instead of the XLR. Most tests in this section are set up with the Output Resolution field of the DIO Panel set to 24 bits. The Output Resolution field determines at which bit level (word width) the internally-generated 24-bit signal is rounded, with dither (if enabled) added at the appropriate amplitude for a signal of that resolution. It is generally desirable to change the Output Resolution value to the known input resolution of the device under test; this is particularly critical when tests are made of the low-amplitude performance of the device such as linearity and noise. All tests are set up with Triangular dither enabled, but Rectangular or Shaped dither or no dither may be selected via the DIO panel.

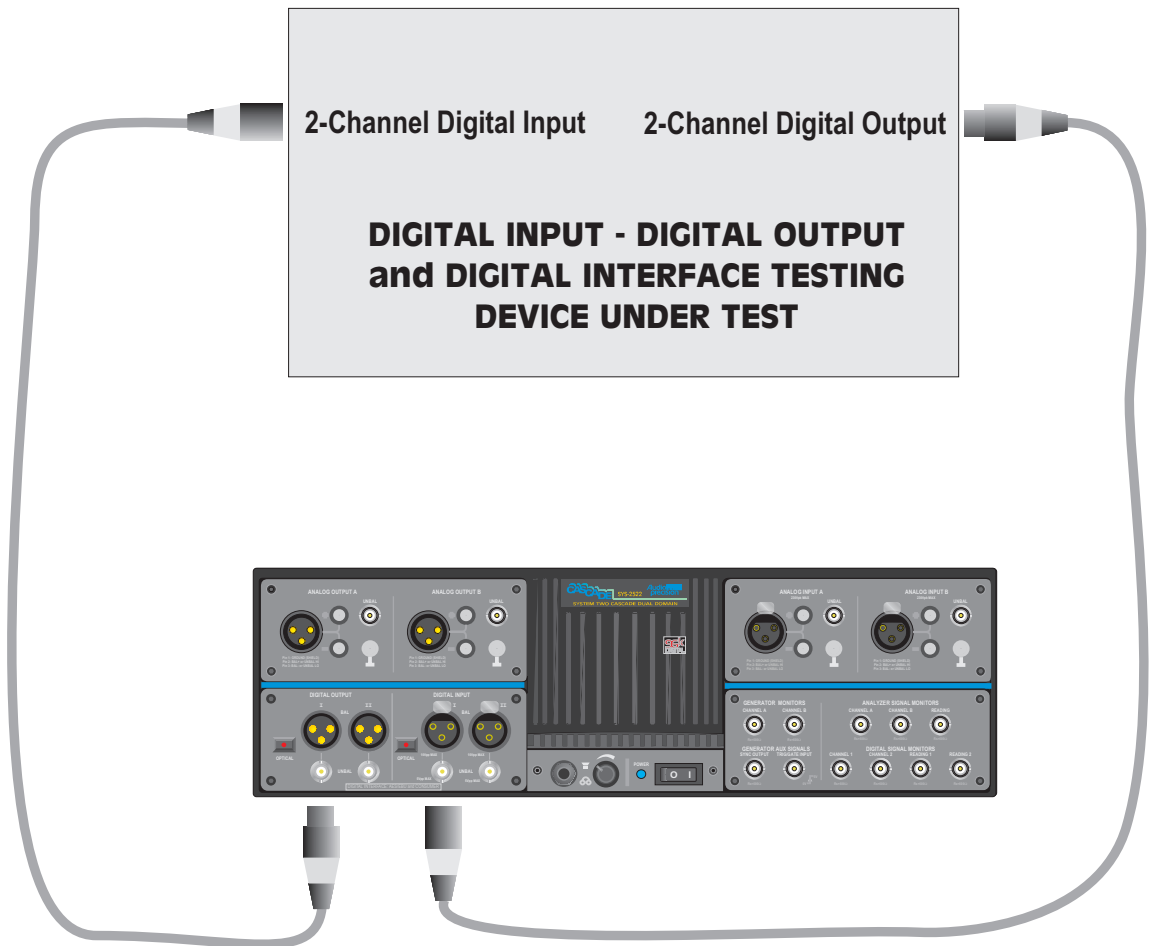

Sample Rate, Digital Output: All tests described in this section except for the Dual Connector tests are set up with the presumption that the device under test is to be tested at a 48 kHz sample rate. The Dual Connector test is set up with a 96 kHz sample rate. To test at a different rate, enter the desired rate at the Output Rate field on the DIO panel. If a rate lower than 48 kHz is chosen and no changes have been made to the tests in this section as provided, many of them will fail with an error message of the form “Conflict with maximum DSP setting

value while setting XXX (Source 1 parameter) to nnn kHz.” To adapt a test to any specific sample rate, change the upper frequency value at Source 1 on the Sweep Panel from its stored value (typically either 20 kHz or 24 kHz) to a value not greater than  $\frac{1}{2}$  the actual sample rate.

**Status Bits:** All tests in this section are set up to transmit status bits in the Professional format with sample rate and emphasis not indicated on both channels (hex code of 01 00 00 00 for bytes 0-3). Many digital input devices, particularly digital recorders, will not accept a digital input unless the status bits on the digital signal correspond to what the digital product designer thought was appropriate. If the device under test requires other status bits in order to function as desired, the Status Bits panel should be used to set the desired output. This panel may be displayed by clicking on the Status Bits button at the lower right of the large form of the DIO panel, by clicking on the STAT BIT icon on the toolbar, or via the Panels Status Bits menu command. The Professional/Consumer selection is almost always important, and it may also be important that the transmitted Sample Frequency information in the status bits matches the actual Sample Rate being generated by System Two Cascade. The Sample Frequency information in the status bits is not automatically set when System Two Cascade sample rate is changed. When Consumer format is selected, most digital recorders will not accept digital input signal unless Non-Copyright is selected.

**Digital Analyzer Input Configuration:** All tests except the Dual Connector test described in this section are set up expecting a single AES/EBU or SPDIF format digital input signal connected to the XLR Digital Input connector. If the device output format is coaxial or optical, the DIO Panel Input Format selection must be changed from XLR (bal) to BNC (unbal) or Optical. The DIO Panel Input Res. (bits) field should be set to the known word width of the digital input signal. If the word width is unknown, the Active Bits display of the DIO Panel (large form) should be used to determine the word width.

**Audio Frequency Range vs. Sample Rate, Digital Input:** The digital analyzer always locks to the sample rate of the digital input signal and is completely independent from the digital generator output sample rate, so sample rate converters may be tested. All tests described in this section except the Dual Connector test are set up with the presumption

that the device under test has a sample rate of at least 48 kHz. If the device has a lower rate and no changes have been made to the test, many of the tests as provided will fail with an error message of the form “Conflict with maximum DSP setting value while setting XXX (Source 1 parameter) to nnn kHz.” To adapt a test to any specific sample rate, change the upper frequency value at Source 1 on the Sweep Panel from its stored value (typically either 20 kHz or 24 kHz) to a value not greater than  $\frac{1}{2}$  the sample rate.

## Fast Frequency response

### D-d frq resp.at2c

**Purpose:** This test is set up to very rapidly measure and graph frequency response on a digital input, digital output device. Mono or stereo devices may be tested, as described below.

**Stimulus:** The Sine waveform of the Digital Generator is selected. Amplitude is -0.5 dBFS, “resting” frequency before and after the sweep is 1 kHz.

**Measurement:** The DSP Audio Analyzer program is selected on the Digital Analyzer panel. The Digital input selection routes signals from the digital-input connector selected on the DIO panel (XLR as stored) to the DSP Audio Analyzer. The Fast RMS detector is chosen for maximum measurement speed. The Channel A and B Level meters make the measurement.

**Sweep and Display:** The sweep is 50 steps (51 values) logarithmically-spaced from 24 kHz to 20 Hz, sweeping from high to low. A complete sweep should take well under two seconds. Raising the Stop frequency can further increase sweep speed if data down to 20 Hz is not required. The graph Y-axis covers the zero to -1 dBFS range. If values on the particular device under test plot off the top or bottom of the graph, use the Optimize function (click right mouse button on graph for a list of graph-related commands)

**Stereo:** The test is set up as a stereo test. To test a single channel digital path, un-check the Stereo Sweep checkbox.

## Dual Connector Device, Frequency Response

---

### D-d dual connector frq resp.at2c

**Purpose:** This test is set up as an example for test interfacing to dual connector devices. These are typically used to connect to older multi-channel 48 kHz products such as multi-track recorders when the benefits of higher (96 kHz) sample rates are desired. Two 48 kHz channels on the recorder are used to carry a single (monaural) 96 kHz digital signal, permitting the existing recorder AES/EBU interface chips and other circuitry to continue to be used. Dual connectors on the digital audio test set are then required to provide stereo testing capabilities. This test is a frequency response test and is intended to be used as a model for additional tests such as distortion, FFTs, etc. Dual XLR is selected in both the Output Format and Input Format fields of the DIO panel. Output Sample Rate is set to 96 kHz.

**Stimulus:** The digital generator is used in sinewave mode. Frequency range is extended to twice normal values by the 96 kHz sample rate. The generator amplitude is set to -0.5 dBFS.

**Measurement:** DSP Audio Analyzer makes the measurements, with twice the bandwidth of 48 kHz operation. Fast RMS detector operation is used for rapid testing speed.

**Sweep and Display:** Source 1 sweeps the Digital Generator frequency while the Level A and B meters are plotted at Data 1 and 3, selected by the Stereo Sweep box. Graph top and bottom values are 0 dBFS and -1.0 dBFS.

**Stereo:** The test is set up as a stereo test but can be converted to single-channel use by un-checking the Stereo Sweep box.

## Noise (single point)

---

### D-d noise.at2c

**Purpose:** This test is set up to measure noise, integrated across the audio spectrum, on a mono or stereo digital-to-digital audio device. The result is a single number (per channel), not a graph.



**Stimulus:** The Digital Generator output is turned off. Triangular dither is selected on the DIO panel and the Output Resolution (word width) is set to 24 bits. The Output Resolution value should be changed to correspond to the digital input resolution of the device under test in order to establish dither amplitude properly.

**Measurement:** The Function Reading meter of the DSP Audio Analyzer is in Amplitude function using the RMS detector. The CCIR quasi-peak (Q-Pk) detector may be used instead for a CCIR 468 weighted noise measurement, by selecting “4/sec” and “QPK” in the Det: fields of the digital analyzer panel. The high and low pass filters are set to the 22 Hz to 20 kHz range. Thus, the measurement will be limited to noise in the standard audio band. Filter selections can be changed to other bandwidths or a weighting filter if desired via the BW and Fltr fields of the digital analyzer panel.

**Sweep and Display:** A single-point measurement is made (no sweep) and tabular results are displayed in the Data Editor since a graph cannot be made of a single point. The reason for selecting DGen Amplitude A as the Source 1 parameter, with an extremely low value as the Start value, is merely to create a Column heading and value in column one of the Data Editor which helps indicate that this is a noise measurement (no signal). Since the generator output is turned off on the generator panel, the actual Source 1 parameter and setting is not important.

**Stereo:** The test is set up as a stereo sweep since most digital devices are stereo. Two simultaneous single-point measurements will be made by the two Function Reading meters. If a monaural digital channel is to be tested, un-check the Stereo Sweep checkbox at the bottom of the Sweep panel and only Channel A will be tested.

### **THD + N vs. frequency**

---

#### **D-d THD+N vs freq.at2c**

**Purpose:** This test is set up to measure and graph THD+N (total harmonic distortion plus noise) as a function of stimulus frequency across the audio band on a digital-to-digital audio device. Mono or stereo devices may be tested.

**Stimulus:** The Digital Generator is set to an Amplitude of zero dBFS. The Track A checkbox at Channel B is checked to assure the same level on both channels A and B. Both channels are turned on. The “resting” frequency before and after the sweep is 1 kHz.

**Measurement:** The Function Reading meters of the DSP Audio Analyzer are in THD+N Ratio function with the high and low pass filters set to the 22 Hz to 20 kHz range. A 15 kHz low-pass selection is also available.

**Sweep and Display:** The sweep is 30 steps (31 values) logarithmically-spaced from 20 kHz to 20 Hz, sweeping from high to low. The graph Y axis is calibrated in dB below signal level, from -70 to -150 dB. For better display of data after measurement of a particular device, use the Optimize function (click right mouse button on graph for a list of graph-related commands).

**Stereo:** Since most digital devices are stereo, the test is set up in Stereo Sweep mode. Both channels will be measured and plotted simultaneously by the two Function Reading meters. To test a single channel device, un-check the Stereo Sweep checkbox and only Channel A will be tested.

## **THD + N vs. amplitude**

---

### **D-d THD+N vs ampl.at2c**

**Purpose:** This test is set up to measure and graph THD+N (total harmonic distortion plus noise) as a function of stimulus signal amplitude across a wide dynamic range on a digital-to-digital audio device. Mono or stereo devices may be tested.

**Stimulus:** The Digital Generator is set to a “resting” Amplitude of 1.000 FFS (fraction of full scale) before and after the sweep. Both channels A and B are turned on. The frequency is 1 kHz. The frequency may be changed to any other desired value, but it should be recognized that the band-limited nature of the digital device plus the analyzer 20 kHz low-pass filter will attenuate high-frequency harmonics.

**Measurement:** The Function Reading meters of the DSP Audio Analyzer are in THD+N Amplitude function with the high and low pass filters set to the 22 Hz to 20 kHz range. Note that the 20 kHz low-pass filter will attenuate second harmonic products from fundamentals above 10 kHz, third harmonics of fundamentals above 6.7 kHz, etc. THD+N Amplitude states distortion and noise in absolute terms (%FSe, dBFS, etc.) rather than relative to the present signal amplitude.

**Sweep and Display:** The sweep is 25 2-dB steps (26 values) from zero dBFS to -50 dBFS, sweeping from high to low amplitude. The graph Y axis is calibrated in dBFS (decibels below digital full scale) from -80 to -150 dBFS. An ideal digital device would be limited only by the intrinsic quantization distortion and noise due to its resolution (word width), independent of signal level. Therefore, an absolute distortion vs. amplitude curve can be expected to be approximately a horizontal straight line across the graph. For better display of data after measurement of a particular device, use the Optimize function (click right mouse button on graph for a list of graph-related commands).

**Stereo:** Since most digital devices are stereo, this test is set up with the Stereo Sweep checkbox checked. Both channels are measured and plotted simultaneously in a single sweep by the two Function Reading meters. If a mono device is to be tested, un-check the Stereo Sweep checkbox and only Channel A will be measured.

## **SMPTE IMD vs Amplitude**

---

### **D-d SMPTE vs ampl.at2c**

**Purpose:** This test is set up to measure and graph SMPTE or DIN IMD (intermodulation distortion) as a function of stimulus signal amplitude on a digital-to-digital audio device. Mono or stereo devices may be tested.

**Stimulus:** The Digital Generator is set to an Amplitude of zero dBFS. Both channels A and B are turned on. The waveform selected is IMD SMPTE 4:1 with a high frequency sinewave at 7 kHz and low frequency sinewave at 60 Hz. To test to the German DIN standard, the high frequency should be changed to 8 kHz and the low-frequency to 250 Hz.

**Measurement:** The DSP Audio Analyzer is selected on the digital analyzer panel. Digital input is selected, with the Function Reading meters in SMPTE/DIN function. Graph top and bottom values of -70 and -130 dB are selected.

**Sweep and Display:** The horizontal axis is set by Source 1 Start and Stop for a Digital Generator amplitude sweep from zero dBFS to -50 dBFS in 25 steps (26 measurements).

**Stereo:** As set up, the test measures both channels simultaneously. If signal is present on only one channel, the other trace may be turned off either by un-checking the Stereo Sweep box or by disabling the trace in the first column of the graph legend.

## CCIF IMD

---

### D-d CCIF FFT.at2c

**Purpose:** This test is set up to measure and graph CCIF/DFD (also called twin-tone or difference-tone) intermodulation distortion on a digital-to-digital audio device. Mono or stereo devices may be tested.

**Stimulus:** The Digital Generator is set to an Amplitude of zero dBFS. Both channels A and B are turned on. The waveform selected is IMD CCIF. The settings of 13.5 kHz Center Frequency and 1.00 kHz IM Frequency (difference between the tones) produce two equal-amplitude sinewaves spaced by the difference frequency value around the center frequency. Thus, the sinewaves will be at 13.0 kHz and 14.0 kHz with the settings stored in the test. Other frequencies may be used.

**Measurement:** The FFT analyzer program is selected on the digital analyzer panel. Digital input is selected, with digital channel A selected as Channel 1 and channel B as Channel 2. A 32k sample acquisition and FFT is selected. The digital input will lock to a wide range of sample rates. “

**Sweep and Display:** The horizontal axis is set by Source 1 Start and Stop to the full audio spectrum between zero and 24 kHz. This pre-supposes a 48 kHz or higher sample rate from the A/D unit under test. If the sample rate is lower than 48 kHz, the Source 1 Stop

frequency must be changed to a value no higher than  $\frac{1}{2}$  the sample rate. The spectrum displayed will include the test signal tones at 13 kHz and 14 kHz and all intermodulation distortion products falling within the range. The second order IMD product (difference tone) will fall at  $f_2 - f_1$ , or 1 kHz. Third order IMD products fall at  $2f_2 - f_1$  ( $28 - 13 = 15$  kHz) and  $2f_1 - f_2$  ( $26 - 14 = 12$  kHz). One graph cursor can be placed on either of the test tones and the second cursor placed on any IMD product. The “dy” (difference in y coordinate) display at the graph top will then show the amplitude of each intermodulation distortion product.

**Stereo:** As set up, the test measures both channels simultaneously. If signal is present on only one channel, the other trace may be turned off either by un-checking the Stereo Sweep box or by disabling the trace in the first column of the graph legend.

## DIM IMD

### D-d DIM FFT.at2c

**Purpose:** This test is set up to measure and graph DIM (dynamic) or TIM (transient) intermodulation distortion on a digital-to-digital audio device. Mono or stereo devices may be tested.

**Stimulus:** The Digital Generator is set to an Amplitude stat of zero dBFS. Both channels A and B are turned on. The waveform selected is Digital DIM. No user-settable values are involved. The signal consists of two components: a squarewave at  $1/16$  sample rate for sample rates of 46.000 kHz and above, or  $1/14$  sample rate for sample rates below 46.000 kHz, combined with a sinewave at  $100/21$  times the squarewave frequency. At the two most common sample rates, the resulting frequencies are:

<b>Sample Rate</b>	<b>Square Freq.</b>	<b>Sine Freq.</b>
48 kHz	3 kHz	14.2857 kHz
44.1 kHz	3.15 kHz	15.000 kHz

**Measurement:** The FFT Spectrum Analyzer is selected on the digital analyzer panel. Digital input is selected, with digital channel A selected as Channel 1 and channel B as Channel 2. A 32k sample acquisition

and FFT is selected. The digital input will lock to a wide range of sample rates.“

**Sweep and Display:** The horizontal axis is set by Source 1 Start and Stop to the full audio spectrum between zero and 24 kHz. This pre-supposes a 48 kHz or higher sample rate from the unit under test. If the sample rate is lower than 48 kHz, the Source 1 Stop frequency must be changed to a value no higher than  $\frac{1}{2}$  the sample rate. The spectrum displayed will include the test signal sinewave tone plus the squarewave fundamental frequency and squarewave third, fifth, and seventh harmonics. IMD products may occur at the sum and difference frequencies of all combinations of squarewave fundamental and harmonics with the sinewave probe tone. One graph cursor can be placed on the “probe” tone and the second cursor placed on the IMD product of interest. The “dy” (difference in y coordinate) display at the graph top will then show the amplitude of that intermodulation distortion product.

**Stereo:** As set up, the test measures both channels simultaneously. If signal is present on only one channel, the other trace may be turned off either by un-checking the Stereo Sweep box or by disabling the trace in the first column of the graph legend.

## **Interchannel phase vs. frequency**

---

### **D-d relative phase.at2c**

**Purpose:** This test is set up to measure the interchannel phase versus frequency characteristic of a digital-to-digital device.

**Stimulus:** The Digital Generator is in sinewave mode at full-scale amplitude.

**Measurement:** The DSP Audio Analyzer is selected with the Function Reading meter is Phase function.

**Sweep and Display:** Source 1 is a Digital Generator sweep from 20 Hz to 24 kHz in 70 logarithmic steps. Data 1 plots the Phase function of the DSP analyzer. If the measured phase difference exceeds the  $\pm 10$  degree range at Data 1 Graph Top and Bottom, the Optimize

command of the graph right mouse button menu may be used to fit the graph top and bottom to the actual measured data.

Stereo: Interchannel phase is intrinsically a stereo test.

## Linearity

### D-d linearity.at2c

**Purpose:** This test is set up to measure and graph deviation from perfect input-output linearity of a digital-to-digital mono or stereo audio.

**Stimulus:** The Digital Generator is set to a “resting” Amplitude 1.00 FFS (fraction of full scale) before and after the sweep. Both channels A and B are turned on. The waveform is a sinewave with a frequency of 200 Hz. The Output Resolution on the DIO panel is set to 24 bits; it should be changed if necessary to match the input resolution of the device under test.

**Measurement:** The DSP Audio Analyzer is selected on the Digital Analyzer panel. The analyzer Function Reading meters are in Bandpass function with the Bandpass filter frequency controlled by the Sweep Track selection of the BP/BR Tuning field. Sweep Track steers the filters to the present frequency of the instrument selected at Source 1, which is the Digital Generator in this case. Bandpass function is used to produce a frequency-selective amplitude measurement which rejects noise across most of the spectrum in order to measure the generator signal amplitude accurately even at amplitudes below the wide-band noise level. The Input Resolution on the DIO panel is set to 24 bits; it should be changed if necessary to match the output resolution of the device under test.

**Sweep and Display:** The sweep defined by Source 1 on the Sweep panel consists of 70 steps (71 measurement points) of two-dB size from 0 dBFS to -140 dBFS. The intent is to test a device from digital full scale to below the wideband noise level. Start and Stop values may be changed as required by a particular device. The Channel A measurements are plotted at Data 1 and Data 2 in dBFS. Channel B measurements are plotted at Data 3 and Data 4. The purpose of plotting each channel twice is so that the Compute Linearity function

may be used on one trace while still preserving the original data. A perfectly linear device will result in a straight diagonal trace across the entire range with the horizontal and vertical coordinates of each point exactly equal. To make it easier to see small deviations from perfect linearity, the Compute Linearity function is set up to automatically execute on the Data 2 (second instance of Channel A data) and Data 4 (second instance of Channel B data) following the last point of the sweep. Compute Linearity operates by fitting a best straight line to the data over a certain range (-20 dBFS to -40 dBFS in this case), then subtracts every measurement point from the perfect straight line. The result will be an approximately straight horizontal line near zero dBFS for the Data 2 and 4 traces. Use the right mouse button and select the Optimize Individually command following the Compute Linearity operation to automatically select a new graph top and bottom for the Data 2/4 (right hand) vertical axis to best display the deviation from linearity graph. The original diagonal traces will still be plotted, calibrated against the left-hand vertical axis. Most devices can be expected to be very linear from a few dB below full scale down to approximately the noise level. At some point well below the wideband noise level, the curve can be expected to vary since the analyzer measurement is still influenced by noise falling within the bandpass filter range.

**Stereo:** Most digital devices are stereo, so the test is set up with the Stereo Sweep checkbox checked. Both channels are measured and plotted simultaneously. To test a monaural Channel A device, un-check the Stereo Sweep checkbox.

## Crosstalk vs. frequency

---

### D-DXTALK.AT2

**Purpose:** This test measures and graphs crosstalk attenuation or stereo separation from one channel of a digital-to-digital audio device into another channel, as a function of frequency.

**Stimulus:** The Digital Generator is set to an Amplitude of zero dBFS. The “resting” frequency before and after the sweep is 1 kHz. Only the Channel A output is turned on, so that crosstalk/separation into Channel B may be measured.



**Measurement:** The Digital Domain Audio Analyzer DSP program (ANALYZER.AZ2) is selected on the Digital Analyzer panel. Digital Channel B is connected to the reading meter of the Digital Domain Analyzer, which is in Crosstalk function. Crosstalk function measures the signal connected to Digital Analyzer Channel B (the non-driven channel) and expresses it in dB relative to the Digital Analyzer Level meter reading on Channel A (the driven channel). The analyzer thus measures the relative signal feed-through between channels. Crosstalk function uses the bandpass filter in order to reject wide-band noise and accurately measure low levels of crosstalk signal. The bandpass filter frequency is slaved to the Digital Generator frequency by the DGen track selection in the BP/BR Tuning field.

**Sweep and Display:** Sweep and Display: The sweep is 30 steps (31 values) logarithmically-spaced from 20 kHz to 20 Hz, sweeping from high to low. The graph Y axis extends from -60 dB at the top to -180 dB at the bottom. For better display of data after measurement of a particular device, use the Optimize function (click right mouse button on graph for a list of graph-related commands).

**Stereo:** This test is set up as a Stereo Sweep by the checkbox at the bottom of the Sweep panel, since crosstalk testing implies a two-channel device. Since the reading meter can only measure one channel at a time, the stereo sweep will first sweep while driving Channel A and plotting Channel B, then will switch generator and analyzer channels automatically and drive B while plotting A onto the same graph.

## FFT spectrum analysis

---

### D-d FFT.at2c

**Purpose:** This test is set up to sample, acquire, and perform an FFT (Fast Fourier Transform) spectrum analysis on one or two channels of a digital output audio device. Stimulus signal may be supplied by System Two Cascade's digital generator, but the test may also be used to acquire any digital domain audio signal including playback of recordings, broadcast signals, real-time speech or music, etc.

**Stimulus:** There is no intrinsic relation between stimulus and measurement in this test. Signal may be acquired and an FFT performed whether signal is coming from System Two Cascade's digital generator or from any other source. If the digital generator signal is to be used, it is set for a 1 kHz sinewave at an Amplitude of zero dBFS with both Channel A and B outputs on.

**Measurement:** The FFT Spectrum Analyzer is selected on the digital analyzer panel. Digital input is selected with Digital Channel A connected to FFT Channel 1 and Digital Channel B connected to Channel 2. A 32k sample acquisition and FFT is selected. The digital analyzer will lock to digital input sample rates over a wide range. “

**Sweep and Display:** FFT channels 1 and 2, fed from digital input channels A and B, are set up as Data 1 and Data 3 selections by checking the Stereo Sweep box. The zero to -180 dBFS (dB relative to digital full scale) graph top and bottom selected will cover the range of most signals. The Optimize command of the graph right mouse button dialog may be selected to provide better graphical resolution following an acquisition or zoom. The Source 1 FFT Freq selection chooses frequency domain (spectrum analysis) mode. The zero and 24 kHz Source 1 Start and Stop values are based on the assumption of a 48 kHz or higher sample rate. If the sample rate of the device is lower, the Source 1 Stop value must be changed to a number no greater than  $\frac{1}{2}$  the sample rate. A linear axis is chosen. Smaller portions of this range may be selected by zooming with the mouse or changing the Source 1 Start and Stop values following an acquisition. A logarithmic horizontal axis may be selected if both Start and Stop are positive values.

**Stereo:** As set up, the test measures both channels simultaneously. If signal is present on only one channel, the other trace may be turned off either by un-checking the Stereo Sweep box or by disabling the trace in the first column of the graph legend.

## **Waveform display**

---

### **D-d view waveform.at2c**

**Purpose:** This test is set up to sample, acquire, and display the waveform of one or two channels of a digital output audio device.

Stimulus may be supplied by System Two Cascade's generator, but the test may also be used to acquire any digital audio signal including playback of recordings, broadcast signals, real-time speech or music, etc.

**Stimulus:** There is no intrinsic relation between stimulus and measurement in this test. Signal may be acquired and displayed whether signal is coming from System Two Cascade's digital generator or from any other source. If the digital generator signal is to be used, it is set for a 1 kHz sinewave at an Amplitude of zero dBFS with both Channel A and B outputs on.

**Measurement:** The FFT Spectrum Analyzer is selected on the digital analyzer panel. Digital input is selected, with digital analyzer Channel 1 fed from Channel A of the digital signal and Channel 2 fed from Channel B. A 512 sample acquisition is selected, providing about 10 milliseconds of signal at a 48 kHz sample rate.

**Sweep and Display:** FFT channels 1 and 2, fed from digital input channels A and B, are set up as Data 1 and Data 2 selections. Presuming a measured signal amplitude of approximately digital full scale, the graph top and bottom are set to display signals of about 3 FFS peak-to-peak. Note that the definition of digital full scale is the rms value of a sinewave whose peaks are just touching the most positive and most negative allowable digital codes. A sinewave has a crest factor (peak-to-rms value) of 1.414. Thus, the peaks of a zero dBFS sinewave signal level will touch  $\pm 1.414$  FFS. The actual Graph Top and Bottom values of +4 FFS and -2 FFS at Data 2 and +2 and -4 FFS at Data 1 separate the two traces in dual-trace oscilloscope fashion. If it is desired to put the two channel traces on top of one another for comparison, Data 1 and Data 2 Top and Bottom values should be the same. The Optimize Together command of the graph right mouse button dialog will accomplish this automatically and will optimize the display for signals of significantly lower amplitude than one FFS. Source 1 selects FFT Time to provide time domain (oscilloscope mode) display rather than spectrum analysis. The zero to three millisecond range is selected at Source 1 Start and Stop to display five cycles if the signal is 1.00 kHz. Smaller portions of this range may be selected by zooming with the mouse or changing the Source 1 Start and Stop values. The 512 sample record length is

approximately 10.66 milliseconds (512 samples/48,000 samples per second) and the Source 1 Start and Stop values may be set anywhere in that range to view the desired portion of the acquired record. Longer acquisition durations and records may be set by the FFT and Acquire fields on the FFT panel, up to 256k samples (over five seconds at a 48 kHz rate). The time span between Start and Stop values may be set as desired and is typically equal to several periods of the signal when viewing a sinewave.

**Stereo:** As set up, the test measures both channels simultaneously. If signal is present on only one channel, the other trace may be turned off either by un-checking the Stereo Sweep box or by disabling the trace in the first column of the graph legend.

### **Bit Errors with Random Audio Signal**

---

#### **D-d bit errors random.at2c**

**Purpose:** To test the data integrity of a digital transmission path or recording-reproduction process.

**Stimulus:** Special Bittest Random waveform is chosen on the digital generator. This pseudo-random signal can take on any value between plus and minus full scale in a predictable fashion so that bit error measurements may be made by System Two Cascade's BITTEST analyzer or the bit error measurement functions of System Two, System One, and the ATS-1 Dual Domain or Portable One Dual Domain.

**Measurement:** The BITTEST analyzer is used, with Random selected as the expected waveform.

**Sweep and Display:** Bit errors on Channel A is selected at Data 1 and Channel B errors at Data 2. External sweep time is selected at Source 1, producing a chart recorder graph of errors vs time.

**Stereo:** The test is set up as a stereo or two-channel test. Either channel may be disabled by selecting None at the Data browser.

## Bit Errors and Hex Amplitudes vs Generator Amplitude, Constant Waveform

### D-d bit errors constant sweep

Purpose: To display bit errors and signal amplitude at a number of different “digital DC” values across the range.

Stimulus: Special Constant “waveform” is selected on the Digital Generator, with dither turned off. Constant “waveform” is the digital equivalent of DC, producing a stream of identical sample values at the value set by the Digital Generator amplitude field.

Measurement: The BITTEST analyzer displays the received amplitude and also errors from the transmitted signal.

Sweep and Display: Source 1 is the digital generator amplitude in FFS; during each step of the sweep, the generator continually sends a stream of identical sample values at the amplitude specified in that step. The amplitude is stepped from positive full scale to negative full scale in 16 steps, producing values at the major MSB transition points. Tabular display is selected, with the generator amplitude displayed in column zero. Columns 1 and 3 display any bit errors in Channels A and B. Columns 2 and 4 display the received amplitude on Channels A and B, in hexadecimal units.

Stereo: The test is set up to drive and measure both channels. Either channel can be disabled by selecting None in the appropriate data browser.

## Multitone Test Suite

**D-D MULTITONE.APB, D-D MULTI FRQ  
RESP.AT2C, D-D MULTI DISTORTION.AT2C, D-D  
MULTI NOISE.AT2C, D-D MULTI XTLK.AT2C, D-D  
MULTI PHASE.AT2C**

Purpose: procedure **D-D MULTITONE.APB** is a complete multitone test suite for a digital input-digital output device. It uses the Multitone Analyzer (FASTTEST) as the Digital Analyzer along with a

stereo multitone file selected as the Arbitrary Waveform at the digital generator. It measures frequency response, total distortion, noise, crosstalk (separation), and interchannel phase using multitone technology and saves the results to disk. Unneeded tests may be removed from the procedure. The test files used by **D-D MULTITONE.APB** are as follows:

- **D-D MULTI FRQ RESP.AT2C** (frequency response, result saved as **RESPONSE.AT2C**)
- **D-D MULTI DISTORTION.AT2C** (total distortion and noise, result saved as **DISTORT.AT2C**)
- **D-D MULTI NOISE.AT2C** (noise, result saved as **NOISE.AT2C**)
- **D-D MULTI XTLK.AT2C** (crosstalk/separation, result saved as **CROSSTALK.AT2C**)
- **D-D MULTI RELATIVE PHASE.AT2C** (interchannel phase, result saved as **PHASE.AT2C**)

Stimulus: All five tests are stored with the multitone waveform file **C:\APWIN\WAVEFORM\8k48k.ags** as the digital generator Arbitrary Waveform. This file consists of 30 equal-amplitude tones at identical frequencies on both channels A and B, plus six unique tones for crosstalk (separation) measurement on channel A and six other unique tones on channel B. The 30 tones common to both channels are at approximate ISO 1/3-octave band centers from 23 Hz to 20 kHz. The crosstalk tones, at slightly different frequencies on channels A and B, are approximately positioned at octave spacing from about 550 Hz to about 17 kHz. The generator output could be turned off on each test file after the first one, since signal is acquired only during the first test.

Measurement: The Digital input selection routes signal from the digital input connector selected on the DIO panel (XLR as stored) to the Multitone Analyzer (FASTTEST). Output signal from the device under test is acquired only once, when the first test (**D-D MULTI FRQ RESP**) is loaded. Loading a test with the new setup (distortion,

noise, etc.) and using the Re-Process command (Ctrl-F6) to re-analyze the signal still in DSP memory makes the remaining measurements. D-D MULTI FRQ RESP uses the Response function of FASTTEST. D-D MULTI DISTORTION uses the Distortion function, D-D MULTI NOISE uses the Noise function, D-D MULTI XTLK uses the Crosstalk function, and D-D MULTI PHASE uses the Spectrum function (required for phase measurements) with the Channel 2 Phase Display field set to Interchannel.

**Sweep and Display:** The graph horizontal axis is set for 20 Hz-20 kHz logarithmic in all five tests, but Sweep Tables are used to determine the exact frequency values at which data will be transferred from the DSP to the computer. All the tests except D-D MULTI XTLK use C:\APWIN\WAVEFORM\8kmono.ads as the Sweep Table. This file lists the exact frequencies of the 30 tones common to both channels (monaural signal). D-D MULTI XTLK uses C:\APWIN\WAVEFORM\8k\_xtlk.ads for a Sweep Table. This file lists six frequencies that are approximately centered between each pair of unique A and B channel tones. With Multitone Analyzer in Crosstalk function, the DSP supplies the amplitude of the nearest unique tone on each channel in response to a query from the computer for data at a particular frequency. Thus, the two curves plotted by D-D MULTI XTLK for A to B and B to A crosstalk are perfectly accurate in amplitude for the actual signals used, but misstate the exact frequencies by a few percent to bring them to a central value for plotting.

**Stereo:** All five tests are set up for stereo devices. To use the tests with monaural devices, load each test, select “None” as the Instrument at Data 2, and re-save the test.

## Digital Interface Tests

A System Two Cascade Dual Domain (SYS-2522) series instrument is required for these tests. A standard installation places System Two Cascade digital interface tests in the **C:\APWIN\S2CASCADE\DIOanalyzr** subdirectory.

Digital Generator: All the tests described in this section use System Two Cascade's digital generator if operated in stimulus-response mode, although all may operate on a "measure-only" basis without necessarily supplying stimulus. This generator drives the XLR Bal, BNC Unbal, and Optical digital output connectors simultaneously. However, the actual interface signal output voltage (or optical signal amplitude, in the case of optical) at a connector will correspond to the Output Voltage setting field on the DIO Panel only for the connector selected

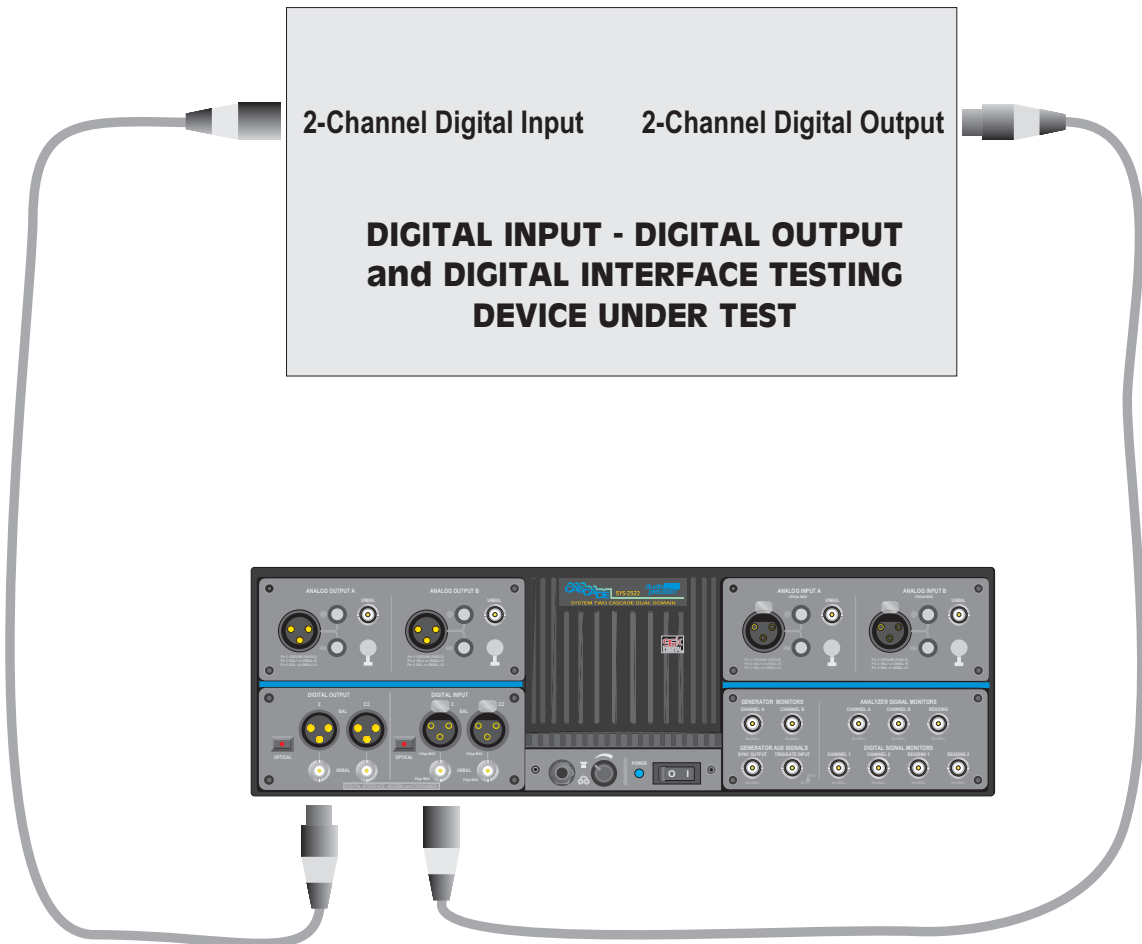



in the Output Format field. Thus, Output Format should be changed from XLR (bal) to BNC (unbal) or Optical if the device under test is driven from the BNC or Optical connector instead of the XLR. None of these tests measure the imbedded audio signal, so output parameters such as Resolution (word width) and dither are irrelevant.

**Sample Rate, Digital Output:** All the tests described in this section are set up with the presumption that the device under test is to be tested at a 48 kHz sample rate controlled from System Two Cascade's internal crystal. To test at a different rate, enter the desired rate at the Output Rate field on the DIO panel. If a rate lower than 48 kHz is chosen and no changes have been made to the tests in this section as provided, the test JIT-FFT.AT2 will fail with an error message of the form "Conflict with maximum DSP setting value while setting XXX (Source 1 parameter) to nnn kHz." To adapt this test to a specific sample rate, change the upper frequency value at Source 1 on the Sweep Panel from its stored value of 24 kHz to a value not greater than  $\frac{1}{2}$  the actual sample rate.

**Status Bits:** If stimulus from System Two Cascade is used, all tests in this section are set up to transmit status bits in the Professional format with sample rate and emphasis not indicated on both channels (hex code of 01 00 00 00 for bytes 0-3). Many digital input devices, particularly digital recorders, will not accept a digital input unless the status bits on the digital signal correspond to what the digital product designer thought was appropriate. If the device under test requires other status bits in order to function as desired, the Status Bits panel should be used to set the desired output. This panel may be displayed by clicking on the Status Bits button at the lower right of the large form of the DIO panel, by clicking on the STAT BIT icon on the toolbar, or via the Panels Status Bits menu command. The Professional/Consumer selection is almost always important, and it may also be important that the transmitted Sample Frequency information in the status bits matches the actual Sample Rate being generated by System Two Cascade. The Sample Frequency information in the status bits is not automatically set when System Two Cascade sample rate is changed. When Consumer format is selected, most digital recorders will not accept digital input signal unless Non-Copyright is selected.

Digital Analyzer Input Configuration: All the tests described in this section are set up expecting an AES/EBU or SPDIF format digital input signal connected to the XLR Digital Input connector. If the device output format is coaxial or optical, the DIO Panel Input Format selection must be changed from XLR (bal) to BNC (unbal) or Optical. The Input Resolution field setting on the DIO panel is irrelevant since none of the tests in this section measure the imbedded audio signals.

Audio Frequency Range vs. Sample Rate, Digital Input: The digital analyzer always locks to the sample rate of the digital input signal and is completely independent from the digital generator output sample rate, so sample rate converters may be tested. The test JIT-FFT.AT2 described in this section uses FFT.AZ2 and is set up with the presumption that the device under test has a sample rate of at least 48 kHz. If the device has a lower rate and no changes have been made to the test, JIT-FFT.AT2 may fail with an error message of the form “Conflict with maximum DSP setting value while setting XXX (Source 1 parameter) to nnn kHz.” To adapt the test to any specific sample rate, change the upper frequency value at Source 1 on the Sweep Panel from its stored value of 24 kHz to a value not greater than  $\frac{1}{2}$  the sample rate.

## Total jitter vs. time

---

### JIT-TIME.AT2

Purpose: This test graphs a “chart recorder” style plot of interface jitter versus time.

Stimulus: Stimulus from System Two Cascade is not necessary for this test. It can be used to measure jitter on any AES/EBU or Consumer interface signal from any source. If a digital device with a real-time path from digital input to digital output is being tested and it is desired to drive it while measuring jitter, the Digital Generator output may be connected.

Measurement: Data 1 plots readings from the DIO panel Interface Jitter meter. This meter reading is derived from the error voltage of the digital input phase locked loop. The DIO Panel is set to use the Peak jitter detector, with a jitter measurement bandwidth of 700 Hz to 100

kHz. An Average-responding (Peak-calibrated) detector is also available, as are three other values of high-pass filter to control the low frequency bandwidth of the jitter measurement. The built-in loudspeaker and stereo headphone jack are set to monitor the imbedded audio of the digital input signal.

Sweep and Display: Source 1 is set to External Sweep Time for chart recorder mode. Start and Stop times are set for zero to ten seconds with readings requested every 250 milliseconds. The vertical scale for jitter measurements is zero to 20 nanoseconds, linear. The graph right mouse button menu may be used to Optimize the data following a complete measurement in order to better display the actual measured range.

## FFT of jitter

---

### JIT-FFT.AT2

Purpose: This test performs an FFT spectrum analysis of the jitter on the digital input signal. Spectrum analysis helps identify the major frequency components of the jitter signal, which helps lead to the source of the jitter.

Stimulus: Stimulus from System Two Cascade is not necessary for this test. It can be used to measure jitter on any AES/EBU or Consumer interface signal from any source. If a digital device with a real-time path from digital input to digital output is being tested and it is desired to drive it while measuring jitter, the Digital Generator output may be connected.

Measurement: The FFT Spectrum Analyzer DSP program (FFT.AZ2) acquires signal and performs the spectrum analysis. The low-bandwidth A/D converter is used, fed from the Jitter Signal which is the error voltage from the digital input phase locked loop. The sample rate of the A/D is set to 1x the internal sample rate (48 kHz as stored), providing bandwidth out to better than 20 kHz. If spectrum analysis to 80 kHz is desired, the FFT Input selection should be changed to High Bandwidth (4x internal sample rate). For still wider jitter measurement bandwidth, INTERVU.AZ2 may be used. The DIO Panel jitter measurement bandwidth is set to the 50 Hz-100 kHz

range. The built-in loudspeaker and stereo headphone jack are set to monitor the imbedded audio of the digital input signal.

**Sweep and Display:** The FFT Freq selection at Source 1 provides a frequency domain (spectrum analysis) display. Start and Stop values of zero and 24 kHz display jitter components over that range. Note that the 24 kHz value will have to be changed to a value no higher than  $\frac{1}{2}$  the incoming sample rate when measuring interface signals with sample rates below 48 kHz. The Data 1 graph top and bottom are set for 0.1 UI (Unit Interval) and zero UI. The graph right mouse button menu Optimize command may be used after the spectrum analysis is graphed to better fit the display coordinates to the actual measured data.

## Waveform of jitter

---

### JIT-WAVE.AT2

**Purpose:** This test displays the waveform of the jitter on the digital input signal. Waveform display may help identify the major frequency components of the jitter signal, which helps lead to the source of the jitter.

**Stimulus:** Stimulus from System Two Cascade is not necessary for this test. It can be used to measure jitter on any AES/EBU or Consumer interface signal from any source. If a digital device with a real-time path from digital input to digital output is being tested and it is desired to drive it while measuring jitter, the Digital Generator output may be connected.

**Measurement:** The FFT Spectrum Analyzer DSP program (FFT.AZ2) acquires signal and performs the waveform display. The low-bandwidth A/D converter is used, fed from the Jitter Signal which is the error voltage from the digital input phase locked loop. The sample rate of the A/D is set to 48 kHz, providing bandwidth out to better than 20 kHz. If waveform display of jitter signals to 80 kHz is desired, the FFT Input selection should be changed to High Bandwidth. For jitter waveform display with still wider jitter measurement bandwidth, INTERVU.AZ2 may be used. The DIO Panel jitter measurement bandwidth is set to the 50 Hz-100 kHz range.

The built-in loudspeaker and stereo headphone jack are set to monitor the imbedded audio of the digital input signal.

**Sweep and Display:** The FFT Time selection at Source 1 provides a time domain (oscilloscope) display. Start and Stop values of zero and 100 milliseconds display jitter components over that range. The Data 1 graph top and bottom are set for  $\pm 0.1$  UI (Unit Interval). The graph right mouse button menu Optimize command may be used after the spectrum analysis is graphed to better fit the display coordinates to the actual measured data. The mouse cursor may be used to zoom in on certain time portions of the waveform, or values may be entered directly into the Source 1 Start and Stop fields to look at different portions of the record.

## Interface waveform & jitter

---

### INTF-JIT.AT2

**Purpose:** This test performs a dual-trace oscilloscope view of both the AES/EBU or Consumer digital input signal and of the jitter on that signal.

**Stimulus:** Stimulus from System Two Cascade is not necessary for this test. It can be used to display the waveform and jitter of any AES/EBU or Consumer interface signal from any source. If a digital device with a real-time path from digital input to digital output is being tested and it is desired to drive it while observing these signals, the Digital Generator output may be connected.

**Measurement:** The Digital Interface Analyzer DSP program (INTERVU.AZ2) acquires the digital input interface signal and performs the analysis. INTERVU acquires a long block (nearly four milliseconds) of interface signal, determines the average clock frequency over that period, and then compares actual transitions to the average clock to determine the jitter of each edge. Jitter Detection is set to All Bits on the INTERVU panel to cause a comparison to the clock at every data cell. INTERVU is set up to trigger on the first received Channel A preamble after F9 is pressed. System Two Cascade also recovers the jitter signal from the digital input phase locked loop

error voltage and routes this signal through a D/A converter to the built-in loudspeaker and headphone jack.

**Sweep and Display:** Source 1 is set to INTERVU Time, with Start and Stop values of 10 microseconds and 30 microseconds. This 20-microsecond span corresponds to approximately one frame of AES/EBU signal at a sample rate of 48 kHz. The portion of the record before 10 microseconds is not plotted since INTERVU does not compute and display jitter until the first preamble is found, which may be up to  $\frac{1}{2}$  frame into the record. Portions of the displayed span may be zoomed with the right mouse button for more detail, clearly showing the one UI, two UI, and (in preambles only) three UI pulses of the interface signal. Other portions of the record, out to about 3.9 milliseconds, may be viewed by entering the desired span into the Source 1 Start and Stop fields and pressing the F6 function key to send the data on the new span from System Two Cascade to the computer. The interface signal is plotted at Data 1 with a  $\pm 3$  volt scale which handles a typical 5 volt p-p AES/EBU signal amplitude. The jitter waveform is plotted at Data 2 with a  $\pm 10$  nanosecond range to handle up to 20 nanoseconds p-p of jitter. The graph right-hand mouse button Optimize commands may be used after an F9 or F6 operation to fit the graph coordinates (left, right, or both) to the actual measured jitter.

## Jitter histogram

---

### JIT-PROB.AT2

**Purpose:** This test plots a histogram (probability graph) of the rate of occurrence of different values of jitter in the 3.9 millisecond record acquired by INTERVU.

**Stimulus:** Stimulus from System Two Cascade is not necessary for this test. It can be used to display the jitter histogram of any AES/EBU or Consumer interface signal from any source. If a digital device with a real-time path from digital input to digital output is being tested and it is desired to drive it while observing these signals, the Digital Generator output may be connected.

**Measurement:** The Digital Interface Analyzer DSP program (INTERVU.AZ2) acquires the digital input interface signal and

performs the analysis. INTERVU acquires a long block (nearly four milliseconds) of interface signal, determines the average clock frequency over that period, and then compares actual transitions to the average clock to determine the jitter of each edge. Jitter Detection is set to All Bits on the INTERVU panel to cause a comparison to the clock at every data cell. The measured values of jitter at each transition, positive and negative, are counted into “bins”. The total number of counts in all the bins represents 100%. The count in each bin is then compared to the total and graphed with a Y-axis displacement calibrated as the probability of occurrence of that particular bin value during this acquisition. INTERVU is set up to trigger on the first received Channel A preamble after F9 is pressed. System Two Cascade also recovers the jitter signal from the digital input phase locked loop error voltage and routes this signal through a D/A converter to the built-in loudspeaker and headphone jack.

Sweep and Display: Intervu Jitter is selected at Source 1 and Intervu Probability at Data 1. The Source 1 Start and Stop values of  $\pm 10$  nanoseconds handle peak-to-peak jitter values up to 20 ns. The height and shape of the trace indicate how the various jitter magnitudes and signs were distributed. It is often desirable to check the Repeat checkbox near the bottom of the Sweep panel and press F9 or Go to get a constantly-updating series of histograms over a succession of acquisitions of the interface signal.

## Eye pattern

### **EYE-PAT.AT2**

Purpose: This test displays an eye pattern of the received AES/EBU or Consumer digital input signal. An eye pattern gives a quick indication of the general quality of a serial signal, providing information on amplitude, rise and fall time, noise, and jitter at a glance.

Stimulus: Stimulus from System Two Cascade is not necessary for this test. It can be used to display the eye pattern of any AES/EBU or Consumer interface signal from any source. If a digital device with a real-time path from digital input to digital output is being tested and it

is desired to drive it while observing the eye pattern, the Digital Generator output may be connected.

**Measurement:** The Digital Interface Analyzer DSP program (INTERVU.AZ2) acquires the digital input interface signal and performs the analysis. INTERVU acquires a long block (nearly four milliseconds) of interface signal and also determines the average clock frequency over that period. At a 48 kHz sample rate, this record length includes about 24,000 unit intervals of interface signal. In the Amplitude vs. Time field on the INTERVU panel, Eye Pattern is selected. Using the clock information, INTERVU divides the time axis of the entire acquisition into one-Unit-Interval-wide segments. All Unit-Interval-wide segments are then analyzed in small time increments across the Unit Interval to determine the nearest-to-zero amplitude of the worst segment at each time increment. In effect, it is as if each Unit Interval portion was a trace on a piece of transparent film and all the films were stacked on top of one another. By looking down through this stack of film, the innermost “envelope” is the eye pattern. The graph plotted thus shows the worst-case (nearest to zero amplitude) signal amplitude at each time slot relative to the start of the Unit Interval.

System Two Cascade also recovers the jitter signal from the digital input phase locked loop error voltage and routes this signal through a D/A converter to the built-in loudspeaker and headphone jack.

**Sweep and Display:** Source 1 is selected as INTERVU Time, with Start and Stop times of zero and 163 nanoseconds. This Stop time value is correct for 48 kHz sample rate signals and must be changed for other sample rates, in order to graph one Unit Interval (1/128 of a frame). The formula to compute one Unit Interval in nanoseconds is:

$7812.5 / R$  where R is the sample rate expressed in kHz.

Thus, one Unit Interval at 48 kHz is  $7812.5/48 = 162.76$  nanoseconds, one Unit Interval at 44.1 kHz is  $7812.5/44.1 = 177.15$  nanoseconds, and one Unit Interval at 96 kHz is 81.38 nanoseconds.

Data 1 is selected as INTERVU Upper Eye Opening and Data 3 as INTERVU Lower Eye Opening. The same color is selected for Data 1 and Data 3 traces, since together they make up one eye pattern. Using



Data 1 and 3 places both on the left-hand vertical axis so that manual scale changes or Optimizing will act on both halves of the eye pattern together. The Graph Top and Bottom values of  $\pm 3$  volts are set assuming a typical AES/EBU 5 volts p-p signal. The Optimize command of the graph right mouse button menu may be used to fit the graph to signals of other amplitudes, such as the typical one volt p-p signal of consumer devices.

## Testing Jitter Tolerance of a Digital Device

### JITTOLER.AT2

**Purpose:** This test sweeps jitter frequency and amplitude at the digital output according to a forthcoming revision of the AES3 recommendation, while measuring THD+N on the digital input signal to verify that the device under test functions properly with this range of jitter signal.

**Stimulus:** Two types of stimulus are involved; the imbedded digital audio signal, and controllable jitter on the digital interface signal. The imbedded audio signal is a full-scale sinewave of 3.456 kHz on both channels A and B. Amplitude and/or frequency of the imbedded signal can be changed as desired. Controlled, calibrated sinewave jitter is deliberately added to System Two Cascade's digital interface output signal. The "EQ Sinusoidal" jitter waveform is used in this test, with the equalization curve JITTOL.ADQ attached. The Jitter Amplitude is set to 1.00 Unit Intervals. With that value of jitter amplitude and the equalization curve, actual jitter amplitude added to the signal will be as high as 10.0 UI at low jitter frequencies (50-200 Hz) and as little as 0.25 UI at jitter frequencies above 8.0 kHz, varying inversely with frequency between 200 Hz and 8 kHz. This template of jitter amplitude versus frequency is specified in a forthcoming revision of the AES3 standard. An AES/EBU digital input device, to be judged of adequate quality, must accept all values of jitter amplitude and frequency below this template. The test is set up using the XLR balanced digital output signal, but the unbalanced BNC or the optical output connectors could be selected in the DIO Output Format field and used instead. Likewise, the XLR balanced input connector is selected but BNC or optical could be selected and used.

Measurement: THD+N of Channel A of the imbedded audio signal is measured by the Digital Analyzer and plotted as Data 1. The notch filter of the Digital Analyzer is steered by the Digital Generator frequency (DGen Track). If the device under test loses lock or has its performance degraded by the jitter, the measured THD+N will increase. Settling for the THD+N meter is turned off on the Sweep Settling panel, so even momentary problems should plot as transients. If the digital device under test has an analog output and no digital output, the Analog Analyzer in THD+N mode could be used instead. Data 2 plots the measured total jitter amplitude of the received digital interface signal. Average detection and the 50 Hz-100 kHz bandwidth are used.

Sweep and Display: Source 1 sweeps the frequency of sinewave jitter injected into the digital interface output signal from 50 Hz to 100 kHz. As noted above, jitter amplitude varies from 10 UI to 0.25 UI in accordance with the equalization curve. The measured distortion is plotted as Data 1 and ideally would be a flat horizontal line at a value determined by the dynamic range (word width) of the device, unaffected by the jitter frequency and amplitude sweep of Source 1. In fact, a transient just above 800 Hz is likely due to a frequency range switch in the phase-locked loop circuit of the DIO jitter generator. To test against limits without this transient, it may be necessary to set up two similar tests with one sweeping up to approximately 800 Hz jitter frequency and the other sweeping from about 850 Hz to 100 kHz. Data 2 plots the DIO panel measured total jitter from the digital input signal and Data 4 plots the post-EQ jitter amplitude setting of the DIO jitter generator. If the digital-to-digital device under test has unity jitter gain, the Data 2 and Data 4 plots will essentially lay on top of one another. Jitter gain or loss through the device will cause the Data 2 (measured) trace to plot above or below the Data 4 (settings) trace. If a device with no digital output is being tested, Data 2 should be disabled in addition to using the analog THD+N meter as described above.

## Summary of Furnished System Two Cascade Test Files

### Analog-to-Analog

(C:\APWIN\S2CASCADE\A-A)

Frequency response: A-A FRQ RESP.AT2C

Fast frequency response: A-A FRQ RESP FAST.AT2C

Noise (single point): A-A NOISE.AT2C

THD+N vs. frequency: A-A THD+N VS FREQ.AT2C

FFT of THD+N residuals:

A-A FFT OF THD+N RESIDUAL.AT2C

THD+N vs frequency, two channels simultaneous:

A-A THD+N VS FREQ 2CH.AT2C

THD+N vs. amplitude: A-A THD+N VS AMPL.AT2C

SMPTE IMD vs. amplitude: A-A SMPTE VS AMPL.AT2C

CCIF IMD vs. amplitude: A-A CCIF VS AMPL.AT2C

DIM IMD vs. amplitude: A-A DIM VS AMPL.AT2C

Interchannel phase vs. frequency:

A-A RELATIVE PHASE.AT2C

Input/Output phase: A-A IN-OUT PHASE.AT2C

Linearity: A-A LINEARITY.AT2C

Crosstalk vs. frequency: A-A XTALK.AT2C

FFT spectrum analysis: A-A FFT.AT2C

Waveform display: A-A VIEW WAVEFORM.AT2C

External frequency response: X-A FRQ RESP.AT2C

External THD+N vs. frequency: X-A THD+N VS FREQ.AT2C

Wow & flutter vs. time: A-A W&F VS TIME.AT2C

Locating -3 dB Point: A-A FIND MINUS 3DB.AT2C

Power Bandwidth: A-A PWR BANDWIDTH.AT2C

Multitone test suite of response, distortion, noise, stereo separation, and interchannel phase: A-A MULTITONE.APB, which calls A-A MULTI FRQ RESP.AT2C, A-A MULTI DISTORTION.AT2C, A-A MULTI NOISE.AT2C, A-A MULTI XTLK.AT2C, and A-A MULTI RELATIVE PHASE.AT2C.

Response of a Phonograph Preamplifier: A-A FRQ RESP RIAA.AT2C

### **Analog-to-Digital**

**(C:\APWIN\S2CASCADE\A-D)**

Frequency response: A-D FRQ RESP.AT2C

Fast frequency response: A-D FRQ RESP FAST.AT2C

Noise (single point): A-D NOISE.AT2C

THD+N vs. frequency: A-D THD+N VS FREQ.AT2C

THD+N vs. amplitude: A-D THD+N VS AMPL.AT2C

SMPTE IMD vs amplitude: A-D SMPTE VS AMPL.AT2C

SMPTE IMD (FFT): A-D SMPTE VS AMPL.AT2C

CCIF IMD (FFT): A-D CCIF FFT.AT2C

DIM IMD (FFT): A-D DIM FFT.AT2C

Interchannel phase vs. frequency (multitone):  
A-D RELATIVE PHASE.AT2C

Linearity: A-D LINEARITY.AT2C

Crosstalk vs. frequency: A-D XTALK.AT2C

FFT spectrum analysis: A-D FFT.AT2C

Waveform display: A-D VIEW WAVEFORM.AT2C

Multitone test suite of response, distortion, noise, stereo separation, and interchannel phase: A-D MULTITONE.APB, which calls A-D MULTI FRQ RESP.AT2C, A-D MULTI DISTORTION.AT2C, A-D MULTI NOISE.AT2C, A-D MULTI XTLK.AT2C, and A-D MULTI RELATIVE PHASE.AT2C.

## Digital-to-Analog

---

(C:\APWIN\S2CASCADE\D-A)

Frequency response: D-A FRQ RESP.AT2C

Fast frequency response: D-A FRQ RESP FAST.AT2C

Noise (single point): D-A NOISE.AT2C

THD+N vs. frequency: D-A THD+N VS FREQ.AT2C

THD+N vs frequency, two channels simultaneous:  
D-A THD+N VS FREQ 2CH.AT2C

FFT of THD+N residuals:  
D-A FFT OF THD+N RESIDUAL.AT2C

THD+N vs. amplitude: D-A THD+N VS AMPL.AT2C

SMPTE IMD vs. amplitude: D-A SMPTE VS AMPL.AT2C

CCIF IMD vs. amplitude: D-A CCIF-DFD VS AMPL.AT2C

DIM IMD vs. amplitude: D-A DIM VS AMPL.AT2C

Interchannel phase vs. frequency: D-A RELATIVE  
PHASE.AT2C

Linearity: D-A LINEARITY.AT2C

Crosstalk vs. frequency: D-A XTALK.AT2C

FFT spectrum analysis: D-A FFT.AT2C

Waveform display: D-A VIEW WAVEFORM.AT2C

Multitone test suite of response, distortion, noise, stereo separation, and interchannel phase: D-A MULTITONE.APB, which calls D-A MULTI FRQ RESP.AT2C, D-A MULTI DISTORTION.AT2C, D-A MULTI NOISE.AT2C, D-A MULTI XTLK.AT2C, and D-A MULTI RELATIVE PHASE.AT2C.

### Digital-to-Digital

---

(C:\APWIN\S2CASCADE\D-D)

Fast frequency response: D-D FRQ RESP FAST.AT2C

Dual connector frequency response:

D-D DUAL CONNECTOR FRQ RESP FAST.AT2C

Noise (single point): D-D NOISE.AT2C

THD+N vs. frequency: D-D THD+N VS FREQ.AT2C

THD+N vs. amplitude: D-D THD+N VS AMPL.AT2C

SMPTE IMD: D-D SMPTE VS AMPL.AT2C

CCIF IMD: D-D CCIF FFT.AT2C

DIM IMD: D-D DIM FFT.AT2C

Interchannel phase vs. frequency:

D-D RELATIVE PHASE.AT2C

Linearity: D-D LINEARITY.AT2C

Crosstalk vs. frequency: D-D XTALK.AT2C

FFT spectrum analysis: D-D FFT.AT2C

Waveform display: D-D VIEW WAVEFORM.AT2C

Bit errors with random noise signal: D-D BIT ERRORS  
RANDOM.AT2C

Bit errors and hex amplitude display with constant “waveform”  
sweep: D-D BIT ERRORS CONSTANT SWEEP.AT2C

Multitone test suite of response, distortion, noise, stereo separation,  
and interchannel phase: D-D MULTITONE.APB, which calls D-D  
MULTI FRQ RESP.AT2C, D-D MULTI DISTORTION.AT2C,  
D-D MULTI NOISE.AT2C, D-D MULTI XTLK.AT2C, and D-D  
MULTI RELATIVE PHASE.AT2C.

## Digital Interface Tests

---

(C:\APWIN\S2CASCADE\DIOANLYZR)

Total jitter vs. time: JIT-TIME.AT2

FFT of jitter: JIT-FFT.AT2

Waveform of jitter: JIT-WAVE.AT2

Interface waveform & jitter: INTF-JIT.AT2

Jitter histogram: JIT-PROB.AT2

Eye pattern: EYE-PAT.AT2

Testing Jitter Tolerance of a Digital Device: JITTOLER.AT2





# 27 Index



- %FS units 18-7
- +Normal regulation algorithm 3-30
- Normal regulation algorithm 3-30
- .AAM file 3-17, 14-29, 15-22, 16-15
- .AAS file 3-17, 14-29, 15-22, 16-15
- .ADA file 3-17
- .ADL file 3-17
- .ADL limit files
  - Creating 21-1
- .ADS file 3-17
- .ADS sweep files
  - Creating 21-1
- .ADX (export) files 3-12
- .ADX file 3-17
- .AGM file 3-17
- .AGS file 3-17
- .ALG file 3-17
- .APB file 3-17
- .AT1 file 3-17
- .AT2 file 3-17
- .AT2 vs .AT2C test file extension 3-6
- .AZ1 file 3-17
- .AZ2 file 3-17
- 2-Sigma 22-8

- 50/15 microsecond deemphasis 7-5
- 50/15 microsecond preemphasis 7-9

## A

- A to B offset
  - Switchers 24-4
- A/D converters in System Two 6-3
- A/D sample rate, FASTTEST 15-5
- A/D sample rate, FFT 14-2
- A/D sample rates, analyzer 11-3
- About APWIN 3-53
- Absolute values function, FFT 14-20
- AC amplitude units 18-1
- AC coupling, analog analyzer 5-3
- AC coupling, FFT 14-12
- Acceptance limits
  - Attaching 21-9
  - Creating 21-7
- Acquisition buffer 13-6
  - Saving 14-30, 15-23
- Acquisition buffer length, FFT 14-5
- Acquisition Triggering Section (FFT) 14-23
- Adding new data to old 3-33
- Address settings
  - Switcher 24-14

- AES/EBU error flags 8-8
- AES/EBU input word strobe 9-8
- AES/EBU Reference Output 17-6
- AES/EBU sample rate clock 9-8
- AES/EBU sync 17-3
- AES/EBU/EIAJ input termination resistance 8-10
- Algorithm
  - Settling 19-29
- Algorithms, regulation function 3-29
- All channels driven
  - Switcher 24-3
- Alt+F6 3-35
- Alt+F6 re-process without new FFT 13-11
- Alt+F9 3-34
- Amplitude control and units, digital generator 10-19
- Amplitude error
  - Blackman-Harris window 14-8
  - Hann window 14-7
- Amplitude error (FFT)
  - Minimum 14-9
- Amplitude function, reading meter 5-7
- Amplitude measurement error, FFT vs. FASTTEST 14-12
- Amplitude measurements, DSP analyzer 11-7
- Amplitude probability, interface signal 8-43
- Amplitude tracking between channels, analog generator 4-26
- Amplitude tracking between digital generator channels 10-19
- Amplitude units 18-1
  - DCX-127 18-8
- Ampstep, APWIN equivalent 20-21
- Analog analyzer 3-20
  - Analog analyzer auto vs. fixed range concepts 5-31
  - Analog analyzer bandpass filter sweeps 5-21
  - Analog analyzer bandpass/bandreject filter hardware 5-28
  - Analog analyzer dBr references 5-21
  - Analog analyzer detector hardware 5-30
  - Analog analyzer detector type selection 5-19
  - Analog analyzer frequency counters 5-4
  - Analog analyzer frequency meter hardware 5-27
  - Analog analyzer hardware overview 5-23
  - Analog analyzer input configuration 5-24
  - Analog analyzer input source selection 5-3
  - Analog analyzer Level meter hardware 5-26
  - Analog analyzer option filter control 5-20
  - Analog analyzer panel 5-1
  - Analog analyzer phase meter hardware 5-26
  - Analog analyzer reading meter hardware 5-27
  - Analog analyzer reference frequency 5-23
  - Analog bandpass/bandreject filter hardware 5-28
  - Analog generator accuracy and resolution 4-25
  - Analog generator dBr reference 4-30
  - Analog generator frequency 4-24
  - Analog generator hardware overview 4-31
  - Analog generator output channel selection 4-25 - 4-26

- Analog generator output configuration 4-27
- Analog generator output on-mute control 4-25
- Analog generator output stage 4-34
- Analog Generator panel 4-1
- Analog generator reference frequency 4-30
- Analog input, DSP Audio Analyzer 11-3
- Analog vs. digital source selection, MLS 16-14
- Analog waveforms 4-2
- Analog/digital input selection, FASTTEST 15-5
- Analog/digital input selection, FFT 14-2
- Analog/digital input selection, MLS 16-5
- Analyzer (analog) auto vs fixed range concepts 5-31
- Analyzer (analog) bandpass/bandreject filter hardware 5-28
- Analyzer (analog) dBr references 5-21
- Analyzer (analog) detector hardware 5-30
- Analyzer (analog) detector type selection 5-19
- Analyzer (analog) frequency counters 5-4
- Analyzer (analog) frequency meter hardware 5-27
- Analyzer (analog) highpass filter control 5-19
- Analyzer (analog) input configuration 5-24
- Analyzer (analog) input ranging 5-4
- Analyzer (analog) input source selection 5-3
- Analyzer (analog) Level meter hardware 5-26
- Analyzer (analog) low pass filter selection 5-19
- Analyzer (analog) overview 5-23
- Analyzer (analog) panel 5-1
- Analyzer (analog) phase meter hardware 5-26
- Analyzer (analog) reading meter hardware 5-27
- Analyzer (analog) reference frequency 5-23
- Analyzer channel selection 5-6
- Analyzer dBm reference 5-22
- Analyzer option filter control 5-20
- Analyzer overview, digital 7-9
- Analyzer phase meter ranges 5-5
- Analyzer reading rate control 5-18
- ANALYZER sweep settings and readings 11-17
- Analyzer Watts reference 5-22
- ANALYZER.AZ2 11-1
- Append data 3-11
- Appending to sweep 3-33
- Applications for regulation function 3-31
- Apply after sweep 22-2
- APWIN file types 3-17
- APWIN main workspace 2-2
- APWIN menu bar 2-1
- APWIN screen 2-1
- APWIN status bar and tabs 2-2
- APWIN toolbar 2-3
- Arbitrary step size, generators 20-21
- Arbitrary waveform (analog) sample rate 4-4
- Arbitrary waveform files
  - Creating 15-26
- Arbitrary waveform sample rate, setting when loading generator 3-41

- Arrange icons 3-51
- ASCII data export 21-6
- AT1 or AT2 file name, printing 20-27
- Attached File Editor 19-15, 21-10
- Attaching limit files to tests 21-9
- Audible monitoring 3-24
- Audio frequency measurements, scaling 7-5
- Audio level monitors, digital signals 7-6
- Audio Precision in graph title bar 3-42
- Auto phase ranges 5-5
- Auto smoothing 22-4
- Auto/fixed range checkbox
  - DCX-127 25-2
- Automatic Ctrl+F6 on zoom 3-40, 13-11
- Automatic F7 on opening test 3-40
- Automatic graphing of data when test is opened 3-40
- Automatic instrument detection at APWIN startup 3-38
- Automatic sequence of compute operations 22-2
- Automatic start with last test loaded 3-39
- Automatic termination of external sweeps 19-11
- Autorange vs. fixed range concepts 5-31
- Autorange, DSP analyzer reading meter 11-10
- Autoranging of reading meter 5-17
- Autoranging, analyzer inputs 5-4
- Autoscale
  - Graph vertical 19-17
- Average (Compute 22-9
- Average instead of settling 19-29
- Averaging, FFT 14-14
- Averaging, synchronous (time domain) 14-16

- Avoiding A/D converter overload, FASTTEST 15-8
- Avoiding A/D converter overload, FFT 14-5

## B

- B to A offset
  - Switchers 24-4
- Back termination selection 4-29
- Balanced input termination 5-3
- Balanced Inputs 5-25
- Balanced-unbalanced selection, analog generator 4-27
- Bandpass filter sweeps, analog 5-21
- Bandpass function, DSP analyzer 11-9
- Bandpass function, reading meter 5-7
- Bandpass-bandreject filter steering control and manual frequency entry field 5-21
- Bandpass/Bandreject Filter Tuning (ANALYZER) 11-10
- Bandpassed noise waveform 4-21
- Bandreject function, reading meter 5-7
- Bandwidth control, analog analyzer 5-19
- Bandwidth limiting, analog analyzerThe Reading Meter includes selectable three-pole (18 dB/octave) high-pass filters at 5-19
- Bandwidth, interface signal 8-34
- Bar graph max/min reset 3-20
- Bargraph target range 20-20
- Bargraph, readings 20-20
- Bargraph, settings 20-20
- Bargraphs 20-18
- Bargraphs, copying to clipboard 3-19
- BH4 (Blackman Harris) FFT window 14-8
- Bin width

- FFT 13-5
  - Binary control for ports A, B, C 25-5
  - Bins (FFT) vs. displayed points 13-9
  - Bit error rate analyzer 12-1
  - Bits (units) 18-7
  - Bits of input word width 7-4
  - BITTEST 12-1
  - BITTEST random waveform 10-15
  - Black trace on color printers 20-30
  - black vs white background, graph 3-19
  - Blackman-Harris FFT window 14-8
  - Bounds for linearity testing 22-5
  - BP-BR Filter steering 5-21
  - Browser 2-10
  - Browser settings and readings, ANALYZER 11-17
  - Burn-in mode
    - Switcher 24-3
  - Burst
    - Triggered 4-8
  - Burst length for multitone triggering 15-16
  - Burst signals, spectrum analysis 14-22
  - Burst, shaped 4-14, 10-5
  - Bursts
    - Gated 4-9
  - By varying, regulation function 3-29
- C**
- Cable simulation, digital output 8-16
  - Calibrating digital generator for D/A testing 10-21
  - CCIF IMD 4-15, 5-10, 10-10
  - CCITT J17 deemphasis 7-5
  - CCITT J17 preemphasis 7-9
  - CD preemphasis 7-9
  - Cell edge triggering, INTERVU 8-29
  - Cent units 18-6
  - Centering data between limits 22-6
  - Chaining compute operations 22-2
  - Changing company name in graph title bar 3-42
  - Changing frequency, analog generator 4-24
  - Changing page views of main workspace 2-2
  - Channel 2 Phase Display (FASTTEST) 15-21
  - Channel amplitude tracking, digital generator 10-19
  - Channel invert, analog generator 4-26
  - Channel level monitors, digital signals 7-6
  - Channel polarity inversion, digital generator 10-19
  - Channel range selection
    - Switcher 24-14
  - Channel selection, analog generator outputs 4-25 - 4-26
  - Channel selection, digital generator 10-18
  - Channel selection, FASTTEST 15-6
  - Channel selection, FFT 14-3
  - Channel selection, MLS 16-6
  - Channel status byte display 8-49
  - Channel status byte hexadecimal display 8-50
  - Channel status byte output selection 8-48
  - Channel status bytes panel 8-46
  - Channel tracking, analog generator 4-26
  - Channel-selected signal
    - DCX-127 25-11
  - Chart recorder mode 19-12

- Checking limits after compute 22-2
- Choosing analog waveforms 4-2
- Clear All (Compute) 22-11
- Clear log file 3-50
- Clipboard
  - Copy to 3-18
  - Paste from 3-19
- Close all windows 3-51
- CMRR test mode, analog generator 4-27
- CODEC equivalent in System Two 15-4
- Coding error flag 8-8
- Combining waveform files 14-31, 15-24, 16-16
- Comments under graph 20-9
- Common mode output signal 8-16
- Common mode test mode selection, analog generator 4-27
- Compunder settling with multitone testing 15-16
- Company name in graph title bar 3-42
- Company name replacement 3-38
- Compare data to limits 3-36
- Compatibility mode and test file extension 3-6
- Compute 2-Sigma 22-8
- Compute and Close button 22-2
- Compute Average 22-9
- Compute before limit check 22-2
- Compute button 22-2
- Compute center 22-6
- Compute Clear All 22-11
- Compute Delta 22-7
- Compute invert 22-4
- Compute linearity 22-5
- Compute Maximum/Minimum 22-10
- Compute menu 22-1
- Compute normalize 22-3
- Compute operations in sequence 22-2
- Compute smooth 22-4
- Computed and original data, viewing 22-2
- Concepts
  - FFT windows 13-8
- Confidence flag 8-8
- Configuration selection analog generator 4-27
- Configuration utility 3-38
- Configuration, analog analyzer input 5-24
- Connector
  - parallel i/o 9-2
- Connector selection, analog analyzer 5-3
- Connector selection, digital input 7-3, 8-7
- Connector selection, digital output 7-8, 8-13
- Constant (digital DC) waveform & BITTEST 12-2
- Constant “waveform”, digital 10-15
- Continuous sweep 19-7
- Continuous sweeps 3-34
- Control bargraph 20-20
- Control input
  - Digital (DCX-127) 25-9
- Control of devices via DCX-127 25-5
- Control of tone bursts 4-6, 10-4
- Control of wow & flutter measurements 5-12
- Control voltage output 25-8
- Controlled parameter, regulation function 3-29
- Controls, analog analyzer 5-1
- Converter overload, FASTTEST 15-8
- Converter overload, FFT 14-5
- Copy graph to clipboard 3-19
- Copy panel to clipboard 3-19

- Copy to clipboard 3-18
  - Copy to sweep panel 20-5
  - Counter (frequency) hardware 5-27
  - Creating limit and sweep files with data editor 21-1
  - Creating limits 21-7
  - Creating multitone waveform files 15-26
  - Cross-reference from test to limit file 21-9
  - Crosstalk function, reading meter 5-17
  - Crosstalk measurement, multitone waveforms for 15-33
  - Crosstalk, DSP analyzer 11-8
  - Ctrl+F6 on zoom 3-40, 13-11
  - Ctrl+F9 3-33
  - Current directory, setting 3-10
  - Cursors 20-6
  - Cut 3-18
- D**
- D/A converters in System Two 6-3
  - D/A sample rate 4-4
  - D/A sample rate, setting correct value for waveform file 3-41
  - Data
    - Retaining sweep to sweep 19-8
  - Data 3-6 plotting 19-18
  - Data bits 7-7
  - Data editor and legend interaction 20-16
  - Data editor usage to create files 21-1
  - Data editor-legend interaction 21-2
  - Data export 3-12
  - Data files for limits
    - Creating 21-7
  - Data format selection
    - DCX-127 digital input 25-4
    - DCX-127 digital output 25-4
  - Data invalid flag 8-8
  - Data on X axis
    - Plotting 19-22
  - Data parameters, FASTTEST 15-19
  - Data parameters, FFT 14-26
  - Data valid bit 8-8
  - dB units 18-3, 18-5
  - dBFS units 18-7
  - dBg units 18-3
  - dBm reference, analyzer 5-22
  - dBm reference, generator 4-29
  - dBm units 18-3
  - dBm vs. dBu concepts 18-4
  - dBr Reference
    - Analog analyzer setting 3-20
    - Setting generator 3-20
  - dBr Reference, analog generator 4-30
  - dBr references, analog analyzer 5-21
  - dBr units 18-4
  - dBr1 digital reference 14-26, 15-19
  - dBr1 reference, ANALYZER 11-17
  - dBr2 digital reference 14-26, 15-19
  - dBr2 reference, ANALYZER 11-17
  - dBu units 18-3
  - dBu vs. dBm concepts 18-4
  - dBUI 18-8
  - dBV units 18-4
  - DC “waveform”, digital 10-15
  - DC coupling, analog analyzer 5-3
  - DC output 1 and 2 on/off controls 25-3
  - DC output 1 and 2 value controls 25-3
  - DC plus sinewave, digital domain 10-7
  - DC voltage measurement 11-3
  - DC voltage measurements 25-7
  - DC voltage outputs 25-6, 25-8
  - DC Volts measurements 25-6

- DC Volts reading rate 25-3
- DC Volts units 25-2
- DCV/Ohms/off selection 25-3
- DCX-127
  - Autoranging 25-2
  - Dc output control 25-3
  - DC voltage outputs 25-8
  - Delayed sweep gate control 25-6
  - Digital control output ports 25-14
  - Digital input 25-9
  - Digital input format selection 25-4
  - Digital output 25-10
  - Digital output and units 25-4
  - Digital output data format selection 25-4
  - Digital output scale factor 25-5
  - Panel 25-1 - 25-4
  - Program control outputs 25-11
  - Range fixing 25-2
  - Resistance measurements 25-7
  - Voltage measurements 25-7
- DCX-127 amplitude units 18-8
- DCX-127 digital input units 18-8
- DCX-127 multi-function module 25-6
- De-glitchers, clocking 9-5
- Decade units 18-6
- Deemphasis, digital 7-5
- Degree units 18-7
- Delay
  - Settling 19-30
- Delay control
  - DCX-127 sweep gate 25-6
- Delay from ref out 17-6
- Delay measurement between input and generator output 8-11
- Delay measurement, input to reference 17-5
- Delayed gate output
  - DCX-127 25-11
- Delta 22-7
  - Delta frequency units 18-6
  - Delta Source 22-8
  - Destination code, transmitting 8-48
  - Detector control, analog analyzer 5-19
  - Detector hardware, reading meter 5-30
  - Detector reading rate, DSP analyzer 11-13
  - Deviation from perfect linearity 22-5
  - DFD (CCIF) test signals, analog 4-16 - 4-17
  - Diagnostic panel 3-27
  - Difference between two data sets 22-7
  - Digital analyzer overview 7-9
  - Digital control input 25-9
  - Digital control output ports
    - DCX-127 25-14
  - Digital control outputs 25-6, 25-10
  - Digital DC “waveform” 10-15
  - Digital domain amplitude units 18-7
  - Digital domain deemphasis 7-5
  - Digital domain frequency measurement 11-6
  - Digital domain measurement functions 11-6
  - Digital domain phase measurements 11-10
  - Digital generator channel amplitude tracking 10-19
  - Digital generator frequency control and units 10-18
  - Digital generator output amplitude and units 10-19
  - Digital generator output channel selection 10-18
  - Digital generator output on/off 10-19
  - Digital generator output polarity 10-19



- Digital generator panel 10-1
- Digital generator reference frequency 10-21
- Digital generator Volts/FS reference 10-21
- Digital generator waveform selection 10-2
- Digital Hardware Overview 6-1
- Digital I/O panel 8-3
- Digital input (low speed)
  - DCX-127 25-9
- Digital input connector and format selection 7-3, 8-7
- Digital input data format selection 25-4
- Digital input display and units selection 25-4
- Digital input error flags 8-8
- Digital input scaling
  - DCX-127 25-4
- Digital input, DSP Audio Analyzer 11-3
- Digital interface analyzer (INTERVU) 8-19
- Digital interface panel 8-3
- Digital level monitors 7-6
- Digital multi-meter units 25-2
- Digital multimeter function selection 25-3
- Digital output (low speed)
  - DCX-127 25-10
- Digital output and units
  - DCX-127 25-4
- Digital output connector/format 7-8, 8-13
- Digital output control
  - DCX-127 25-5
- Digital output data format selection
  - DCX-127 25-4
- Digital output pulse amplitude 8-14
- Digital output rise/fall time 8-15
- Digital output scale factor
  - DCX-127 25-5
- Digital References (FFT) 14-26, 15-19
- Digital units
  - DCX-127 18-8
- Digital Volts 10-21
- Digital vs. analog source selection, MLS 16-14
- Digital/analog input selection, FASTTEST 15-5
- Digital/analog input selection, FFT 14-2
- Digital/analog input selection, MLS 16-5
- DIM IMD 4-15, 5-10, 10-10
- DIN IMD 4-15, 5-9, 10-10
- DIN IMD, DSP Audio Analyzer 11-9
- DIO panel 8-3
- Disabling meter readings during sweeps 3-38
- Disc player
  - Sweeping from 19-8
- Disk files
  - Waveform 14-29, 15-22, 16-15
- Display samples function, FFT 14-20
- Displayed points vs. FFT bins 13-9
- Displaying limit files and sweep tables 21-10
- Displaying log files 3-50
- Displaying panels 3-23
- Displaying up to six parameters 19-23
- Displays, analog analyzer 5-1
- Distortion (harmonic) measurements 5-8
- Distortion function, FASTTEST 15-8
- Dither 10-20
- Dither tutorial 10-20

- Dither type 10-20
  - Divisions
    - X axis 19-5
    - Y axis 19-17
  - DMM function control 25-3
  - DMM function of Volts, Ohms 25-3
  - DMM reading rate 25-3
  - DMM units 25-2
  - Downloaded waveforms, freq error correction 15-26
  - Downloading waveforms 14-31, 15-25, 16-16
  - Dragging toolbar 2-3
  - DSP
    - parallel input 9-2
    - parallel output 9-4
    - parallel port 9-1
    - parallel port pin assignments 9-2
  - DSP analyzer reading rate 11-13
  - DSP analyzer weighting filters 11-15
  - DSP analyzer, THD+N measurements 11-9
  - DSP Architecture Overview 6-1
  - DSP audio analyzer 11-1
  - DSP Audio Analyzer weighting filter frequencies vs sample rate 11-16
  - DSP audio analyzer, level monitors 11-5
  - Dual connector operation 6-4, 7-1
  - Dynamic range, FFT vs. FASTTEST 14-12
- E**
- Edit menu 3-18 - 3-20
  - Editing limit files 21-10
  - Editing sweep tables 19-15, 21-10
  - Editor
    - Procedure 3-27
  - Emergency turn-off of generators 3-50
  - End On value
    - External sweeps 19-11
  - Ending APWIN session 3-16
  - Equalization via Compute Delta 22-7
  - Equalized sinewave sweep, digital 10-7
  - Equiripple window 14-9
  - Equivalent input circuit, balanced 5-25
  - Equivalent input circuit, unbalanced 5-26
  - Erasing log files 3-50
  - Erasure of old data
    - Sweeps 19-8
  - Erroneous waveform displays due to graphic aliasing 13-4
  - Error (bit) display 12-4
  - Error files
    - Clearing 3-50
    - Displaying 3-50
  - Error flag displays 8-8
  - Error logging 3-43
  - Error, No Compute Performed 22-1
  - Esc 3-33
  - EURZ option 3-41
  - Exiting APWIN 3-16
  - Exponential settling 19-29
  - Export (file) 3-12
  - Export ASCII Data 3-12
  - Extensions
    - File 3-17
  - External single-point sweep 19-6
  - External stereo sweeps 19-21
  - External sweeps 19-8
    - Automatically terminating 19-11
    - Minimum signal level 19-10
    - Step spacing 19-11
  - External time sweeps 19-12
  - Eye patterns (INTERVU) 8-39

**F**

- F/R units 18-6
- F6 3-34
- F6 Re-transform 13-10
- F7 3-36
- F7 automatic on opening test 3-40
- F9 3-33, 19-7
- Failure to plot
  - External sweeps 19-10
- False waveform displays due to graphic aliasing 13-4
- Fast RMS detector 11-14
- Fast sweeps 11-14
- Fast-high accuracy modes 4-25
- FASTTRIG equivalent in System Two 15-4
- FFS units 18-7
- FFT
  - Re-transforming 3-34, 13-10
- FFT after analog notch filter 14-4
- FFT Averaging (FFT) 14-14
- FFT dynamic range 14-12
- FFT fundamental concepts 13-5
- FFT Length (FASTTEST) 15-13
- FFT of wow & flutter 5-16
- FFT selectivity (window concepts) 13-8
- FFT spectrum analysis of interface signal (INTERVU) 8-34
- FFT spectrum analysis of jitter signal (INTERVU) 8-36
- FFT spectrum analyzer (FFT) 14-1
- FFT window 13-7
- FFT window shape selection 14-7
- FFT windowing concepts 13-8
- File append 3-11
- File browser 2-10
- File exit 3-16
- File export 3-12
- File import 3-15
- File length
  - Waveform files 14-30, 15-23
- File menu 3-1 - 3-17
- File new 3-1
- File open 3-1
- File page setup 3-16
- File print 3-16
- File print preview 3-16
- File print setup 3-16
- File recent file 3-16
- File save as 3-7
- File save procedure 3-6
- File save test 3-6
- File Set Working Directory 3-10
- File types 3-17
- File, print to 20-34
- Files
  - Waveform 14-29, 15-22, 16-15
- Filter frequency control, reading meter 5-21
- Filter hardware, bandpass/bandreject 5-28
- Filter selection, analog analyzer 5-19
- Filter steering, DSP analyzer 11-10
- Filter sweeps, analog analyzer 5-21
- Filters (utilities menu) 3-49
- Final production test report (log file) 3-43
- Finding -3 dB frequency of a filter 3-27
- Finding average value 22-9
- Finding maximum/minimum value 22-10
- Fitting straight line to data 22-5
- Fixed input range, DSP Audio Analyzer 11-6

- Fixed range selection field
  - DCX-127 25-2
- Fixed range, reading meter 5-17
- Fixed ranges, analyzer inputs 5-4
- Fixed ranges, DSP analyzer reading meter 11-10
- Fixed sensitivity vs fixed level trigger, FFT 14-24
- Fixed vs. autorange concepts 5-31
- Fixing BP-BR filter frequency 5-21
- Fixing ranges
  - DCX-127 25-2
- Flags, error 8-8
- Flat settling 19-29
- Flat-top FFT window 14-9
- Floating toolbar 2-3
- Floor
  - Sweep settling 19-29
- Flutter measurement control 5-12
- Flutter meter overview 5-11
- Following channel A amplitude, digital generator 10-19
- Format selection, digital input 7-3, 8-7
- Format selection, digital output 7-8, 8-13
- Frame lock, AES/EBU 17-4
- Freqstep, APWIN equivalent 20-21
- Frequency (ANALYZER) 11-6
- Frequency accuracy, analog generator 4-25
- Frequency change minimum value
  - External sweeps 19-11
- Frequency control and units, analog generator 4-24
- Frequency control and units, digital generator 10-18
- Frequency control, BP-BR Filter 5-21
- Frequency counters, analog 5-4
- Frequency error correction on
  - downloaded files for sound cards 15-26
- Frequency error correction to nearest bin center 14-10
- Frequency measurement, sync input 17-5
- Frequency measurements of imbedded digital audio signal, scaling 7-5
- Frequency meter hardware 5-27
- Frequency reference, analog analyzer 5-23
- Frequency reference, analog generator 4-30
- Frequency reference, ANALYZER 11-17
- Frequency reference, digital generator 10-21
- Frequency relative units
  - Setting analyzer reference 3-20
- Frequency Resolution (FASTTEST) 15-12
- Frequency resolution vs triggering 15-12
- Frequency resolution, analog generator 4-25
- Frequency settling speed, analog generator 4-25
- Frequency units 18-6
- Frequency, sync input 17-4
- Frequency-selective amplitude measurement 5-7
- Full-scale vs. Volts, digital generator 10-21
- Function of DC Volts 25-2
- Function of Ohms 25-2
- Function of Ohms units 18-8
- Function of Volts units 18-8
- Function of X scale factor
  - DCX-127 25-4
- Function selection, reading meter 5-6

**G**

- Gain measurements on analog devices 5-16
- Gain measurements, DSP analyzer 11-7
- Gain range control, reading meter 5-17
- Gate delay control for delayed trigger DCX-127 25-6
- Gaussian window 14-9
- Gen sync trigger, FFT 14-23
- Generating random and pseudorandom noise 4-19
- Generating squarewaves 4-18, 10-9
- Generation of noise signals 4-19
- Generator (analog) channel amplitude tracking 4-26
- Generator (analog) dBr reference 4-30
- Generator (analog) frequency 4-24
- Generator (analog) output configuration 4-27
- Generator (analog) output on-off 4-25
- Generator (analog) output stage 4-34
- Generator (analog) overview 4-31
- Generator (analog) reference frequency 4-30
- Generator (analog) waveform selection 4-2
- Generator (digital) amplitude control and units 10-19
- Generator (digital) delay from reference 17-6
- Generator (digital) frequency control and units 10-18
- Generator (digital) frequency reference 10-21
- Generator (digital) output channel selection 10-18
- Generator (digital) output on/off 10-19
- Generator (digital) output polarity inversion 10-19
- Generator (digital) panel 10-1
- Generator (digital) Volts/FS Reference 10-21
- Generator (digital) waveform selection 10-2
- Generator impedance selection 4-29
- Generator off 3-50
- Generator output channel selection (analog) 4-25 - 4-26
- Generator panel, analog 4-1
- Generator to input delay measurement 8-11
- Generator Watts unit reference 4-30
- Go Button 19-7
- Graph
  - Plotting more than 2 lines 19-18
  - Turning off 19-23
- Graph autoscale 19-17
- Graph comments 20-9
- Graph data on test open 3-38
- Graph data when test opened 3-40
- Graph export, vector 3-14
- Graph features
  - Keyboard control 20-17
- Graph legend 20-10
- Graph line styles 20-13
- Graph print preview 20-32
- Graph printing 20-24
- Graph printing setup 20-25
- Graph printing setups, saving and loading 20-31
- Graph title and labels 20-8
- Graph title bar
  - Company name 3-42
- Graph trace colors 20-11
- Graph vertical autoscale 19-17

Graph X-axis control 19-3 - 19-5  
 Graphic aliasing 13-4  
 Graphic aliasing, avoiding with FFT  
 14-20  
 Graphing existing data 3-36  
 Graphing swept measurements 19-1 -  
 19-32  
 Graphs, copying to Windows clipboard  
 3-19  
 Gray prints as black 20-30  
 Grid lines  
 X axis 19-5  
 Y axis 19-17

## H

Halting sweeps 3-33  
 Hamming window 14-9  
 Hann FFT window 14-7  
 Hardware  
 DSP 6-1  
 Hardware restore 3-37  
 Hardware status utility 3-38  
 Hardware, analog analyzer input  
 configuration 5-24  
 Hardware, analog bandpass/bandreject  
 filter 5-28  
 Hardware, analog generator output stage  
 4-34  
 Hardware, auto vs fixed range concepts  
 5-31  
 Hardware, frequency meter 5-27  
 Hardware, Level meters 5-26  
 Hardware, phase meter 5-26  
 Hardware, reading meter detectors 5-30  
 Hardware, reading meter overview 5-27  
 Harmonic tracking filter, DSP analyzer  
 11-17  
 Headphone/speaker panel 3-24

Headroom, preemphasis 7-9  
 Help  
 How to use 3-52  
 Help menu 3-51 - 3-54  
 Help with procedure language 3-52  
 Hexadecimal display of digital audio  
 amplitude 12-4  
 Hexadecimal transmit and receive 8-50  
 High frequency filters, DSP analyzer  
 11-13  
 High level setting of output status bytes  
 8-48  
 High level status byte display 8-49  
 High resolution A/D converters 11-4  
 High resolution A/D, FASTTEST 15-5  
 High resolution A/D, FFT 14-2  
 Highpass filters, DSP Audio Analyzer  
 11-12  
 Histogram of interface jitter 8-44  
 Histogram, interface signal amplitude  
 8-43  
 Histogram, interface signal pulse width  
 8-41  
 Holding constant distortion at device  
 output 3-27  
 HOR-AXIS 19-22  
 Horizontal value, Compute Normalize  
 22-3  
 How to use Help 3-52  
 HPGL file, printing to 20-34

## I

Imbedded audio signal level monitors  
 7-6  
 IMD measurements 4-15, 5-9, 10-10  
 IMD product spectrum analysis 14-3  
 Impedance (European Broadcast)  
 changes 3-41

- Impedance selection, generator 4-29
- Impedance, sync input 17-4
- Import (file) 3-15
- Importing .AT1 test files for use with System Two 3-3
- In to out offset
  - Switchers 24-4
- Independent variable 19-3 - 19-5
- Index
  - Help 3-52
- Input channel
  - Switcher 24-2
- Input channel selection 5-6
- Input channel status byte display 8-49
- Input configuration, analog analyzer 5-24
- Input connector selection, digital 7-3, 8-7
- Input delay measurement 17-5
- Input delay measurement from generator output 8-11
- Input delay measurement vs. reference input 17-5
- Input frequency measurement, sync 17-5
- Input impedance, sync connector 17-4
- Input range selection, DSP Audio Analyzer 11-6
- Input ranging control and manual selection 5-4
- Input resolution 7-4
- Input sample rate measurement 8-10
- Input selection (FASTTEST) 15-5
- Input selection (FFT) 14-2, 16-5
- Input source selection, analog analyzer 5-3
- Input switcher 24-10
- Input switcher control 24-1
- Input sync frequency 17-4
- Input termination 5-3
- Input termination impedance, AES/EBU 8-10
- Input voltage measurement, digital inputs 8-11
- Input voltmeters, analog 5-4
- Input word width display 7-7
- Input/output digital panel 8-3
- Installing filters 3-49
- Instrument panels
  - Displaying 3-23
- Instrument selection
  - Sys One vs. Sys Two 3-38
- Interchannel phase, FASTTEST 15-21
- Interface error pre-trigger 8-29
- Interface jitter probability 8-44
- interface rate histograms 8-42
- Interface rise and fall time measurement 8-35
- Interface signal probability vs. amplitude (INTERVU) 8-43
- Interface signal probability vs. pulse width (INTERVU) 8-41
- Interface spectrum analysis 8-34
- Interface waveform display 8-35
- Intermodulation distortion measurements 4-15, 5-9, 10-10
- Intermodulation distortion measurements, digital & analog 11-9
- Interpolate function, FFT 14-20
- Invalid flag 8-8
- Invert AES/EBU polarity 8-15
- Invert transmit frame sync 17-6
- Inverting analog generator output polarity 4-26
- Inverting data 22-4
- Inverting digital generator output polarity 10-19

**J**

J-test waveform 10-14  
 Jitter measurement 8-11  
 Jitter probability vs. amplitude (INTERVU) 8-44  
 Jitter spectrum analysis 8-36  
 Jitter spectrum analysis, FFT 14-3  
 Jitter test waveform 10-14  
 Jitter waveform (INTERVU) 8-38  
 Jitter, adding to master clock out 17-7

**K**

K Burst control 4-6, 10-4  
 K Gated bursts 4-9  
 K Main workspace 2-2  
 K Toolbar 2-3  
 K Triggered bursts 4-8  
 Keep readings active during sweeps 3-38  
 Keyboard control of graph features 20-17

**L**

L minus R, analog generator 4-26  
 Last file 3-16  
 LAST test save and load 3-39  
 Legend  
   Keyboard control 20-17  
 Legend and data editor interaction 20-16  
 Legend, graph 20-10  
 Legend-data editor interaction 21-2  
 Level meter hardware 5-26  
 Level meters, analog 5-4  
 Level Monitor (ANALYZER) 11-5  
 Level monitors 7-6  
 Level Monitors (FASTTEST) 15-8

Level Monitors (FFT) 14-5  
 Level units 18-1  
 Life-test mode  
   Switcher 24-3  
 Limit files, editing 21-10  
 Limiter settling with multitone testing 15-16  
 Limits  
   Attaching 21-9  
   Creating 21-7  
 Limits comparison after Compute Center 22-7  
 Limits comparison of existing data 3-36  
 Limits on phase tests 5-5  
 Limits, checking after compute 22-2  
 Line spacing  
   FFT 13-5  
 Line styles, graph 20-13  
 Linear regulation algorithm 3-29  
 Linearity 22-5  
 Lipshitz 10-20  
 Load impedance reference value, analyzer 5-22  
 Load impedance value for dBm units 4-29  
 Load impedance, analyzer 5-22  
 Load LAST.TST on startup 3-38  
 Loading recently used files 3-16  
 Loading waveform files 14-31, 15-25, 16-16  
 Lock flag 8-8  
 Log data features 3-38  
 Log file  
   Viewing 3-50  
 Log file introduction 3-43  
 Log files  
   Clearing 3-50  
 Log/lin



- X axis 19-4
- Y axis 19-17
- Logic outputs
  - DCX-127 25-10
- Loose triggering, FASTTEST 15-14
- Loss measurements on analog devices 5-16
- Loss measurements, DSP analyzer 11-7
- Loss of sync lock indicator 17-5
- Loudspeaker monitoring control 3-24
- Low frequency filters, DSP Audio Analyzer 11-12
- Low pass filter control, analyzer 5-19
- Lowpass filters, DSP analyzer 11-13

## M

- M,W,B preamble 8-18
- Main Meter Function Selection, Display, and Units Selection (ANALYZER) 11-6
- MAKEWAV3 15-26
- Making limit and sweep files with data editor 21-1
- Manual range selection, reading meter 5-17
- Manual range setting
  - DCX-127 DMM 25-2
- Manual range setting, analyzer inputs 5-4
- Masking function, FASTTEST 15-8
- Master clock out, adding jitter 17-7
- Master clock output 9-8
- Max-min, readings bargraph 20-20
- Max/min reset
  - Bargraph 3-20
- Maximizing FFT resolution on zoom 3-40, 13-11
- Maximizing resolution of FFT after zoom 3-35, 13-11
- Maximum (Compute) 22-10
- Maximum algorithm, regulation 3-30
- Measurement (FASTTEST) 15-8
- Measurement function selection
  - DCX-127 25-3
- Measurement function selection, reading meter 5-6
- Measurement functions, digital domain 11-6
- Measurement of jitter 8-11
- Measurement of sync input frequency 17-5
- Measurement source selection 5-3
- Measurement units 18-1 - 18-10
- Measurement, digital input voltage 8-11
- Measurement, input sample rate 8-10
- Measurements at single points 19-6
- Measurements vs. time 19-12
- Measuring DC voltage 25-7
- Measuring delay between input and reference 17-5
- Menu bar 2-1
- Metafile export 3-14
- Meter reading rate control 5-18
- Meter, Level (hardware) 5-26
- Meter, phase (hardware) 5-26
- Meters active during sweeps 3-40
- Meters function during sweep 3-38
- Meters, level (analog) 5-4
- Microphone testing, response matching at different sensitivity 22-6
- Microsoft .WAV file creation, multitone 15-32
- Minimum (Compute) 22-10
- Minimum amplitude error FFT window 14-9
- Minimum frequency step size

- External sweeps 19-11
- Minimum level
  - External sweeps 19-10
- Minus normal regulation algorithm 3-30
- Mono waveform file 14-29, 15-22, 16-15
- Monotonicity waveform, digital 10-13
- Move to bin center “window” 14-10
- Moving data up or down the graph (Compute Normalize) 22-3
- Multi-function interface unit panel 25-1 - 25-4
- Multi-tone signals
  - Creating 15-26
- Multiple lines on graph 19-18
- Multiple sweeps 19-24
- Multiplier value
  - Log sweep 19-5
- Multitone audio analyzer (FASTTEST) 15-4
- Multitone phase measurements 15-21
- Multitone post-processing and sending data to computer 3-35, 13-11
- Multitone signal burst length 15-16
- Multitone signals 15-2
- Mute control, analog generator 4-25
- Muting digital generator output 10-19

## N

- Narrow-band noise waveform 4-21
- Narrowband filter, DSP analyzer 11-9
- Nested sweeps 19-24
- New file 3-1
- No Compute Performed error 22-1
- No FFT window (rectangular) 14-10
- No graph for single point “sweeps” 19-6
- No graph mode 19-23
- Noise
  - Pink 4-20, 10-12
  - Random and pseudorandom 4-19
  - White 4-20
- Noise bandpassed waveform 4-21
- Noise function, FASTTEST 15-8
- Noise generator Overview 4-19
- Noise reduction by averaging, FFT 14-16
- Noise weighting filters, DSP analyzer 11-15
- Noise, normal mode at digital output 8-15
- None, move to bin center “window” 14-10
- Normal mode noise digital output 8-15
- Normal triggering, FASTTEST 15-14
- Normalize 22-3
- Notched amplitude measurements 5-7
- Number of passes, Compute Smooth 22-4
- Number of steps
  - Sweep 19-5
- Numeric data export 3-12

## O

- Occupied bandwidth, interface signal 8-34
- Octave units 18-6
- Off-on control, analog generator 4-25
- Off/on control of DCX-127 DC outputs 25-3
- Offset and scale values for f(V), f(O) 25-3
- Ohms measurements 25-6 - 25-7
- Ohms units 18-8, 25-2
- Ohms/Volts selection
  - DMM 25-3
- Open waveform 14-31, 15-25, 16-16

- Opening files 3-1
  - Optimize 20-4
  - Optional filter control, analyzer 5-20
  - Optional filters
    - Slot designation 3-49
  - Orientation of toolbar 2-3
  - Origin code, transmitting 8-48
  - Original and computed data, viewing 22-2
  - Oscilloscope mode 13-3
  - Oscilloscope trigger
    - AES/EBU signal 9-8
  - Out of range indicator, sync 17-5
  - Out to in offset
    - Switchers 24-4
  - Output cable simulation, digital 8-16
  - Output channel
    - Switcher 24-3
  - Output channel selection, analog generator 4-25 - 4-26
  - Output common mode signal 8-16
  - Output configuration, analog generator 4-27
  - Output delay from ref 17-6
  - Output format, digital 7-8, 8-13
  - Output frequency, analog generator 4-24
  - Output impedance selection 4-29
  - Output interfering noise 8-15
  - Output jitter
    - Jitter output 8-17
  - Output modes
    - Switcher 24-3
  - Output on/mute, analog generator 4-25
  - Output on/off, digital generator 10-19
  - Output parameters 8-12
  - Output preemphasis, digital 7-9
  - Output resolution, digital 7-8
  - Output rise/fall time 8-15
  - Output sample rate 8-14
  - Output stage, analog generator 4-34
  - Output switcher 24-11
  - Output switcher control 24-1
  - Output voltage, digital 8-14
  - Overview
    - DSP Hardware Architecture 6-1
    - Noise generator 4-19
    - Wow & flutter meter 5-11
  - Overview, analog analyzer 5-23
  - Overview, analog generator 4-31
  - Overview, digital analyzer 7-9
  - Overview, reading meter hardware 5-27
- P**
- Page n View 3-23
  - Page setup 3-16, 20-25
  - Page tabs 2-2
  - Panel
    - DCX-127 25-1 - 25-4
    - Diagnostic 3-27
    - Sweep 19-1 - 19-32
    - Switcher 24-1
  - Panel toolbar
    - Viewing 3-22
  - Panel, analog analyzer 5-1
  - Panel, analog generator 4-1
  - Panel, digital generator 10-1
  - Panel, digital I/O 8-3
  - Panel, status bytes 8-46
  - Panels menu 3-23
  - Panels, copying to Windows clipboard 3-19
  - Panic button 3-50
  - Parallel input
    - DSP 9-2
    - timing 9-3

- Parallel output
  - DSP 9-4
  - timing 9-5
- Parallel port
  - DSP 9-1
  - sample rate 9-5
- Parallel port pin assignments, DSP 9-2
- Parameter to be swept 19-3 - 19-5
- Parity error, transmitting 8-15
- Parity flag 8-8
- Pass thru function, digital generator 10-16
- Pass-thru waveform 4-23
- Pass/fail limits
  - Attaching 21-9
- Passes, Compute Smooth 22-4
- Patch point switcher 24-11
- Peak level monitors 7-6
- Peak level monitors, FASTTEST 15-8
- Peak level monitors, FFT 14-5
- Peak picking 13-9
- Peak values function, FFT 14-20
- Percent units 18-5
- Perfect linearity, deviation from 22-5
- Phase (FASTTEST), interchannel vs independent 15-18
- Phase display, FASTTEST 15-21
- Phase measurements, DSP Audio Analyzer 11-10
- Phase meter hardware 5-26
- Phase meter ranges 5-5
- Phase units 18-7
- Pink noise 4-20, 10-12
- Plotting two measured values against one another 19-22
- Plug-in filter selection, analyzer 5-20
- Plug-in filters
  - Slot designation 3-49
- Plus normal regulation algorithm 3-30
- Points vs. FFT bins 13-9
- Polarity (triggering), FFT 14-23
- Polarity inversion of digital generator channels 10-19
- Polarity inversion, analog generator 4-26
- Ports A, B, C control of DCX-127 25-5
- Post-FFT processing 3-35, 13-11
- Postscript file, printing to 20-34
- Power (dBm) unit reference, generator 4-29
- Power (Watts) reference value, generator 4-30
- Power (Watts) unit reference value 5-22
- Power averaging, FFT 14-14
- Power units (dBm) reference value, analyzer 5-22
- PPM (frequency) units 18-6
- PPM units 18-5
- Pre-Trigger Time (FFT) 14-23
- Preamble triggering, INTERVU 8-29
- Preamble, AES/EBU 8-18
- Preferences (utilities configuration) 3-38
- Preview, graph printing 20-32
- Print file 3-16
- Print setup, saving and loading 20-31
- Print to file 20-34
- Printer setup 3-16
- Printing graphs 20-24
- Printing setup for graphs 20-25
- Printing tabular data 20-23, 21-5
- printing test name 20-27
- Probability graph, interface rate 8-42
- Probability of interface jitter 8-44
- Probability vs. pulse width 8-41
- Procedure
  - Saving 3-6

Procedure Editor 3-27  
 Procedure language help 3-52  
 Procedure toolbar  
     Viewing 3-22  
 Process without new FFT 3-35, 13-11  
 Processing (FASTTEST) 15-13  
 Processor settling with multitone testing  
 15-16  
 Production test report (log file) 3-43  
 Program control outputs  
     DCX-127 25-11  
 Prompt to save test 3-38  
 Pseudo and random noise 4-19  
 Pseudorandom noise signals 4-19  
 Pulse amplitude measurement, digital  
 input 8-11  
 Pulse rise/fall time variability 8-15  
 Pulse width probability 8-41

## Q

Quasi-AC coupling, FFT 14-12  
 Quitting APWIN 3-16

## R

Random jitter 8-17  
 Random noise overview 4-19  
 Random noise signals 4-19  
 Random waveform & BITTEST 12-3  
 Random waveform for BITTEST 10-15  
 Range control, DSP analyzer reading  
 meter 11-10  
 Range selection, DSP Audio Analyzer  
 11-6  
 Ranges, phase 5-5  
 Ranging concepts 5-31  
 Rate control, analyzer meters 5-18  
 Rate, digital output 8-14  
 Ratio function, reading meter 5-16  
 Ratio units 18-5  
 Re-align mode, FFT synchronous  
 averaging 14-19  
 Re-graph data 3-36  
 Re-process FFT data on zoom 3-40,  
 13-11  
 Re-set 3-37  
 Re-setting hardware 3-37  
 Re-transforming FFT 3-34, 13-10  
 Reading meter amplitude function 5-7  
 Reading meter bandpass function 5-7  
 Reading meter bandreject function  
 5-7  
 Reading meter channel selection 5-6  
 Reading meter crosstalk function 5-17  
 Reading meter detector hardware  
 5-30  
 Reading meter function selection 5-6  
 Reading meter hardware overview  
 5-27  
 Reading meter ranging control and  
 manual selection 5-17  
 Reading meter ratio function 5-16  
 Reading meter THD+N function 5-8  
 Reading rate  
     DCX-127 25-3  
 Reading rate control, analog meters  
 5-18  
 Readings (sweep), ANALYZER 11-17  
 Readings active during sweeps 3-40  
 Readings bargraph 20-20  
 Readings, FASTTEST 15-19  
 Readings, FFT 14-26  
 Real-time phase measurements, digital  
 or analog 11-10  
 Received status bytes 8-49  
 Recent file 3-16

- Record length 13-6
- Record length, FFT 14-5
- Rectangular FFT window 14-10
- Rectangular probability function dither
  - Selecting 10-20
- Reference dBr
  - Analog analyzer setting 3-20
- Reference frequency, analog generator 4-30
- Reference frequency, digital generator 10-21
- Reference impedance for Watts, generator 4-30
- Reference input frequency 17-4
- Reference input termination 17-4
- Reference input, digital 17-3
- Reference output, AES/EBU 17-6
- Reference sample rate for audio frequency measurements 7-5
- Reference value for analog generator dBr units 4-30
- Reference value for generator dBm units 4-29
- Reference value for generator relative frequency units 3-20
- Reference, delaying generator from 17-6
- Reference-to-input delay measurement 17-5
- Regulated parameter, regulation function 3-28
- Regulation -normal algorithm 3-30
- Regulation “by varying” value 3-29
- Regulation and sweeps 3-31
- Regulation applications 3-31
- Regulation function 3-27
- Regulation function algorithms 3-29
- Regulation function, +normal algorithm 3-30
- Regulation function, maximum algorithm 3-30
- Regulation linear algorithm 3-29
- Regulation minimum algorithm 3-30
- Regulation target value 3-28
- Regulation timeout parameter 3-31
- Regulation tolerance 3-28
- Relative dB
  - Setting generator reference 3-20
- Relative dB (dBr) reference value, analog analyzer 5-21
- Relative dB reference setting 3-20
- Relative dB unit (dBr) reference, analog generator 4-30
- Relative distortion measurements 5-8
- Relative frequency
  - Setting analyzer reference 3-20
  - Setting generator reference 3-20
- Relative frequency reference value, analog analyzer 5-23
- Relative frequency units 18-6
- Relative frequency units reference, digital generator 10-21
- Relocating toolbar 2-3
- Reminder to save test 3-38
- Remote generator
  - Sweeping from 19-8
- Remove text 3-18
- Removing log files 3-50
- Repeatability
  - Sweeps 19-25
- Repeated sweeps 19-7
- Repeating sweeps 3-34
- Replacing Audio Precision in graph title 3-38
- Replacing deleted text 3-18
- Reprocess data 3-35, 13-11
- Reset bar graph max/min 3-20

- Resistance measurements 25-6 - 25-7
  - Resistance units 18-8
  - Resistance, AES/EBU input 8-10
  - Resolution
    - FFT 13-5
    - Sweep 19-5
  - Resolution improvement of FFT after zoom 3-35, 13-11
  - Resolution vs speed
    - DMM 25-3
  - Resolution, digital input 7-4
  - Resolution, digital output 7-8
  - Response function, FASTTEST 15-8
  - Response, analog analyzer detector 5-19
  - Restore hardware utility 3-37
  - Restoring generator outputs 3-50
  - Restoring saved waveforms 14-31, 15-25, 16-16
  - Results files
    - Displaying 3-50
  - Results summary files
    - Clearing 3-50
  - Revision number
    - APWIN 3-53
  - Rife-Vincent window 14-10
  - Rise and fall time measurement of interface 8-35
  - Rise/fall time variations, pulse output 8-15
  - Rounding digital output 7-8
  - Rratio measurements, DSP analyzer 11-7
- S**
- Sample rate
    - DSP parallel port 9-5
  - Sample rate for digital domain arbitrary waveforms 10-17
  - Sample rate measurement 8-10
  - Sample rate, digital output 8-14
  - Sample rate, FASTTEST A/D 15-5
  - Sample rate, setting for generator waveforms 3-41
  - Save file 3-7
  - Save LAST.TST on exit 3-38
  - Save procedure 3-6
  - Save test reminder 3-38
  - Save waveform 14-29, 15-22, 16-15
  - Saving last test automatically 3-39
  - Saving tests 3-6
  - Scale and offset values for f(V), f(O) 25-3
  - Scale factor for “function of X” 25-5
    - DCX-127 25-4
  - Scale frequency by 7-5
  - Scaling digital generator amplitude to analog values 10-19
  - Scrape flutter measurement control 5-12
  - Scrape flutter theory of operation 5-15
  - Screen overview 2-1
  - Selecting analog analyzer detector types 5-19
  - Selecting analog analyzer high-pass filter 5-19
  - Selecting analog analyzer input source 5-3
  - Selecting analog analyzer low pass filter 5-19
  - Selecting analog generator output channels 4-25 - 4-26
  - Selecting analog generator waveforms 4-2
  - Selecting DCX-127 digital format 25-4

- Selecting DCX-127 digital output data format 25-4
- Selecting digital generator output channels 10-18
- Selecting digital generator waveforms 10-2
- Selecting generator impedance 4-29
- Selecting measurement function, reading meter 5-6
- Selecting transmitted channel status bytes 8-48
- Selection of parameter to be swept (Source 1) 19-3 - 19-5
- Selective amplitude measurement 5-7
- Selective amplitude measurements, DSP analyzer 11-9
- Selectivity
  - FFT (window concepts) 13-8
- Selectivity selection
  - FFT programs 14-7
- Sequence of compute operations 22-2
- Serial Interface Adaptor
  - SIA-322 9-1, 9-9
- Set Analyzer dBr Ref 3-20
- Set analyzer freq ref 3-20
- Set generator dBr ref 3-20
- Set generator freq ref 3-20
- Set preferences (utilities configuration) 3-38
- Set sample rate when loading generator waveform 4-22, 10-17
- Set working directory 3-10
- Setting dc output levels
  - DCX-127 25-3
- Setting tone burst parameters 4-6, 10-4
- Setting up printer 3-16
- Settings (sweep), ANALYZER 11-17
- Settings bargraph 20-20
- Settings bargraph increment size 20-21
- Settings, analog analyzer 5-1
- Settings, FASTTEST 15-19
- Settings, FFT 14-26
- Settling
  - Sweep 19-25
- Settling delay 19-30
- Setup for printing graphs 20-25
- Shaped burst 4-14, 10-5
- Shaped dither
  - Selecting 10-20
- Show panel (sweep) 3-33
- Show settling panel 3-33
- Showing data when test is opened 3-38
- SIA-2322, adding jitter 17-7
- SIA-322 Serial Interface Adaptor 9-1, 9-9
- Side lobes
  - Blackman-Harris window 14-8
- Signal acquired output
  - DCX-127 25-11
- Signal Duration Requirements (FASTTEST) 15-16
- Signal level changes while monitoring, DSP audio analyzer 11-6
- Signal selection, digital generator 10-2
- Signal waveform selection, analog generator 4-2
- Simulated digital output cable attenuation 8-16
- Simulated output common mode signal 8-16
- Simulated output jitter 8-17
- Sine plus DC, digital domain 10-7
- Sine shaped burst 4-14, 10-5
- Sinewave burst control 4-6, 10-4
- Sinewave bursts
  - Gated 4-9



- Triggered 4-8
- Sinewave jitter 8-17
- Sinewaves and BITTEST 12-3
- Single channel parallel i/o 9-5
- Single-point “sweeps” 19-6
- Single-point sweep, external 19-6
- Six parameters
  - Displaying 19-23
- Size field, digital generator 10-20
- Sliding FFT beginning point 14-22
- Slots
  - Designating filter installed 3-49
- Smoothing data 22-4
- SMPTE IMD 4-15, 5-9, 10-10
- SMPTE IMD, DSP Audio Analyzer 11-9
- SMPTE/DIN IMD, digital domain 10-11
- Sockets: Designating filter installed 3-49
- Software controlled outputs 25-11
- Software version number
  - APWIN 3-53
- Sound card A/D converter testing 15-26
- Source (FASTTEST) 15-6
- Source (FFT) 14-3
- Source (MLS) 16-6
- Source 1 parameter 19-3 - 19-5
- Source impedance selection 4-29
- Source parameters, FASTTEST 15-19
- Source parameters, FFT and FASTTEST 14-26
- Spacing
  - External sweeps 19-11
- Span
  - Sweep 19-4
- Speaker/headphone panel 3-24
- Specifying filter-to-socket relationship 3-49
- Spectral averaging, FFT 14-14
- Spectrum analysis 13-5
  - Spectrum analysis of jitter 8-36
  - Spectrum analysis of wow & flutter 5-16
  - Spectrum analysis, FFT 14-1
  - Spectrum analysis, interface signal 8-34
  - Spectrum function, FASTTEST 15-8
  - Spot measurements 19-6
  - Squarewave generator 4-18, 10-9
  - Stabilized data 19-25
  - Staircase waveform, digital 10-13
  - Standard toolbar
    - Viewing 3-22
  - Start 3-33
  - Start and stop values, Compute Linearity 22-5
  - Start sweep 19-7
  - Start Time (FFT) 14-22
  - Start value of sweep 19-4
  - Start with Append 3-33
  - Start with repeat 3-34
  - Starting with previous test already loaded 3-39
  - Statistics, multitone waveform 15-32
  - Status
    - Hardware 3-38
  - Status bar 3-23
  - Status bar/tabs 2-2
  - Status bits panel 8-46
  - Status block triggering, INTERVU 8-29
  - Status byte display, hexadecimal 8-50
  - Status byte display, input 8-49
  - Status byte output selection 8-48
  - Steering BP-BR filter frequency 5-21
  - Steering, DSP analyzer filter 11-10
  - Step size
    - Lin sweep 19-5

- Step size, changing setting by arbitrary value 20-21
- Step tables 19-13
- Steps value
  - Sweep 19-5
- Stereo separation measurements on analog-output devices 5-17
- Stereo separation measurements, DSP analyzer 11-8
- Stereo separation, multitone waveforms for 15-33
- Stereo sinewave, digital 10-6
- Stereo sinewaves, analog 4-13
- Stereo sweeps 19-19
- Stereo waveform file 14-29, 15-22, 16-15
- Stop 3-33
- Stop sweep 3-33
- Stop value of sweep 19-4
- Stopping external sweeps 19-11
- Stuck bits 7-7
- Subtract Average Value (FFT) 14-12
- Subtracting one data set from another 22-7
- Suffix
  - File 3-17
- Sweep data logging 3-43
- Sweep direction
  - External sweeps 19-10
- Sweep gate output
  - DCX-127 25-11
- Sweep menu 3-32 - 3-36
- Sweep range 19-4
- Sweep resolution 19-5
- Sweep settings and readings (ANALYZER) 11-17
- Sweep Settings and Readings (FFT) 14-26
- Sweep Settings and Readings (INTERVU) 8-20
- Sweep settings and readings, FASTTEST 15-19
- Sweep settling 19-25
- Sweep speed
  - Improving 3-40
- Sweep start 3-33
- Sweep table creation, multitone 15-31
- Sweep tables, editing 19-15, 21-10
- Sweep timeout 19-25
- Sweeping bandpass filter, analog analyzer 5-21
- Sweeping from zoom results 20-5
- Sweeps
  - Arbitrary step values 19-13
  - External 19-8
  - Repeating 19-7
  - Testing at exact values 19-13
  - Updating meter readings during 3-38
- Sweeps and regulation 3-31
- Sweeps, fast 11-14
- Sweeps, stereo 19-19
- Swept parameter 19-3 - 19-5
- Switcher address settings 24-14
- Switcher connections to multi-track recorder 24-8
- Switcher control during sweeps 24-5
- Switcher hardware 24-9
- Switcher input channel 24-2
- Switcher installation 24-14
- Switcher jumper selection 24-13
- Switcher output channel 24-3
- Switcher output modes 24-3
- Switcher panel 24-1
- Switches
  - Patch point switchers 24-16
- Sync input frequency 17-4

- Sync input frequency measurement 17-5
  - Sync input termination 17-4
  - Sync input, digital 17-3
  - Sync out of range indicator 17-5
  - Sync unlocked indicator 17-5
  - Sync, delaying generator from 17-6
  - Sync-Ref panel 17-1
  - Sync-to-input delay measurement 17-5
  - Synchronization, AES/EBU 8-18
  - Synchronized tone bursts 4-8
  - Synchronous averaging 14-16
  - Synchronous FFTs
    - Window selection 14-10
  - Synchronous rms detector 11-14
- T**
- T on graph 19-25
  - Table sweeps 19-13
  - Tabs
    - Page 2-2
  - Tabular data printing 20-23
  - Tabular data printout 21-5
  - Tabular display for single-point “sweeps” 19-6
  - Tape machine playback
    - Sweeping from 19-8
  - Target range, bargraph 20-20
  - Target value, Compute Normalize 22-3
  - Target value, regulation function 3-28
  - Termination impedance, sync/reference input 17-4
  - Termination resistance, AES/EBU input 8-10
  - Termination resistance, input 5-3
  - test file extension 3-6
  - test name, printing 20-27
  - Test report (log file) 3-43
  - Test tapes
    - Sweeping from 19-8
  - THD+N measurements, reading meter 5-8
  - THD+N, digital domain signals 11-9
  - Theory
    - Scrape flutter 5-15
    - Wow & flutter 5-14
  - Tight triggering, FASTTEST 15-14
  - Tile 3-51
  - TIM IMD 4-15, 5-10, 10-10
  - Time domain averaging 14-16
  - Time domain display 13-3
  - Time domain view of interface 8-35
  - Time sweeps 19-12
  - Time units 18-8
  - Time-selective FFT analysis 14-22
  - Timeout
    - Sweep 19-25
  - Timeout parameter, regulation function 3-31
  - Timing
    - parallel output 9-5
  - Timing diagram
    - parallel input 9-3
  - Title and labels, graph 20-8
  - Tolerance
    - Sweep settling 19-29
  - Tone burst control 4-6, 10-4
  - Tone bursts
    - Gated 4-9
    - Triggered 4-8
  - Toolbar viewing
    - Panel 3-22
    - Procedure 3-22
    - Standard 3-22
  - Total jitter measurement 8-11
  - Trace colors 20-11
  - Track channel A, digital generator

10-19  
 Track control, analog generator channel amplitude 4-26  
 Tracking filter for signals 11-10  
 Transfer APWIN text to other programs 3-18  
 Transform buffer  
     Saving 14-30, 15-23  
 Transform data without acquire 3-34, 13-10  
 Transform Length (FFT) 14-5  
 Transform length vs. resolution  
     FFT 13-5  
 Transform length, FASTTEST 15-13  
 Transmit frame sync inversion 17-6  
 Transmitted status bits channel selection 8-48  
 Transmitting new FFT data from DSP to computer 3-35, 13-11  
 Transmitting origin and destination codes in status bytes 8-48  
 Traveler (log file) 3-43  
 Triangular probability function dither  
     Selecting 10-20  
 Trigger (INTERVU) 8-29  
 Trigger Delay (FASTTEST) 15-16  
 Trigger output signal  
     DCX-127 25-11  
 Trigger output, DSP programs 9-8  
 Trigger polarity, FFT 14-23  
 Trigger source, MLS 16-14  
 Triggering (FASTTEST) 15-14  
 Triggering on multitone signals 15-12  
 Truncation, digital input signal 7-4  
 Turn all outputs off 3-50  
 Turn outputs back on 3-50  
 Turning analog generator outputs off 4-25

Turning off graph 19-23  
 Twin tone IMD 4-15, 5-10, 10-10  
 Twin tone signal, digital 10-6  
 Two-tone signals, analog 4-14

## U

UI units 18-8  
 Unbalanced Inputs 5-26  
 Unbalanced output, analog generator 4-27  
 Undo 3-18  
 Unit interval units 18-8  
 Units  
     %FS 18-7  
     Amplitude 18-1  
     Bits 18-7  
     dBFS 18-7  
     DC volts 18-8  
     DCX-127 amplitude 18-8  
     DCX-127 digital 18-8  
     Digital domain amplitude 18-7  
     FFS 18-7  
     Function of Ohms 18-8  
     Function of Volts 18-8  
     Ohms 18-8  
     Phase 18-7  
     Ratio 18-5  
     Resistance 18-8  
     Time 18-8  
     Unit interval 18-8  
 Units of measure 18-1 - 18-10  
 Units selection  
     DCX-127 digital input 25-4  
     DCX-127 digital output 25-4  
 Units, digital generator amplitude 10-19  
 Units, FASTTEST 15-19  
 Units, FFT 14-26  
 Units:Frequency 18-6

Unwrapped phase 5-5  
 Updating meters during sweeps 3-38  
 Upside down data 22-4  
 Using help 3-52  
 Using the Data Editor to create limit and sweep files 21-1  
 Utilities configuration menu 3-38  
 Utilities filters 3-49  
 Utilities Menu 3-37 - 3-50

## V

V/FS digital reference 14-26, 15-19  
 V/FS scaling factor, ANALYZER 11-17  
 Validity bit 8-8  
 Vanderkooy 10-20  
 Variable amplitude noise at digital output 8-15  
 Variable DC output 25-8  
 Variable dc output control 25-3  
 Variable output pulse amplitude, digital 8-14  
 Variable phase sinewaves, analog 4-13  
 Variable phase sinewaves, digital 10-6  
 Variable rise/fall, digital output 8-15  
 VCA control 25-8  
 Vector graph export 3-14  
 Version number  
   APWIN 3-53  
 Vertical toolbar 2-3  
 Video sync 17-3  
 View log file 3-50  
 View menu 3-21 - 3-22  
 View Page n 3-23  
 Viewing original and computed data 22-2  
 Viewing waveform statistics, multitone 15-32  
 Voltage (DC) measurements 25-7

Voltage measurement, digital pulse input 8-11  
 Voltage, variable at digital output 8-14  
 Voltmeters, analog input 5-4  
 Volts units 18-1  
 Volts/FS reference, digital generator 10-21  
 Volts/FS scale factor 10-19  
 Vp units 18-2  
 Vpp units 18-2  
 Vrms units 18-1

## W

W&F spectrum analysis 14-3  
 Walking ones & zeros 10-15  
 Walking waveforms & BITTEST 12-3  
 Watts reference, analyzer 5-22  
 Watts reference, generator 4-30  
 Watts units 18-2  
 WAV file creation, multitone 15-32  
 Wave display, FFT 14-20  
 Waveform  
   Save to disk 14-29, 15-22, 16-15  
 Waveform display 13-3, 14-1  
 Waveform display of interface signal (INTERVU) 8-35  
 Waveform display of jitter signal (INTERVU) 8-38  
 Waveform Display Processing (FFT) 14-20  
 Waveform Display Processing (INTERVU) 8-23  
 Waveform file length 14-30, 15-23  
 Waveform files  
   Combining 14-31, 15-24, 16-16  
   Creating 15-26  
 Waveform selection, analog generator

- 4-2
- Waveform selection, digital generator 10-2
- Weighting filter frequencies vs sample rate, DSP Audio Analyzer 11-16
- Weighting filter selection, analog analyzer 5-20
- Weighting filters, DSP analyzer 11-15
- White noise 4-20
- White noise interference at digital output 8-15
- white vs black background, graph 3-19
- Width, digital output word 7-8
- Window (FFT)
  - Blackman Harris 14-8
  - Flat-top 14-9
  - Hann 14-7
  - None 14-10
- Window (FFT) concepts 13-8
- Window menu 3-51
- Window selection for synchronous signals 14-10
- Window shape selection 14-7
- Windowing Function (FFT) 13-7
- Windows
  - Close all 3-51
- Word width display, input 7-7
- Word width, digital output 7-8
- Word width, input 7-4
- Worst-case crosstalk
  - Switcher 24-3
- Wow & flutter FFT 5-16
- Wow & flutter measurement control 5-12
- Wow & flutter meter overview 5-11
- Wow & flutter theory of operation 5-14
- Wow and flutter, 2-sigma computation 22-8
- Wrapped phase 5-5

- Wrong waveform displays due to graphic aliasing 13-4

## X

- X,Y,Z preamble 8-18
- X-axis parameter 19-3 - 19-5
- X/Y units 18-5

## Y

- Y axis divisions 19-17
- Y axis log vs. lin 19-17
- Y-axis autoscale
  - Graph 19-17

## Z

- Zoomout 20-3



Audio Precision  
PO Box 2209  
Beaverton, Oregon 97075-2209  
Tel: (503) 627-0832 Fax: (503) 641-8906  
US Toll Free: 1-800-231-7350  
email: [techsupport@audioprecision.com](mailto:techsupport@audioprecision.com)  
Web: [www.audioprecision.com](http://www.audioprecision.com)